

## Network Interface Board

# CC-Link IE Field Network Interface Board User's Manual (For SW1DNC-CCIEF-B)

---

-Q80BD-J71GF11-T2  
-Q81BD-J71GF11-T2

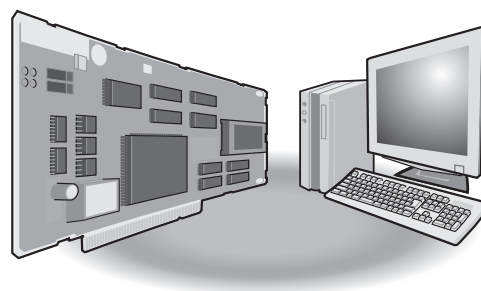



# SAFETY PRECAUTIONS

---



(Read these precautions before using this product.)

Before using this product, please read this manual and the relevant manuals carefully and pay full attention to safety to handle the product correctly. If the equipment is used in a manner not specified by the manufacturer, the protection provided by the equipment may be impaired.

The precautions given in this manual are concerned with this product only. For the safety precautions of the programmable controller system, refer to the user's manual for the CPU module used.

In this manual, the safety precautions are classified into two levels: "⚠ WARNING" and "⚠ CAUTION".

---

 <b>WARNING</b>	Indicates that incorrect handling may cause hazardous conditions, resulting in death or severe injury.
 <b>CAUTION</b>	Indicates that incorrect handling may cause hazardous conditions, resulting in minor or moderate injury or property damage.

---

Under some circumstances, failure to observe the precautions given under "⚠ CAUTION" may lead to serious consequences.

Observe the precautions of both levels because they are important for personal and system safety.

Make sure that the end users read this manual and then keep the manual in a safe place for future reference.

## [Design Precautions]

---

### **WARNING**

---

- Configure safety circuits external to the programmable controller to ensure that the entire system operates safely even when a fault occurs in a personal computer. Failure to do so may result in an accident due to an incorrect output or malfunction.
    - (1) Emergency stop circuits, protection circuits, and protective interlock circuits for conflicting operations (such as forward/reverse rotations or upper/lower limit positioning) must be configured external to the programmable controller.
    - (2) The station to which the board is installed may be disconnected from the data link due to a data link error. If this occurs, the data output from the station and written to other stations before the error will be held until the station is reconnected to the network (until its data link is restarted). Provide a mechanism for data link status monitoring and error handling for each station that is connected to the data link system.
  - For the operating status of each station after a communication failure, refer to this manual. Incorrect output or malfunction due to a communication failure may result in an accident.
  - When changing data during operation, configure an interlock circuit in the program to ensure that the entire system will always operate safely. And determine corrective actions to be taken between the personal computer and CPU module in case of a communication failure.
- 

## [Design Precautions]

---

### **CAUTION**

---

- Do not install the control lines or communication cables together with the main circuit lines or power cables.  
Keep a distance of 100mm or more between them. Failure to do so may result in malfunction due to noise.
-

## [Security Precautions]

---

### **WARNING**

- To maintain the security (confidentiality, integrity, and availability) of the programmable controller and the system against unauthorized access, denial-of-service (DoS) attacks, computer viruses, and other cyberattacks from external devices via the network, take appropriate measures such as firewalls, virtual private networks (VPNs), and antivirus solutions.
- 

## [Installation Precautions]

---

### **WARNING**

- Turn off the power for the system in all phases before installing the board to or removing it from the personal computer. Failure to do so may result in electric shock or cause the board to fail or malfunction.
  - Do not touch any connectors while power is on. Doing so may cause electric shock or malfunction.
- 

## [Installation Precautions]

---

### **CAUTION**

- Use the board in an environment that meets the general specifications in this manual. Failure to do so may result in electric shock, fire, malfunction, or damage to or deterioration of the product.
  - Do not directly touch any conductive parts and electronic components of the board. Doing so can cause malfunction or failure of the board.
  - Do not disassemble or modify the boards. Doing so may cause failure, malfunction, injury, or a fire.
  - Fix the board by tightening the board-fixing screws within the specified torque range. Undertightening may cause drop, short circuit, or malfunction. Overtightening may damage the screw and/or board, resulting in drop, short circuit, or malfunction.  
For the tightening torque of the board-fixing screws, refer to the manual supplied with the personal computer.
  - Before handling the board, touch a conducting object such as a grounded metal to discharge the static electricity from the human body. Failure to do so may cause the board to fail or malfunction.
  - Install the board to a personal computer which is compliant with PCI standard or PCI Express<sup>®</sup> standard (  Page 30 Operating Environment). Failure to do so may cause a failure or malfunction.
  - Securely insert the board into the PCI slot following the board installation instruction of the personal computer. Incorrect insertion of the board may cause malfunction, failure, or drop of the board.
  - When installing the board, take care not to contact with other boards.
  - When installing the board, take care not to get injured by an implemented component or a surrounding member.
  - Handle the board in a place where static electricity will not be generated. Failure to do so may cause a failure or malfunction.
  - The board is included in an antistatic envelope. When storing or transporting it, be sure to put it in the antistatic envelope. Failure to do so may cause a failure or malfunction.
  - Do not drop or apply a strong impact to the board. Doing so may cause a failure or malfunction.
-

## [Wiring Precautions]

---

### **WARNING**

- Turn off the power for the system in all phases before installing the board or starting wiring. Failure to do so may result in electric shock, damage to the product, or malfunction.
  - After installation of the board and wiring, attach the cover on the module before turning it on for operation. Failure to do so may result in electric shock.
- 

## [Wiring Precautions]

---

### **CAUTION**

- Place the communication cable connected to the board in a duct or clamp them. If not, dangling cables may swing or inadvertently be pulled, resulting in damage to the board or cables or malfunctions due to poor contact.
  - When disconnecting the cable from the board, do not pull the cable by the cable part. Pulling the cable connected to the board may result in malfunction or damage to the board or cable.
  - Prevent foreign matter such as dust or wire chips from entering the personal computer. Such foreign matter may cause a fire, failure, or malfunction.
  - Do not install the communication cables together with the main circuit lines or power cables. Keep a distance of 100mm or more between them. Failure to do so may result in malfunction due to noise.
  - Securely plug the communication cable to the connector of the board. Then, check for any incomplete connection. Poor contact may cause an erroneous input or output.
  - Always ground the personal computer to the protective ground conductor. Failure to do so may cause a malfunction.
- 

## [Startup and Maintenance Precautions]

---

### **WARNING**

- Turn off the power for the system in all phases before cleaning the board or retightening the board-fixing screws. Failure to do so may result in electric shock, or cause a failure or malfunction of the board.
  - Turn off the power for the system in all phases before installing the board to or removing it from the personal computer. Failure to do so may result in electric shock or cause the board to fail or malfunction.
  - Do not connect or disconnect any communication cable while power is on. Doing so may result in a malfunction.
-

## [Startup and Maintenance Precautions]

---

### **CAUTION**

---

- Thoroughly read the manual and ensure the safety before performing program modification during operation, forced output, operation such as RUN, STOP, and PAUSE. An improper operation will result in mechanical damage or accidents.
- Do not disassemble or modify the boards. Doing so may cause failure, malfunction, injury, or a fire.
- Fix the board by tightening the board-fixing screws within the specified torque range. Undertightening may cause drop, short circuit, or malfunction. Overtightening may damage the screw and/or board, resulting in drop, short circuit, or malfunction.

For the tightening torque of the board-fixing screws, refer to the manual supplied with the personal computer.

- Before handling the board, touch a conducting object such as a grounded metal to discharge the static electricity from the human body. Failure to do so may cause the board to fail or malfunction.
  - The board is included in an antistatic envelope. When storing or transporting it, be sure to put it in the antistatic envelope. Failure to do so may cause a failure or malfunction.
  - The microprocessor built in the board will reach a high temperature during operation. Do not touch it directly when replacing the board. Doing so may result in a failure, malfunction or injury.
- 

## [Disposal Precautions]

---

### **CAUTION**

---

- When disposing of this product, treat it as industrial waste.
-

# CONDITIONS OF USE FOR THE PRODUCT

---

- (1) MELSEC programmable controller ("the PRODUCT") shall be used in conditions;
- i) where any problem, fault or failure occurring in the PRODUCT, if any, shall not lead to any major or serious accident; and
  - ii) where the backup and fail-safe function are systematically or automatically provided outside of the PRODUCT for the case of any problem, fault or failure occurring in the PRODUCT.
- (2) The PRODUCT has been designed and manufactured for the purpose of being used in general industries. MITSUBISHI ELECTRIC SHALL HAVE NO RESPONSIBILITY OR LIABILITY (INCLUDING, BUT NOT LIMITED TO ANY AND ALL RESPONSIBILITY OR LIABILITY BASED ON CONTRACT, WARRANTY, TORT, PRODUCT LIABILITY) FOR ANY INJURY OR DEATH TO PERSONS OR LOSS OR DAMAGE TO PROPERTY CAUSED BY the PRODUCT THAT ARE OPERATED OR USED IN APPLICATION NOT INTENDED OR EXCLUDED BY INSTRUCTIONS, PRECAUTIONS, OR WARNING CONTAINED IN MITSUBISHI ELECTRIC USER'S, INSTRUCTION AND/OR SAFETY MANUALS, TECHNICAL BULLETINS AND GUIDELINES FOR the PRODUCT.
- ("Prohibited Application")
- Prohibited Applications include, but not limited to, the use of the PRODUCT in;
- Nuclear Power Plants and any other power plants operated by Power companies, and/or any other cases in which the public could be affected if any problem or fault occurs in the PRODUCT.
  - Railway companies or Public service purposes, and/or any other cases in which establishment of a special quality assurance system is required by the Purchaser or End User.
  - Aircraft or Aerospace, Medical applications, Train equipment, transport equipment such as Elevator and Escalator, Incineration and Fuel devices, Vehicles, Manned transportation, Equipment for Recreation and Amusement, and Safety devices, handling of Nuclear or Hazardous Materials or Chemicals, Mining and Drilling, and/or other applications where there is a significant risk of injury to the public or property.
- Notwithstanding the above restrictions, Mitsubishi Electric may in its sole discretion, authorize use of the PRODUCT in one or more of the Prohibited Applications, provided that the usage of the PRODUCT is limited only for the specific applications agreed to by Mitsubishi Electric and provided further that no special quality assurance or fail-safe, redundant or other safety features which exceed the general specifications of the PRODUCTS are required. For details, please contact the Mitsubishi Electric representative in your region.
- (3) Mitsubishi Electric shall have no responsibility or liability for any problems involving programmable controller trouble and system trouble caused by DoS attacks, unauthorized access, computer viruses, and other cyberattacks.

# CONSIDERATIONS FOR USE

---

## Interlink transfer and routing functions

CC-Link IE Field Network board cannot be used as a relay station for the interlink transfer function or the routing function. To use these functions, set a network module as a relay station.

## Driver installation and updating

The consistency between the driver and utility cannot be identified, and CC-Link IE Field Network board may not operate properly.

Do not install or update the driver other than the method written in the troubleshooting.

 Page 150 TROUBLESHOOTING

# INTRODUCTION

---

Thank you for purchasing the Mitsubishi Electric network interface boards.

This manual describes the required system configuration, specifications, operating procedure, functions, and troubleshooting of the relevant products listed below.

Before using this product, please read this manual and the related manuals carefully and develop familiarity with the functions and performance of the CC-Link IE Field Network interface board to handle the product correctly.

Note that the menu names and operating procedures may differ depending on an operating system in use and its version.

When reading this manual, replace the names and procedures with the applicable ones as necessary.

Please make sure that the end users read this manual.

## Relevant products

Q80BD-J71GF11-T2, Q81BD-J71GF11-T2

# CONTENTS

SAFETY PRECAUTIONS .....	1
CONDITIONS OF USE FOR THE PRODUCT .....	5
CONSIDERATIONS FOR USE .....	6
INTRODUCTION .....	6
RELEVANT MANUALS .....	12
TERMS .....	13
GENERIC TERMS AND ABBREVIATIONS .....	14
<b>CHAPTER 1 OVERVIEW</b> .....	<b>15</b>
1.1 CC-Link IE Field Network .....	15
1.2 CC-Link IE Field Network Board .....	17
<b>CHAPTER 2 SYSTEM CONFIGURATION</b> .....	<b>19</b>
2.1 System Configuration Using CC-Link IE Field Network Board .....	19
2.2 CC-Link IE Field Network Configuration .....	19
Single network system .....	19
Multi-network system .....	22
Precautions .....	23
2.3 Network Components .....	29
Cables .....	29
Hubs .....	29
2.4 Operating Environment .....	30
<b>CHAPTER 3 SPECIFICATIONS</b> .....	<b>33</b>
3.1 General Specifications .....	33
3.2 Performance Specifications .....	34
3.3 Buffer Memory List .....	35
<b>CHAPTER 4 PROCEDURE BEFORE OPERATION</b> .....	<b>38</b>
4.1 Procedure Before Operation .....	38
4.2 Part Names .....	39
Operation LED .....	40
Connector .....	41
4.3 Installation .....	42
Handling precautions .....	42
Installation environment .....	42
Procedure for replacing mounting brackets .....	43
Board installation .....	43
4.4 Setting Channel Numbers .....	44
4.5 Tests Before Wiring (Standalone Tests of the Board) .....	45
Bus I/F test .....	45
Memory test .....	45
Hardware test .....	46
Self-loopback test .....	47
4.6 Wiring .....	48
Wiring Precautions .....	48
Ethernet cable connection .....	50
4.7 Tests After Wiring .....	52

Loop test .....	52
Cable test .....	53
Communication test .....	54

---

## **CHAPTER 5 FUNCTIONS 56**

<b>5.1 Function List .....</b>	<b>56</b>
<b>5.2 Cyclic Transmission .....</b>	<b>58</b>
Data flow and link device assignment .....	58
Link scan and link refresh .....	61
Assurance of cyclic data integrity .....	62
Input status of data link faulty station setting .....	64
Cyclic transmission stop and restart .....	65
<b>5.3 Transient Transmission .....</b>	<b>66</b>
Communication on the same network .....	66
Communication with different networks .....	67
<b>5.4 SEND/RECV Function .....</b>	<b>68</b>
<b>5.5 Reserved Station Specification and Reserved Station Function Disable Function .....</b>	<b>73</b>
<b>5.6 Error Invalid Station and Temporary Error Invalid Station Setting Function .....</b>	<b>74</b>
<b>5.7 Event Function .....</b>	<b>75</b>
<b>5.8 Loopback Function .....</b>	<b>76</b>
<b>5.9 Driver WDT function .....</b>	<b>77</b>

---

## **CHAPTER 6 INSTALLING AND UNINSTALLING SOFTWARE PACKAGES 78**

<b>6.1 Installation and Uninstallation Precautions .....</b>	<b>78</b>
<b>6.2 Installation .....</b>	<b>79</b>
Obtaining the software .....	79
Installation procedure .....	79
When installation is completed normally .....	79
When installation is aborted or failed .....	80
<b>6.3 Uninstallation .....</b>	<b>81</b>
Uninstallation procedure .....	81
When uninstallation is completed normally .....	81
When uninstallation is failed .....	81

---

## **CHAPTER 7 OVERVIEW OF CC IE FIELD UTILITY 82**

<b>7.1 Overview .....</b>	<b>82</b>
<b>7.2 Menu List .....</b>	<b>83</b>

---

## **CHAPTER 8 SCREEN CONFIGURATION AND BASIC OPERATIONS 84**

<b>8.1 Starting and Exiting .....</b>	<b>84</b>
<b>8.2 Screen Configuration and Basic Operations .....</b>	<b>85</b>
Main frame configuration .....	85
Toolbars .....	86
Work windows .....	87
<b>8.3 Help Function .....</b>	<b>89</b>

---

## **CHAPTER 9 PROJECT MANAGEMENT 90**

<b>9.1 Creating Projects .....</b>	<b>90</b>
<b>9.2 Opening Existing Projects .....</b>	<b>91</b>
<b>9.3 Saving Projects .....</b>	<b>92</b>

9.4	Saving Projects with Compression and Unpacking Projects .....	93
9.5	Deleting Projects .....	95
9.6	Closing Projects .....	95
9.7	Verifying Project Data .....	96
<b>CHAPTER 10 SETTING PARAMETERS</b>		<b>97</b>
10.1	Parameter List .....	97
10.2	Setting Network Parameter .....	98
	Network type and mode .....	99
	Network configuration setting .....	100
	CC IE Field configuration setting .....	103
	Network operation setting .....	112
	Event setting .....	112
	Driver setting .....	114
	Target setting .....	115
	Routing parameters .....	116
<b>CHAPTER 11 OPERATING BOARD ONLINE</b>		<b>120</b>
11.1	Setting Board Channel Numbers .....	120
11.2	Writing/Reading Parameters to/from Board .....	121
11.3	Verifying Parameters of Board and Project .....	122
11.4	Resetting Board .....	122
<b>CHAPTER 12 MONITORING</b>		<b>123</b>
<b>CHAPTER 13 DIAGNOSING BOARD STATUS</b>		<b>125</b>
13.1	Diagnosing Board .....	125
13.2	Diagnosing CC-Link IE Field Network .....	127
	Selecting the diagnostics target .....	128
	Displaying diagnostics screen .....	128
	Communication test .....	138
	Cable test .....	139
	Link start/stop .....	140
	Network event history .....	141
	Reserved station function enable .....	143
	Enable/Disable ignore station errors .....	144
	Remote operation of a selected station .....	145
<b>CHAPTER 14 MELSEC DATA LINK LIBRARY</b>		<b>146</b>
<b>CHAPTER 15 PROGRAMMING</b>		<b>148</b>
15.1	Precautions on Programming .....	148
<b>CHAPTER 16 TROUBLESHOOTING</b>		<b>150</b>
16.1	Error Examples .....	151
16.2	Troubleshooting for Installation/Uninstallation .....	153
	Installation failed .....	153
	Uninstallation failed .....	153
	Action displayed in the screen is not effective while installation .....	155
	When the driver is not installed .....	156

<b>16.3</b>	<b>Troubleshooting for Personal Computer and Utility</b> .....	<b>157</b>
	Personal computer does not start or shuts down .....	157
	Utility does not startup .....	157
	The screen or operation is abnormal .....	158
	The screen for which corrective action is not clear, is displayed .....	159
	Personal computer operates slowly .....	160
<b>16.4</b>	<b>Troubleshooting for Board and Driver</b> .....	<b>160</b>
	Hardware error or board WDT error .....	160
	Driver WDT error .....	160
	Driver does not start .....	161
	Bus error .....	161
<b>16.5</b>	<b>Troubleshooting for Data Link</b> .....	<b>161</b>
	Communication error (ERR. LED is ON/Flashing) .....	161
	User program cannot access CPU modules other than QCPU (Q mode) and MELSEC iQ-R series CPU modules 162	
	Communication cannot be performed occasionally when executing user program .....	162
	Station is disconnected .....	162
	Communication is unstable .....	163
	Station number is duplicated .....	163
<b>16.6</b>	<b>Troubleshooting for Device Access</b> .....	<b>164</b>
	Cyclic transmission cannot be performed .....	164
	Transient transmission cannot be performed .....	165
<b>16.7</b>	<b>Checking method</b> .....	<b>166</b>
	Checking installation environment .....	167
	Check the board installation .....	167
	Checking cables and wiring .....	167
	Checking operation environment .....	167
	Checking personal computer and operating system .....	168
	Checking with Device Manager .....	168
	Checking operations with event viewer .....	169
	Checking channel numbers .....	170
	Checking operations with board diagnostics .....	170
	Checking operations with tests .....	171
	Checking LED status .....	171
	Checking network status with CC-Link IE Field Network diagnostics .....	174
	Checking network status with monitoring link special relays (SB) and link special registers (SW) .....	174
	Checking communication status with monitoring access target device .....	175
<b>16.8</b>	<b>Information Required for Inquiries</b> .....	<b>176</b>
<b>16.9</b>	<b>Error Code List</b> .....	<b>177</b>
<b>APPENDIX</b> .....		<b>186</b>
<hr/>		
<b>Appendix 1</b>	<b>Precautions for Accessing Redundant CPU System</b> .....	<b>186</b>
	Redundant CPU specification .....	186
	Operation at occurrence of system switching .....	186
	Retry processing for the error that occurs during system switching processing .....	187
	Automatic switching of communication path .....	188
<b>Appendix 2</b>	<b>Details of Buffer Memory Addresses</b> .....	<b>192</b>
	Link device area .....	192
	Offset/size information .....	194
	Own station information .....	196

Other station information .....	197
<b>Appendix 3 Link Special Relay (SB) List .....</b>	<b>198</b>
<b>Appendix 4 Link Special Register (SW) List .....</b>	<b>209</b>
<b>Appendix 5 Processing Time .....</b>	<b>226</b>
Link refresh time .....	226
Link scan time .....	227
Transmission delay time .....	227
<b>Appendix 6 Differences in Cyclic Transmission Modes .....</b>	<b>228</b>
<b>Appendix 7 Comparison of CC-Link and CC-Link IE Field Network .....</b>	<b>229</b>
<b>Appendix 8 Combinations with Existing Software .....</b>	<b>231</b>
<b>Appendix 9 Checking Serial Number and Function Version .....</b>	<b>232</b>
<b>Appendix 10 Added and Changed Functions .....</b>	<b>233</b>
Change of hardware function .....	233
Update of software package .....	233
<b>Appendix 11 Windows User Account Control .....</b>	<b>234</b>
Confirmation message .....	234
Methods for displaying a message .....	234
<b>Appendix 12 Behavior When Personal Computer Enters Power Save Mode or Fast Startup .....</b>	<b>235</b>
Behavior when the personal computer enters the power save mode (hibernate, sleep) .....	235
Behavior when fast startup function is enabled .....	235
<b>Appendix 13 MELSEC Power Manager .....</b>	<b>236</b>
Installing MELSEC Power Manager .....	236
Uninstalling MELSEC Power Manager .....	236
Checking MELSEC Power Manager .....	236
<b>Appendix 14 EMC and Low Voltage Directives .....</b>	<b>237</b>
Measures to comply with the EMC Directive .....	237
Measures to comply with the Low Voltage Directive .....	240
<b>Appendix 15 External Dimensions .....</b>	<b>241</b>
Q80BD-J71GF11-T2 .....	241
Q81BD-J71GF11-T2 .....	242
 <b>INDEX .....</b>	 <b>244</b>
REVISIONS .....	246
WARRANTY .....	247
INFORMATION AND SERVICES .....	248
TRADEMARKS .....	248
COPYRIGHTS .....	248

# RELEVANT MANUALS

---

The following manuals are relevant to this product.

Manual name [manual number]	Description
CC-Link IE Field Network Interface Board User's Manual (For SW1DNC-CCIEF-B) [SH-080980ENG] (this manual)	System configuration, specifications, functions, handling, wiring, and troubleshooting for CC-Link IE Field Network interface board
MELSEC Data Link Library Reference Manual [SH-081035ENG]	Programming, function specifications, and sample programming for MELSEC data link library

# TERMS

Unless otherwise specified, this manual uses the following terms.

Term	Description
Baton pass	A control mechanism in which transmission right (token) is passed around the network for data transmission
Buffer memory	Memory in an intelligent function module and network interface board to store data such as setting values and monitor values
CC-Link IE Field Network	A high-speed and large-capacity open field network that is based on Ethernet (1000BASE-T)
Cyclic transmission	A function by which data are periodically exchanged among stations on the same network using link devices (RX, RY, RWw, and RWr)
Data link	Communications that performed by cyclic transmission and transient transmission
Dedicated instruction	An instruction that simplifies programming for using functions of intelligent function modules
Device	A memory of a CPU module to store data. Devices such as X, Y, M, D, and others are provided depending on the intended use.
Device station	Stations, such as a local station, remote I/O station, remote device station, and intelligent device station, other than a master station
Intelligent device station	A station that exchanges I/O signals (bit data) and I/O data (word data) with the master station by cyclic transmission. This station responds to a transient transmission request from another station and also issues a transient transmission request to another station.
Intelligent function module	A module that has functions other than an input or output, such as an A/D converter module and D/A converter module
Link device	A device (RX, RY, RWr, RWw, SB, or SW) in a module and board on CC-Link IE Field Network
Link refresh	Data transfer between link devices of CC-Link IE Field Network board and the driver
Link scan (link scan time)	Time required for all the stations on the network to transmit data. The link scan time depends on data volume and the number of transient transmission requests.
Link special register (SW)	Word data that indicates the operating status and data link status of a module or board on CC-Link IE Field Network
Link special relay (SB)	Bit data that indicates the operating status and data link status of a module or board on CC-Link IE Field Network
Local station	A station that performs cyclic transmission and transient transmission with the master station and other local stations
Loopback	A function that disconnects the station in which an error has occurred, and continues data link with the stations that are operating normally. Stations connected after the faulty station can also continue data link.
Master station	A station that controls the entire network. This station can perform cyclic transmission and transient transmission with all stations. Only one master station can be used in a network.
Relay station	A station that relays data link to other station with mounting more than one network modules on one programmable controller
Remote device station	A station that exchanges I/O signals (bit data) and I/O data (word data) with the master station by cyclic transmission. This station responds to a transient transmission request from another station.
Remote I/O station	A station that exchanges I/O signals (bit data) with the master station by cyclic transmission
Remote input (RX)	Bit data input from a device station to the master station (For some areas in a local station, data are input in the opposite direction.)
Remote output (RY)	Bit data output from the master station to a device station (For some areas in a local station, data are output in the opposite direction.)
Remote register (RWr)	Word data input from a device station to the master station (For some areas in a local station, data are input in the opposite direction.)
Remote register (RWw)	Word data output from the master station to a device station (For some areas in a local station, data are output in the opposite direction.)
Reserved station	A station reserved for future use. This station is not actually connected, but counted as a connected station.
Routing	A process of selecting paths for communication with other networks. CC-Link IE Field Network requires communication paths to be preset using routing parameters to communicate with stations on different networks.
Transient transmission	A function of communication with another station, which is used when requested by a MELSEC data link library or a utility

# GENERIC TERMS AND ABBREVIATIONS

Unless otherwise specified, this manual uses the following generic terms and abbreviations.

Generic term/abbreviation	Description
CC IE Field Utility	A utility included in the SW1DNC-CCIEF-B CC-Link IE Field Network software package
CC-Link IE Controller Network board	Q80BD-J71GP21-SX, Q80BD-J71GP21S-SX, Q81BD-J71GP21-SX, and Q81BD-J71GP21S-SX CC-Link IE Controller Network interface boards
CC-Link IE Field Network board	Q80BD-J71GF11-T2 and Q81BD-J71GF11-T2 CC-Link IE Field Network interface boards
CC-Link Ver.2 board	Q80BD-J61BT11N and Q81BD-J61BT11 CC-Link system master/local interface boards
CPU module	A MELSEC iQ-R series or MELSEC-Q/L series CPU module
Ethernet adapter module	NZ2GF-ETB CC-Link IE Field Network Ethernet adapter module
MD function	Functions in MELSEC data link library
MELSECNET/H board	Q80BD-J71LP21-25, Q81BD-J71LP21-25, Q80BD-J71LP21S-25, Q80BD-J71LP21G, Q80BD-J71LP21GE, and Q80BD-J71BR11 MELSECNET/H interface boards
RAS	Reliability, Availability, and Serviceability. This term refers to usability of automated equipment.
SW1DNC-CCIEF-B	A product name of the software package for CC-Link IE Field Network board
Driver WDT	A watchdog timer that monitors the communication status between a network board and a personal computer, or operating status of a personal computer
Network module	Includes the following: <ul style="list-style-type: none"> <li>• CC-Link IE Field Network module</li> <li>• CC-Link IE Controller Network module</li> <li>• MELSECNET/H module</li> <li>• MELSECNET/10 module</li> </ul>
Head module	LJ72GF15-T2 CC-Link IE Field Network head module
Board WDT	A watchdog timer that monitors the operating status of a network board
Master/local module	QJ71GF11-T2 and LJ71GF11-T2 CC-Link IE Field Network master/local modules
Remote head module	RJ72GF15-T2 CC-Link IE Field Network remote head module

# 1 OVERVIEW

## 1.1 CC-Link IE Field Network

CC-Link IE Field Network is a high-speed and large-capacity open field network that is based on Ethernet technology (1000BASE-T).

### Data communication

High-speed and large-capacity data communication is available between a master station and device stations on CC-Link IE Field Network.

#### ■Periodic communication (cyclic transmission)

Data is periodically communicated among stations within the same network. (☞ Page 58 Cyclic Transmission)

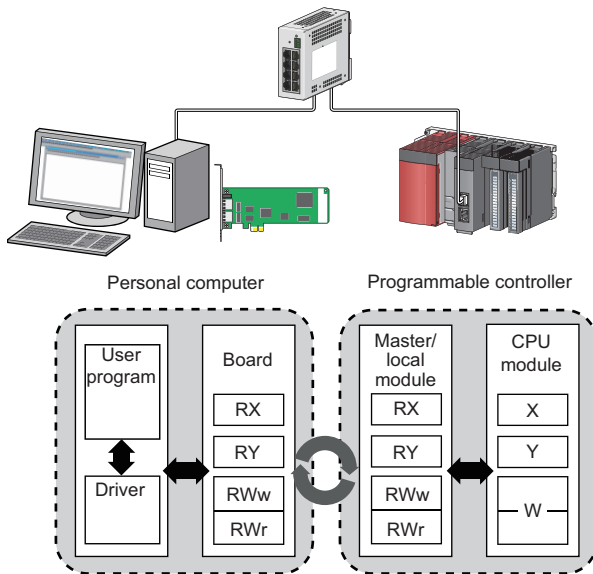

#### ■Non-periodic communication (transient transmission)

Data is communicated upon request. (☞ Page 66 Transient Transmission)

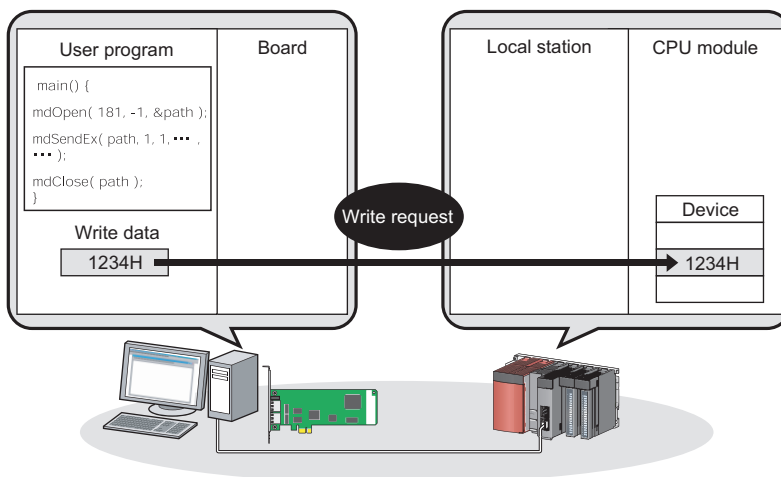

### 1 Gbps communication speed

1 Gbps communication speed allows high-speed communication. Also, the tact time can be reduced due to the improved performance of communication response.

## Use of Ethernet cable

A 1000BASE-T-compliant Ethernet is used for the connection interface. The wiring cost can be reduced because 1000BASE-T-compliant Ethernet cables are commercially available. (☞ Page 29 Cables)

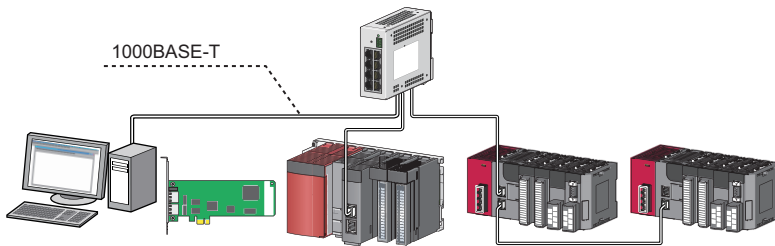

## Flexible wiring for the system arrangements

The network can be wired into star topology, line topology, and ring topology. (☞ Page 20 Network configuration)

For star topology, a 1000BASE-T design switching hub can be used. (☞ Page 29 Hubs)

Wiring is highly flexible because a network can consist of a combination of star and line topologies. For example, the control panels can be connected through a star topology and the production lines through a line topology.

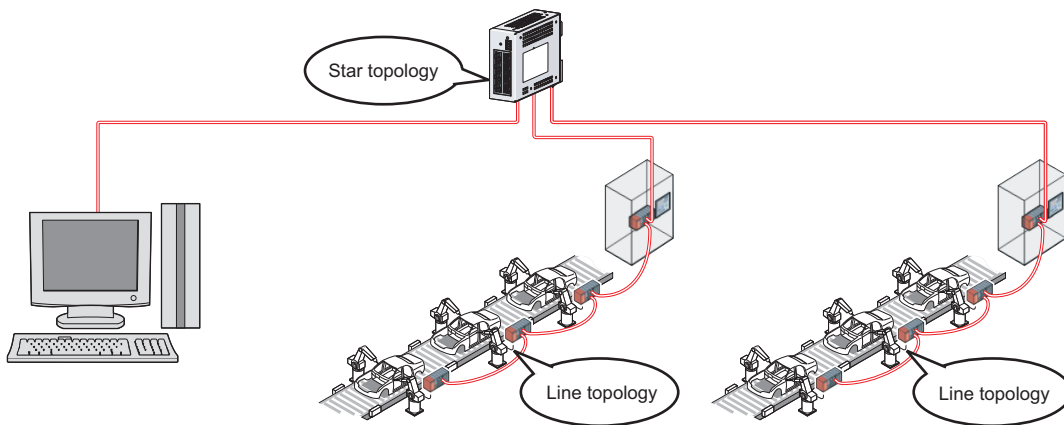

# 1.2 CC-Link IE Field Network Board

CC-Link IE Field Network board allows the connection of a personal computer to CC-Link IE Field Network. CC-Link IE Field Network board can be used as either a master station or local stations of CC-Link IE Field Network.

## A personal computer can be easily connected to CC-Link IE Field Network

A system which contains a personal computer as a master station or local stations of the CC-Link IE Field Network system can be configured.

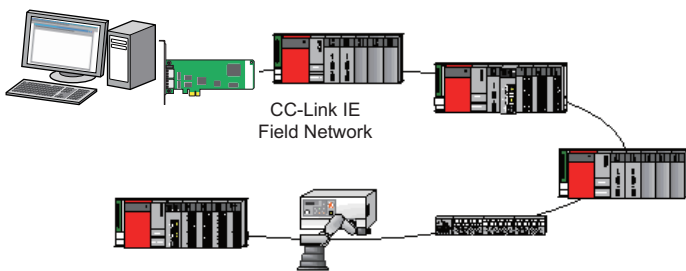

## System controls and high-speed data collection

For a reduction of tact time in a manufacturing system, control data, logging data of manufacturing processes, management data for traceability, and management/diagnostic data for equipment predictive maintenance can be collected at high speed and monitored.

A control system using a programming language such as C language can be configured when a personal computer is used as a master station.

Control data and logging data can be collected at high speed when a personal computer is used as a local station.

A control system using a programming language such as C language can be configured when a personal computer is used as a master station.

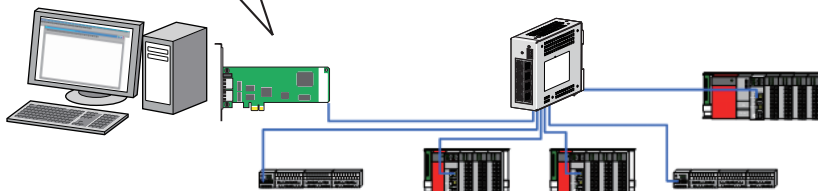

Control data and logging data can be collected at high speed when a personal computer is used as a local station.

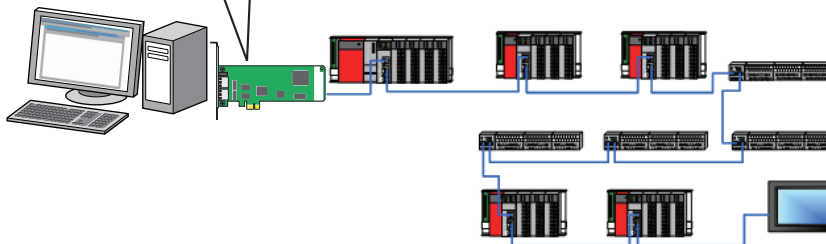

## User programs created using existing boards can be utilized

For user programs to use CC-Link IE Field Network board, the function-level compatibility can be maintained because the common interface (MELSEC data link functions) with the existing boards can be used.

Therefore, user programs created using the existing boards such as CC-Link IE Controller Network board, CC-Link Ver.2 board, MELSECNET/H board, can be utilized for CC-Link IE Field Network board.

Program creation time can be shortened since the users who previously used the existing boards do not need to create a new user program.

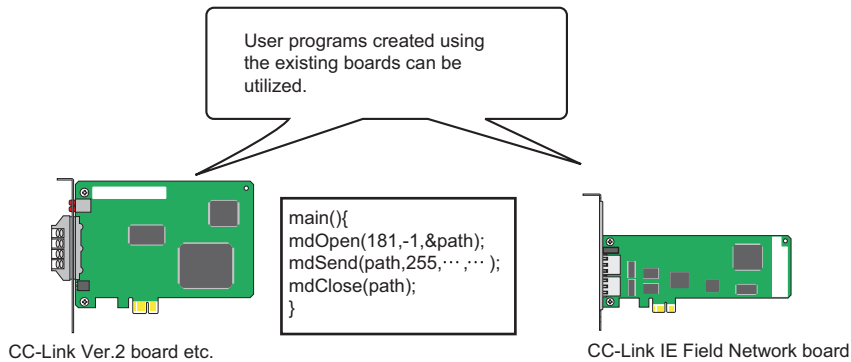

## Checking CC-Link IE Field Network status on the screen

The status of CC-Link IE Field Network can be checked using CC IE Field Utility. Error locations, error causes, and event history are displayed on the screen. This helps to reduce the time for the system to recover from the error.

(☞ Page 125 DIAGNOSING BOARD STATUS)

# 2 SYSTEM CONFIGURATION

## 2.1 System Configuration Using CC-Link IE Field Network Board

A system configuration when using the CC-Link IE Field Network board which is installed to a personal computer is shown below.

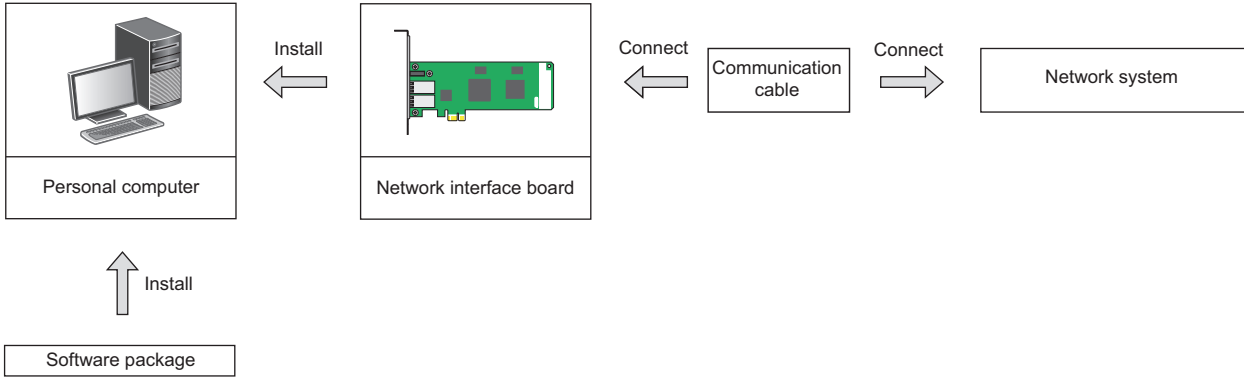

Software package	Network interface board	Communication cable	Network system
SW1DNC-CCIEF-B	Q80BD-J71GF11-T2, Q81BD-J71GF11-T2	Ethernet cable	CC-Link IE Field Network

## 2.2 CC-Link IE Field Network Configuration

This section explains CC-Link IE Field Network configurations.

### Single network system

#### Overall system configuration

Single network system is a system that consists of a master station and device stations connected by Ethernet cables as shown below. Up to 120 device stations and 1 master station can be connected.

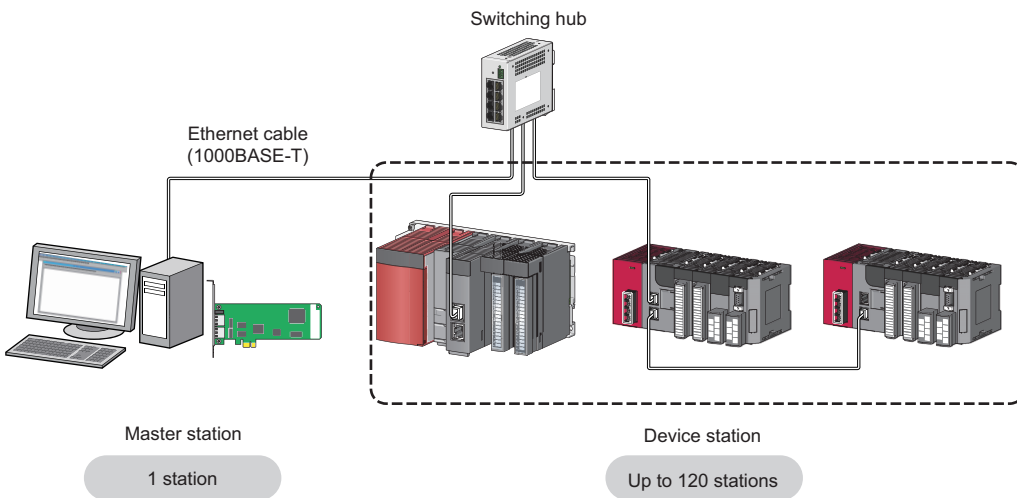

## Network configuration

The network can be wired into star topology, line topology, and ring topology.

A network can consist of a combination of star and line topologies but cannot consist of a combination of ring topology and star or line topology.

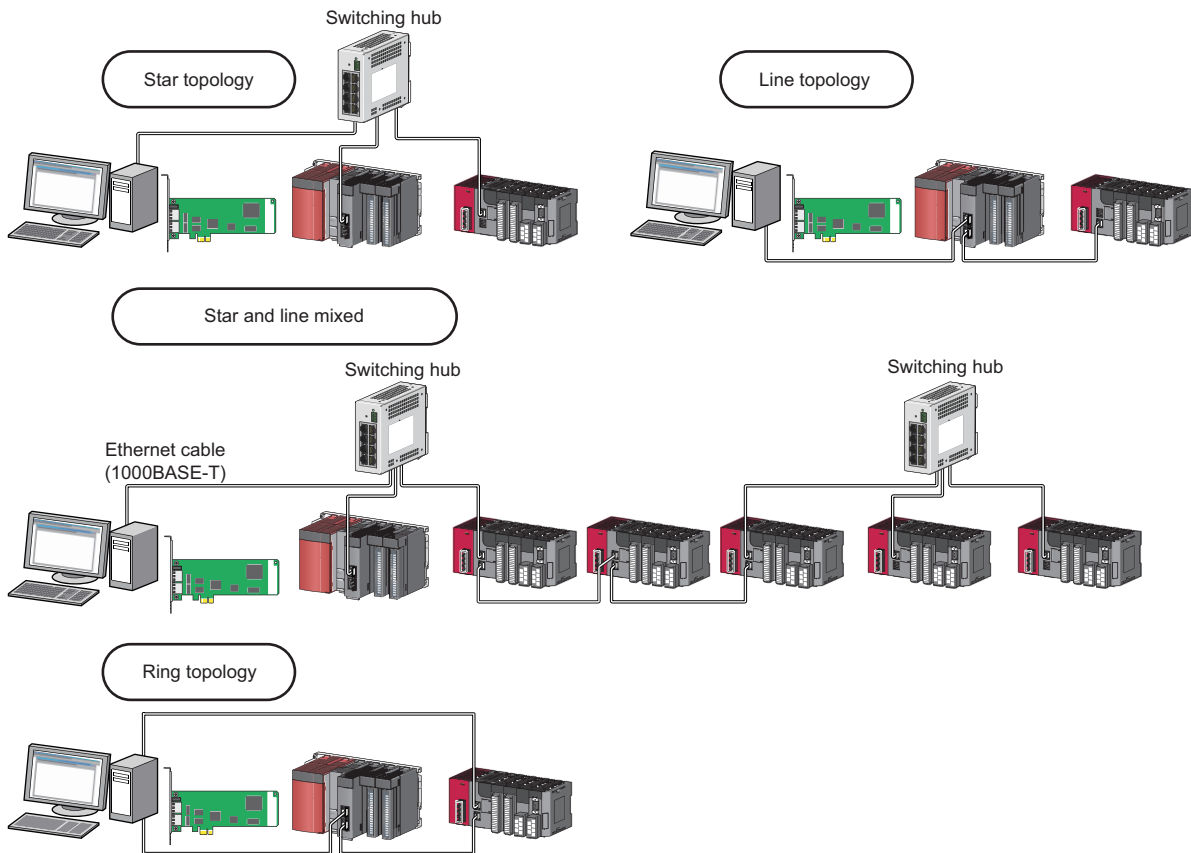

Item	Description
Star topology	The network is formed into a star with a switching hub. Device stations can be easily added by this topology. (Add device stations one by one. If multiple device stations are added at a time, all stations on the network are reconnected. Therefore, an error may momentarily occur in all the stations.)
Line topology	The connection between the board and modules using an Ethernet cable makes a line topology. For line topology, connections are available without using a switching hub.
Ring topology	The connection between the board and modules using an Ethernet cable makes a ring topology. Data link continues with the stations that are operating normally.

Only the device station in which an error has occurred is disconnected from the network. Data link continues with the stations that are operating normally. In a line topology, all stations connected after the faulty station are disconnected. In ring topology, data link continues with the stations that are operating normally.

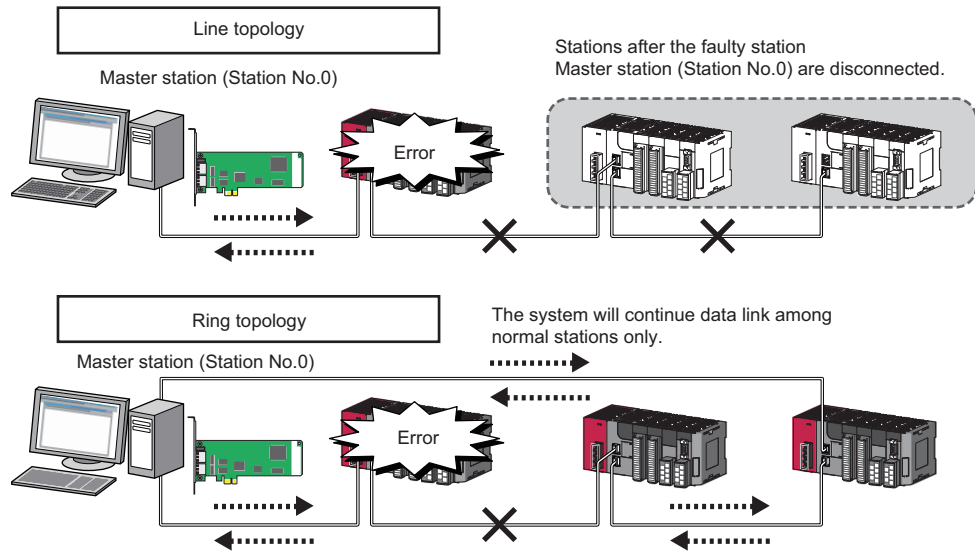

# Multi-network system

The multi-network system is a system in which multiple networks are connected by some relay stations. Up to 239 networks can be connected.

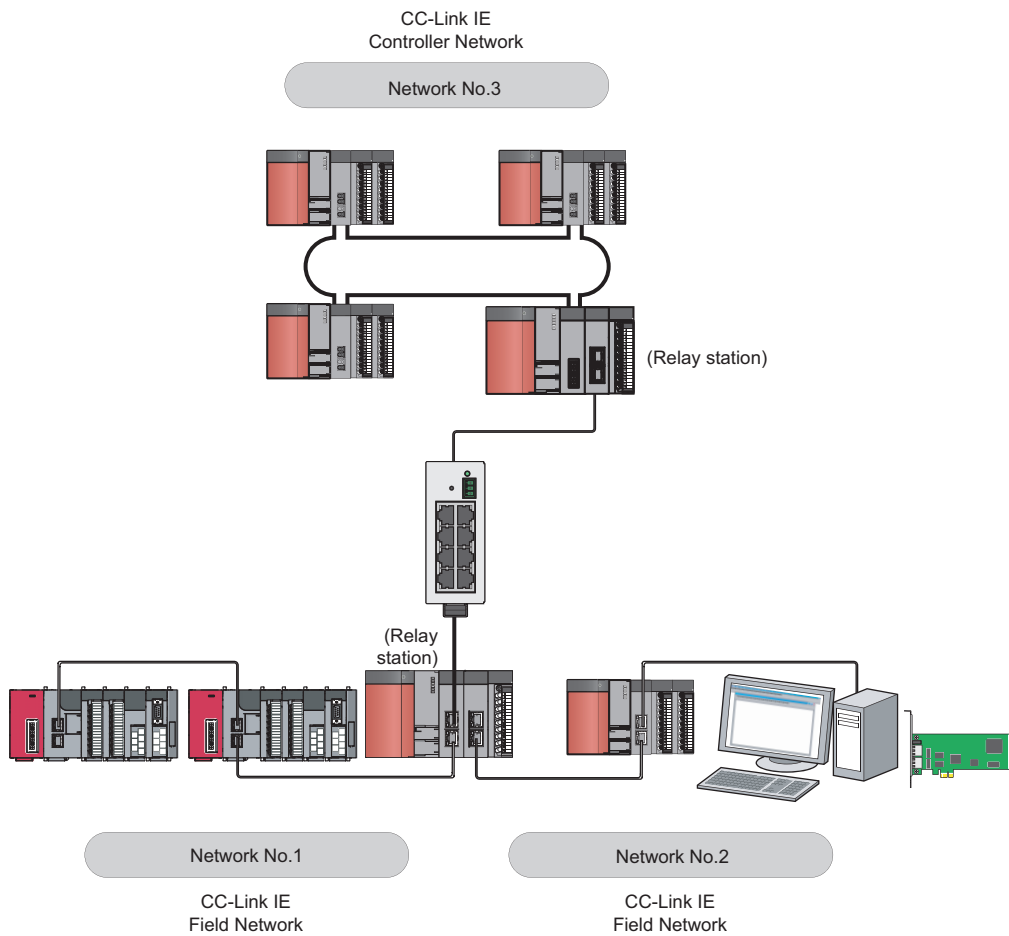

## Point

Cyclic transmission is available only in the same network.

Transient transmission is available with other networks as well as the same network. Communications can be made with stations on up to the eighth network (the number of relay stations: 7). (Page 67 Communication with different networks)

# Precautions

## Adding device stations (including the submaster stations)



If a device station (including a submaster station) is added to a system having 120 device stations (including a submaster station), the system operates as follows.

### ■When a serial number (first five digits) of the master station is '17022' or higher

Baton pass and data link are not performed in the device stations (including the submaster stations) added after the 121st station, and other stations continues baton pass and data link.

Even if the disconnected stations are returned to a system having 121 or more device stations (including a submaster station), the stations may not start data link.

#### Point

- Whether 121 or more device stations (including a submaster station) are connected can be checked using the following:
  - "Selected Station Communication Status Monitor" of CC-Link IE Field diagnostics (  Page 128 Displaying diagnostics screen)
  - Number of connected modules over occurrence status (SB0099)  
Number of connected modules detected by Number of connected modules over occurrence status (SB0099) is the total of the device stations (including a submaster station) which are currently connected and the disconnected stations (device stations which were previously connected).
- The number of stations which were previously connected can be reset by removing the disconnected station of the CC-Link IE Field Network diagnostics. (  Page 128 Displaying diagnostics screen)  
A data link error may momentarily occur in all the stations and output of the connected device stations may turn OFF since all stations on the network will be reconnected when removing the disconnected station. Set it to maintain output data if needed. (  Page 112 Network operation setting)

### ■When a serial number (first five digits) of the master station is '17021' or lower

All stations will fail and data link cannot be performed.

## Connecting devices to the same network

To a switching hub on CC-Link IE Field Network, do not connect an Ethernet device (e.g. personal computer) on a network other than CC-Link IE Field Network. Doing so will cause timeout in the master station, resulting in disconnection among all stations.

## Configuration in which data link cannot be performed (incorrect ring topology)

Do not wire devices as shown below. Doing so will cause an error in all stations and data link cannot be performed.

- Connecting both PORT1 and PORT2 to the switching hub

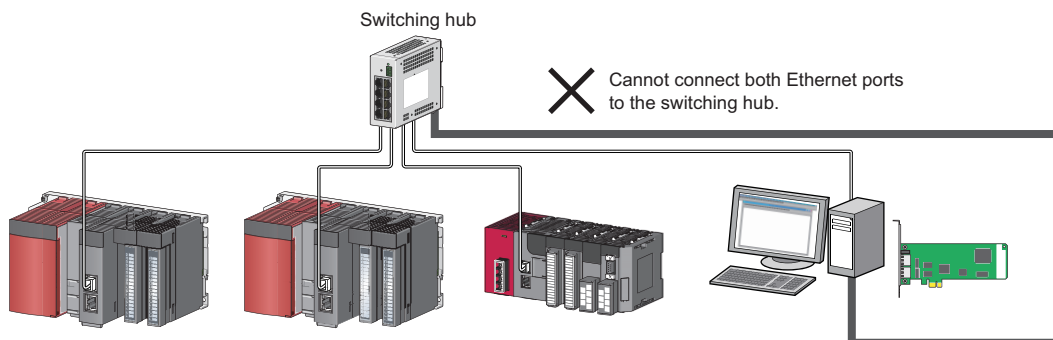

- Ring topology through a switching hub

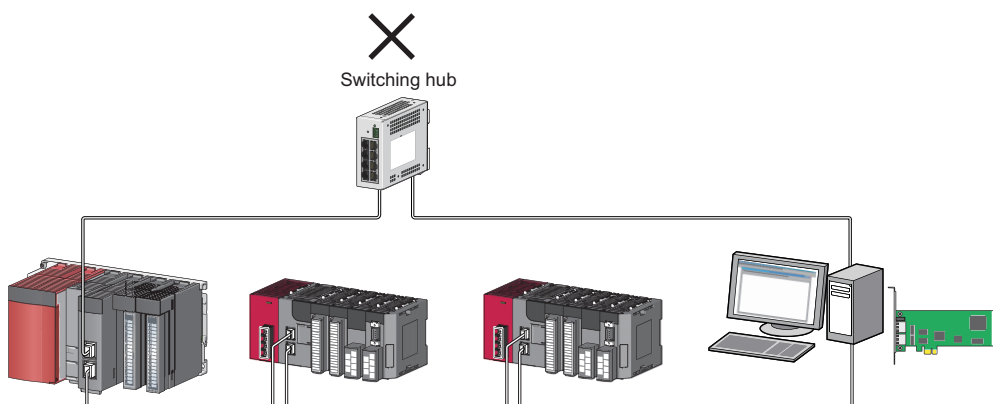

## Ring topology

To configure a network in ring topology, set "Use" for "Loopback Function Setting" in the Network Parameter screen for the master station. (Page 101 Supplementary setting)

When a module is used for the master station, check if the module version supports the loopback function.

MELSEC-Q CC-Link IE Field Network Master/Local Module User's Manual

### ■Configuring a network in ring topology using a switching hub

If a network is configured in ring topology through the two ports of the switching hub, the following problems may arise. Therefore, do not use a switching hub for ring topology.

- Loopback cannot be detected if an Ethernet cable is disconnected.
- If a station is disconnected due to failure or power-OFF, data link will stop.

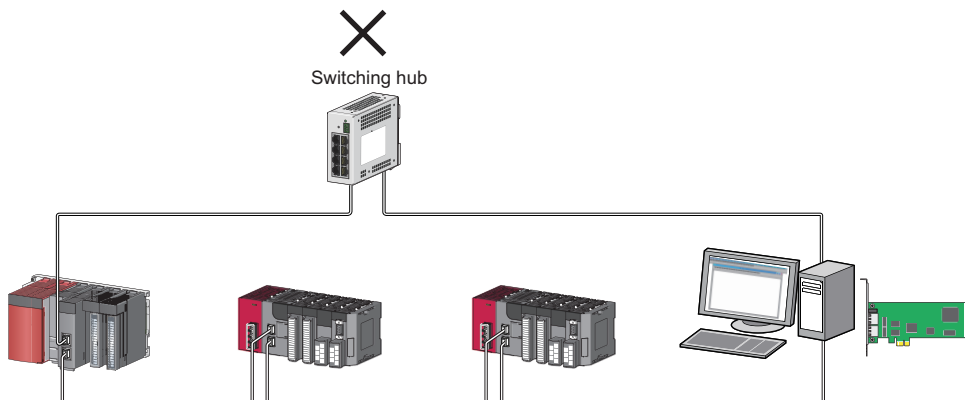

■ **There is an offline mode station on a network configured in ring topology.**

In the following cases, the master station or the station connected to the offline mode station cannot detect loopback.

- Either of the Ethernet cables connected to the offline mode station is disconnected.

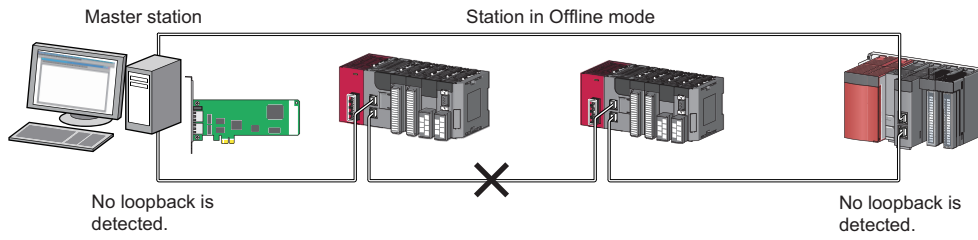

- A station connected to the offline mode station is disconnected.

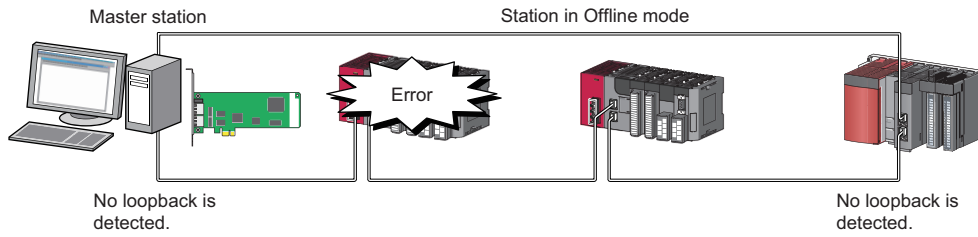

To detect loopback, set the offline mode station as a reserved station.

When the offline mode station is disconnected, loopback can be detected.

## Connecting/disconnecting a cable and turning OFF/ON a device

This section explains the following operations.

Network configuration	Operations
Star topology	<ul style="list-style-type: none"> <li>• Turning OFF/ON a system on a device station or the switching hub</li> <li>• Connecting/disconnecting an Ethernet cable connected to the switching hub</li> <li>• Disconnecting an Ethernet cable from a device station and connecting it to another device station or the switching hub</li> </ul>
Line topology, ring topology	<ul style="list-style-type: none"> <li>• Simultaneously turning OFF/ON systems on multiple stations</li> <li>• Simultaneously connecting/disconnecting Ethernet cables to/from multiple stations (When a data link error station returns, a data link error will occur in all the stations.)</li> </ul>

### ■When a serial number (first five digits) of the master station is '17022' or higher

The actual network configuration and the network map of the CC-Link IE Field Network diagnostics may be a mismatch. Whether mismatch is occurred or not can be checked using 'Network configuration mismatch occurrence status' (SB0098). When using a ring topology, the following may be occurred.

- The station number of the loopback station cannot be detected correctly.
- Even if a switching hub is used, data link does not stop.

#### Point

The actual network configuration and network configuration diagram can be matched by removing the disconnected station of the CC-Link IE Field Network diagnostics. (☞ Page 128 Displaying diagnostics screen)

A data link error may momentarily occur in all the stations and output of the connected device stations may turn OFF since all stations on the network will be reconnected when removing the disconnected station. Set it to maintain output data if needed. (☞ Page 112 Network operation setting)

### ■When a serial number (first five digits) of the master station is '17021' or lower

A data link error may momentarily occur in all the stations and outputs of the connected device stations may turn OFF since all stations on the network will be reconnected.

For a measure to above error, set the "Network Operation Setting" to maintain inputs from data link error station when outputs need to be maintained at an occurrence of a data link error. (☞ Page 112 Network operation setting)

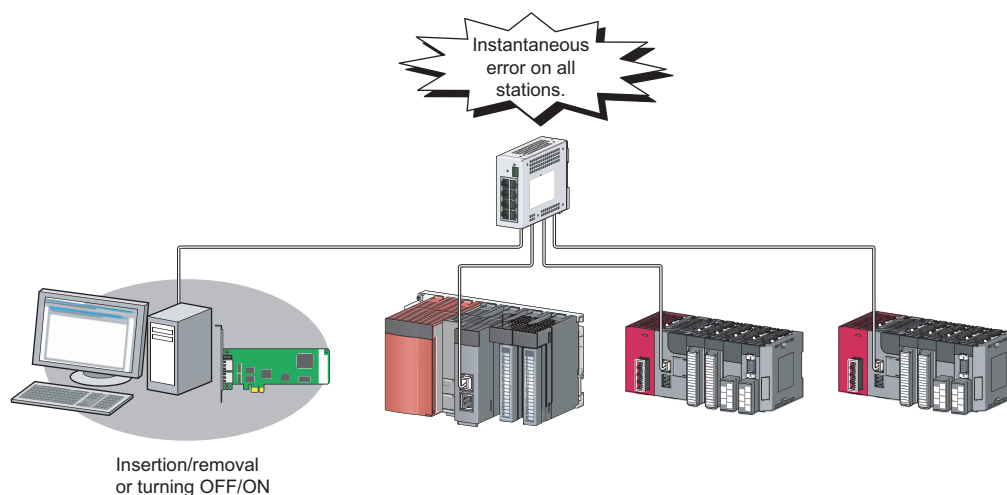

## Data link error in all stations when starting a personal computer

Errors occur in all stations when a personal computer is started.

This is because the line between P1 and P2 of CC-Link IE Field Network board is disconnected under the following conditions.

- The power of the personal computer is turned OFF. (The line becomes in a conduction state when the power is turned ON.)
- A reconnection is in progress when starting a board driver.

As a result, the following reconnection occurs and causes an error in all station.

- A reconnection of CC-Link IE Field Network board installed in a personal computer.
- A reconnection of station which is located beyond the CC-Link IE Field Network board from the point of the master station.

If multiple boards are installed in a single personal computer, this symptom occurs for the same number of times as the number of installed boards.

## Connected station numbers

Connected station numbers should not be duplicated. Data link may be stopped when the station number is duplicated.

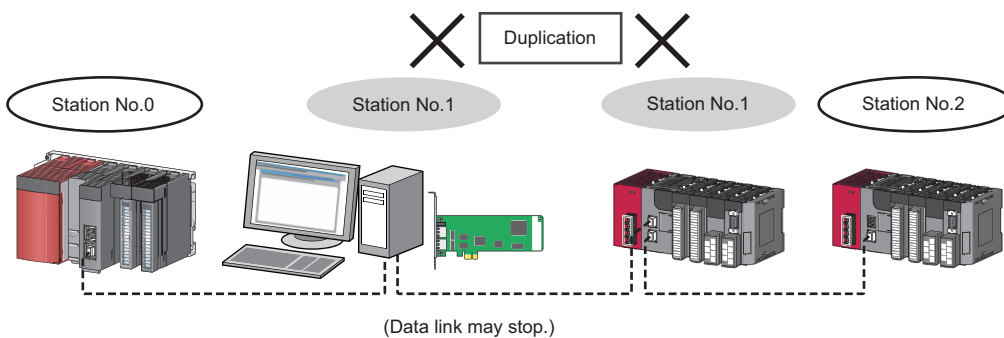

## Turn-ON order

To avoid incorrect input from device stations, turn ON device stations first and then the master station.

## Station replacement

### ■When replacing device stations

Replace them one by one while other stations are not disconnected.

Do not change the connection position.

The station number may be duplicated.

### ■When replacing device stations connected to the same network with each other

Perform either of the following operations before reconnecting them.

- Click the [Update] button in the diagnostics screen of CC-Link IE Field Network. (  Page 128 Displaying diagnostics screen)
- Reset the master station or power OFF and ON.

Failure to do so may cause station number duplication.

## Precautions for when connecting the MELSEC iQ-R series module

Note that the following points when connecting a MELSEC iQ-R series module in the system where a CC-Link IE Field Network board is used as the master station.

### ■Connecting to a local station or remote head module of a MELSEC iQ-R series

When connecting to a local station or remote head module of a MELSEC iQ-R series module, note the following points.

- Use SW1DNC-CCIEF-B Version 1.06G or later.
- Use a CC-Link IE Field Network board with a serial number of which the first five digits are '16012' or higher.
- When using a CC-Link IE Field Network board with a serial number of which the first five digits are '16011' or lower, set the RX/RX setting in "Network Configuration Settings" that will be assigned to the master station with the following corrective actions:

Action	Example																																																																																																						
Set the largest end number in all stations to multiples of 32 - 1 by changing the number of cyclic assignment points or adding the reserved station.	<p>• Before change</p> <table border="1"> <thead> <tr> <th rowspan="2">Number of PLCs</th> <th rowspan="2">Station No.</th> <th rowspan="2">Station Type</th> <th colspan="3">RX/RX Setting</th> </tr> <tr> <th>Points</th> <th>Start</th> <th>End</th> </tr> </thead> <tbody> <tr><td>1</td><td>1</td><td>Local Station</td><td>32</td><td>0000</td><td>001F</td></tr> <tr><td>2</td><td>2</td><td>Remote Device Station</td><td>16</td><td>0020</td><td>002F</td></tr> <tr><td>3</td><td>3</td><td>Remote Device Station</td><td>16</td><td>0030</td><td>003F</td></tr> <tr><td>4</td><td>4</td><td>Remote Device Station</td><td>16</td><td>0040</td><td>004F</td></tr> <tr><td>5</td><td>5</td><td>Remote Device Station</td><td>16</td><td>0050</td><td>005F</td></tr> <tr><td>6</td><td>6</td><td>Remote Device Station</td><td>16</td><td>0060</td><td>006F</td></tr> <tr><td>7</td><td>7</td><td>Local Station</td><td>32</td><td>0070</td><td>008F</td></tr> </tbody> </table> <p>• After change</p> <table border="1"> <thead> <tr> <th rowspan="2">Number of PLCs</th> <th rowspan="2">Station No.</th> <th rowspan="2">Station Type</th> <th colspan="3">RX/RX Setting</th> </tr> <tr> <th>Points</th> <th>Start</th> <th>End</th> </tr> </thead> <tbody> <tr><td>1</td><td>1</td><td>Local Station</td><td>32</td><td>0000</td><td>001F</td></tr> <tr><td>2</td><td>2</td><td>Remote Device Station</td><td>16</td><td>0020</td><td>002F</td></tr> <tr><td>3</td><td>3</td><td>Remote Device Station</td><td>16</td><td>0030</td><td>003F</td></tr> <tr><td>4</td><td>4</td><td>Remote Device Station</td><td>16</td><td>0040</td><td>004F</td></tr> <tr><td>5</td><td>5</td><td>Remote Device Station</td><td>16</td><td>0050</td><td>005F</td></tr> <tr><td>6</td><td>6</td><td>Remote Device Station</td><td>16</td><td>0060</td><td>006F</td></tr> <tr><td>7</td><td>7</td><td>Local Station</td><td>48</td><td>0070</td><td>009F</td></tr> </tbody> </table>	Number of PLCs	Station No.	Station Type	RX/RX Setting			Points	Start	End	1	1	Local Station	32	0000	001F	2	2	Remote Device Station	16	0020	002F	3	3	Remote Device Station	16	0030	003F	4	4	Remote Device Station	16	0040	004F	5	5	Remote Device Station	16	0050	005F	6	6	Remote Device Station	16	0060	006F	7	7	Local Station	32	0070	008F	Number of PLCs	Station No.	Station Type	RX/RX Setting			Points	Start	End	1	1	Local Station	32	0000	001F	2	2	Remote Device Station	16	0020	002F	3	3	Remote Device Station	16	0030	003F	4	4	Remote Device Station	16	0040	004F	5	5	Remote Device Station	16	0050	005F	6	6	Remote Device Station	16	0060	006F	7	7	Local Station	48	0070	009F
Number of PLCs	Station No.				Station Type	RX/RX Setting																																																																																																	
		Points	Start	End																																																																																																			
1	1	Local Station	32	0000	001F																																																																																																		
2	2	Remote Device Station	16	0020	002F																																																																																																		
3	3	Remote Device Station	16	0030	003F																																																																																																		
4	4	Remote Device Station	16	0040	004F																																																																																																		
5	5	Remote Device Station	16	0050	005F																																																																																																		
6	6	Remote Device Station	16	0060	006F																																																																																																		
7	7	Local Station	32	0070	008F																																																																																																		
Number of PLCs	Station No.	Station Type	RX/RX Setting																																																																																																				
			Points	Start	End																																																																																																		
1	1	Local Station	32	0000	001F																																																																																																		
2	2	Remote Device Station	16	0020	002F																																																																																																		
3	3	Remote Device Station	16	0030	003F																																																																																																		
4	4	Remote Device Station	16	0040	004F																																																																																																		
5	5	Remote Device Station	16	0050	005F																																																																																																		
6	6	Remote Device Station	16	0060	006F																																																																																																		
7	7	Local Station	48	0070	009F																																																																																																		
Reduce the largest end number in all stations to 7FH or less.	<p>• Before change</p> <table border="1"> <thead> <tr> <th rowspan="2">Number of PLCs</th> <th rowspan="2">Station No.</th> <th rowspan="2">Station Type</th> <th colspan="3">RX/RX Setting</th> </tr> <tr> <th>Points</th> <th>Start</th> <th>End</th> </tr> </thead> <tbody> <tr><td>1</td><td>1</td><td>Local Station</td><td>32</td><td>0000</td><td>001F</td></tr> <tr><td>2</td><td>2</td><td>Remote Device Station</td><td>16</td><td>0020</td><td>002F</td></tr> <tr><td>3</td><td>3</td><td>Remote Device Station</td><td>16</td><td>0030</td><td>003F</td></tr> <tr><td>4</td><td>4</td><td>Remote Device Station</td><td>16</td><td>0040</td><td>004F</td></tr> <tr><td>5</td><td>5</td><td>Remote Device Station</td><td>16</td><td>0050</td><td>005F</td></tr> <tr><td>6</td><td>6</td><td>Remote Device Station</td><td>16</td><td>0060</td><td>006F</td></tr> <tr><td>7</td><td>7</td><td>Local Station</td><td>32</td><td>0070</td><td>008F</td></tr> </tbody> </table> <p>• After change</p> <table border="1"> <thead> <tr> <th rowspan="2">Number of PLCs</th> <th rowspan="2">Station No.</th> <th rowspan="2">Station Type</th> <th colspan="3">RX/RX Setting</th> </tr> <tr> <th>Points</th> <th>Start</th> <th>End</th> </tr> </thead> <tbody> <tr><td>1</td><td>1</td><td>Local Station</td><td>32</td><td>0000</td><td>001F</td></tr> <tr><td>2</td><td>2</td><td>Remote Device Station</td><td>16</td><td>0020</td><td>002F</td></tr> <tr><td>3</td><td>3</td><td>Remote Device Station</td><td>16</td><td>0030</td><td>003F</td></tr> <tr><td>4</td><td>4</td><td>Remote Device Station</td><td>16</td><td>0040</td><td>004F</td></tr> <tr><td>5</td><td>5</td><td>Remote Device Station</td><td>16</td><td>0050</td><td>005F</td></tr> <tr><td>6</td><td>6</td><td>Remote Device Station</td><td>16</td><td>0060</td><td>006F</td></tr> <tr><td>7</td><td>7</td><td>Local Station</td><td>16</td><td>0070</td><td>007F</td></tr> </tbody> </table>	Number of PLCs	Station No.	Station Type	RX/RX Setting			Points	Start	End	1	1	Local Station	32	0000	001F	2	2	Remote Device Station	16	0020	002F	3	3	Remote Device Station	16	0030	003F	4	4	Remote Device Station	16	0040	004F	5	5	Remote Device Station	16	0050	005F	6	6	Remote Device Station	16	0060	006F	7	7	Local Station	32	0070	008F	Number of PLCs	Station No.	Station Type	RX/RX Setting			Points	Start	End	1	1	Local Station	32	0000	001F	2	2	Remote Device Station	16	0020	002F	3	3	Remote Device Station	16	0030	003F	4	4	Remote Device Station	16	0040	004F	5	5	Remote Device Station	16	0050	005F	6	6	Remote Device Station	16	0060	006F	7	7	Local Station	16	0070	007F
Number of PLCs	Station No.				Station Type	RX/RX Setting																																																																																																	
		Points	Start	End																																																																																																			
1	1	Local Station	32	0000	001F																																																																																																		
2	2	Remote Device Station	16	0020	002F																																																																																																		
3	3	Remote Device Station	16	0030	003F																																																																																																		
4	4	Remote Device Station	16	0040	004F																																																																																																		
5	5	Remote Device Station	16	0050	005F																																																																																																		
6	6	Remote Device Station	16	0060	006F																																																																																																		
7	7	Local Station	32	0070	008F																																																																																																		
Number of PLCs	Station No.	Station Type	RX/RX Setting																																																																																																				
			Points	Start	End																																																																																																		
1	1	Local Station	32	0000	001F																																																																																																		
2	2	Remote Device Station	16	0020	002F																																																																																																		
3	3	Remote Device Station	16	0030	003F																																																																																																		
4	4	Remote Device Station	16	0040	004F																																																																																																		
5	5	Remote Device Station	16	0050	005F																																																																																																		
6	6	Remote Device Station	16	0060	006F																																																																																																		
7	7	Local Station	16	0070	007F																																																																																																		

### ■Connecting to a MELSEC iQ-R series redundant system

When connecting to a MELSEC iQ-R series redundant system including CC-Link IE Field Network, note the following points.

- Use SW1DNC-CCIEF-B Version 1.06G or later.
- Use a CC-Link IE Field Network board with a serial number of which the first five digits are '18042' or higher.
- Access to a MELSEC iQ-R series redundant CPU, in which a MELSEC data link library is used, not available. To access to a MELSEC iQ-R series redundant system, use the supported software (GX Works3).

## 2.3 Network Components

The CC-Link IE Field Network consists of the following.

### Cables

For wiring, use the 1000BASE-T-compliant Ethernet cables.

Ethernet cable	Connector	Standard
Category 5e or more (Double shielded/STP) Straight cable	RJ45 connector	The following conditioning cables: IEEE802.3 (1000BASE-T) ANSI/TIA/EIA-568-B (Category 5e)

#### Point

- For CC-Link IE Field Network wiring, use the recommended wiring components by CC-Link Partner Association.
- Cables for CC-Link IE Controller Network cannot be used for CC-Link IE Field Network.

### Product

For any type of queries related to the cables for CC-Link IE Field Network, please contact your local Mitsubishi Electric sales office or representative.

Also, the connector processing of cable length is available for your preference. Please contact your local Mitsubishi Electric sales office or representative.

Type	Model (manufacturer)
CC-Link IE Field Network cable	SC-E5EW series (Mitsubishi Electric System & Service Co., Ltd.)

#### ■ Cable types

The following cable types are available depending on the operating environment.

- Standard type: Cables for inside the control panel and indoor connection
- L type: Cables for outdoor connection

Also for any type of queries related to the cables and relay adapters of flame retardant or waterproof type, please contact your local Mitsubishi Electric sales office or representative.

### Hubs

Use hubs that meet the conditions listed below. Operation is not guaranteed if the hubs do not meet these conditions.

- Compliance with the IEEE802.3 (1000BASE-T)
- Support of the auto MDI/MDI-X negotiation function
- Support of the auto-negotiation function
- Switching hub (layer 2 switch)<sup>\*1</sup>

\*1 A repeater hub is not available.

### Mitsubishi Electric products

Type	Model name
Industrial switching hub	NZ2EHG-T8 (discontinued product), NZ2EHG-T8N
Industrial Managed Switch	NZ2MHG-T8F2

## 2.4 Operating Environment

The following table shows the operating environment for the CC-Link IE Field Network board and SW1DNC-CCIEF-B.

Item	Description
Personal computer	A personal computer on which Microsoft® Windows® operates
CPU	System requirements of the operating system must be met.
Required memory	
PCI bus specifications	For Q80BD-J71GF11-T2 <ul style="list-style-type: none"> <li>Compliant with PCI standard Rev.2.2 (3.3 VDC/5 VDC, 32-bit bus, Reference clock 33 MHz)</li> </ul>
PCI Express® bus specifications	For Q81BD-J71GF11-T2 <ul style="list-style-type: none"> <li>Compliant with PCI Express standard Rev.1.1 (3.3 VDC, Link width 1 lane, Reference clock 100 MHz)</li> </ul>
Available hard disk capacity	1 GB or more
Monitor	Resolution: 1024 × 768 dots or higher
Operating system (English version)	<ul style="list-style-type: none"> <li>Windows Server® 2022 (Standard)</li> <li>Windows 11(Home, Pro, Enterprise, Education, IoT Enterprise LTSC 2024)</li> <li>Windows Server 2019 (Standard)</li> <li>Windows Server 2016 (Standard)*<sup>1</sup></li> <li>Windows 10 (IoT Enterprise LTSC 2021, IoT Enterprise LTSC 2019*<sup>2</sup>, IoT Enterprise LTSC 2016*<sup>2</sup>)</li> </ul>
Programming language (English version)	Visual Basic® and Visual C++® in the following Microsoft Visual Studio®: Visual Studio 2022, Visual Studio 2019, Visual Studio 2017
.NET Framework* <sup>3</sup>	Environment that supports .NET Framework 4.8 or higher
Runtime library* <sup>4</sup>	Microsoft Visual C++ 2015-2019 Redistributable (x64)

\*1 Apply Windows Updates (KB4132216, KB4091664, KB4465659, and KB4534307). However, if KB4480977 is already applied, there is no need to apply KB4534307.

The above Windows Updates may have been discontinued. If the above Windows Updates have been discontinued, please consult Microsoft Corporation.

\*2 64-bit version only

\*3 If .NET Framework 4.8 is not installed, approximately 500 MB of memory is required in the system drive to install it.

\*4 Installed when installing a software package.

If the runtime libraries are not installed, approximately 50 MB of memory is required in the system drive to install them. Do not uninstall the runtime libraries.

There are restrictions on the supported versions for the following operating systems and programming languages.

Item	Description
Operating system (English version)	When using the following operating system, use SW1DNC-CCIEF-B with the version 1.19V or earlier. <ul style="list-style-type: none"> <li>Windows 10 (Home, Pro, Enterprise, Education)</li> </ul>
	When using any of the following operating systems, use SW1DNC-CCIEF-B with the version 1.18U or earlier. <ul style="list-style-type: none"> <li>Windows 8.1, Windows 8.1 (Pro, Enterprise)</li> <li>Windows Server 2012 R2 (Standard)</li> <li>Windows 8, Windows 8 (Pro, Enterprise)</li> <li>Windows Server 2012 (Standard)</li> <li>Windows 7 (Home Premium, Professional, Ultimate, Enterprise)*<sup>1</sup></li> <li>Windows Server 2008 R2 (Standard, Enterprise)*<sup>1</sup></li> </ul>
	When using any of the following operating systems, use SW1DNC-CCIEF-B with the version 1.09K or earlier. <ul style="list-style-type: none"> <li>Windows Server 2008 (Standard (x86, x64), Enterprise (x86, x64))</li> <li>Windows Vista® (Home Basic, Home Premium, Ultimate, Business, Enterprise) SP2 or later*<sup>2</sup></li> <li>Windows Server 2003 R2 (Standard (x86, x64), Enterprise Edition (x86, x64)) SP2 or later</li> <li>Windows XP® (Professional, Home Edition) SP3 or later*<sup>2</sup></li> </ul>
Programming language (English version)	Visual Basic® and Visual C++® in the following Microsoft Visual Studio®: When using the following programming language, use SW1DNC-CCIEF-B with the version 1.19V or earlier. Visual Studio 2015
	When using any of the following programming languages, use SW1DNC-CCIEF-B with the version 1.18U or earlier. Visual Studio 2013, Visual Studio 2012, Visual Studio 2010, Visual Studio 2008, Visual Studio 2005, Visual Studio .NET 2003

\*1 Apply Service Pack1 and Security Update for Windows (KB3033929). Otherwise, use SW1DNC-CCIEF-B Version 1.09K or earlier.

\*2 32-bit version only

SW1DNC-CCIEF-B with the version 1.19V or earlier is provided continuously.  
Please contact your local Mitsubishi Electric sales office or representative.

## Instructions for personal computer

### ■PCI standard

When a personal computer which is not compliant with the PCI or PCI Express standard is used, troubles caused by failures such as a contact failure or operation error may occur. This board may not operate when a PCI Express slot for graphics is used.

For details on the number of boards that can be installed, installation slots, and occupied slots, refer to the following:

☞ Page 34 Performance Specifications

## Instructions for operating system

### ■Supported version of SW1DNC-CCIEF-B

Operating system	Supported version	
	Q80BD-J71GF11-T2	Q81BD-J71GF11-T2
Windows 11 (IoT Enterprise LTSC 2024)	Not supported	1.19V or later
Windows Server 2022, Windows 11 (Home, Pro, Enterprise, Education), Windows 10 (IoT Enterprise LTSC 2021)	1.19V or later	1.19V or later
Windows Server 2019, Windows Server 2016, Windows 10 (IoT Enterprise LTSC 2019 , IoT Enterprise LTSB 2016)	1.16S or later	1.16S or later
Windows 10 (Home, Pro, Enterprise, Education)	1.10L to 1.19V	1.10L to 1.19V
Windows 8.1, Windows Server 2012 R2	1.06G to 1.18U	1.06G to 1.18U
Windows 8, Windows Server 2012	1.05F to 1.18U	1.04E to 1.18U
Windows 7 (64-bit version), Windows Server 2008 R2		1.02C to 1.18U
Windows 7 (32-bit version)		1.18U or earlier
Windows Server 2008 (64-bit version)	1.05F to 1.09K	1.02C to 1.09K
Windows Server 2008 (32-bit version)		1.09K or earlier
Windows Vista		
Windows Server 2003 R2 (64-bit version)		1.02C to 1.09K
Windows Server 2003 R2 (32-bit version)		1.09K or earlier
Windows XP		

### ■User authority

Log on as a user with the administrator authority.

- Installation and uninstallation are available only for a user with the administrator authority.
- Utilities can be used only by a user with the administrator authority.

### ■.NET Framework 3.5

Installation of the .NET Framework 3.5 is required.

Enable the .NET Framework 3.5 (including .NET 2.0 or 3.0) in "Turn Windows features on or off" on the control panel.

### ■Upgrading and updating an operating system

The following upgrade and update of an operating system are not supported:

- Upgrade
- Major update (version upgrade)

Install SW1DNC-CCIEF-B by following the procedure:

1. Uninstall SW1DNC-CCIEF-B.
2. Upgrade or update the operating system.
3. Install SW1DNC-CCIEF-B with the software version supporting the changed operating system.

## ■The functions cannot be used

When using any of the following functions, this product may not operate properly.

- Application start-up in Windows compatibility mode
- Fast user switching
- Remote desktop
- Power save mode (hibernate, sleep)
- Fast startup
- Language switching function according to options set in 'Regional and Language'
- Touch function
- Virtual environment such as Client Hyper-V
- Server Core Installation
- Tablet mode
- Virtual desktop
- Unified Write Filter
- Text cursor indicator

In the following cases, the screen of this product may not work properly.

- The size of the text and other items in the screen is other than 100% (96 DPI, 9 pt etc.).
- The resolution of the screen is changed in operation.
- The Windows theme is changed in operation.
- The multi-display is set.

Surrogate pair characters are not available.

### Point

- When exiting the operating system, always shut down the computer.
- For the behavior when entering the power save mode, refer to the following:  
(  Page 235 Behavior When Personal Computer Enters Power Save Mode or Fast Startup)

## Instructions for user program

### ■Supported version of SW1DNC-CCIEF-B

User program	Supported version
32-bit version user program*1	All versions
64-bit version user program*2	1.02C or later

\*1 Programs can be created and executed on the 64-bit version operating system.

\*2 Programs can be created on the 32-bit version operating system, however, the programs cannot be executed.

### ■Language environment

- User programs created in the Japanese environment work only in the Japanese environment.
- User programs created in the English environment work only in the English environment.

### ■MELSEC data link library

For precautions when using MELSEC data link library, refer to the following:

 MELSEC Data Link Library Reference Manual

# 3 SPECIFICATIONS

This chapter explains general and performance specifications of CC-Link IE Field Network board.

## 3.1 General Specifications

General specifications of CC-Link IE Field Network board are shown below.

Item	Specification					
Operating ambient temperature	0 to 55°C					
Storage ambient temperature	-25 to 75°C					
Operating ambient humidity	5 to 95% RH, non-condensing					
Storage ambient humidity						
Vibration resistance	—	Frequency	Constant acceleration	Half amplitude	Sweep count	IEC 61131-2: 2007 and JIS B 3502: 2011
	Under intermittent vibration	5 to 8.4 Hz	—	3.5 mm	10 times each in X, Y, and Z directions	
		8.4 to 150 Hz	9.8 m/s <sup>2</sup>	—		
	Under continuous vibration	5 to 8.4 Hz	—	1.75 mm	—	
8.4 to 150 Hz		4.9 m/s <sup>2</sup>	—			
Shock resistance	147 m/s <sup>2</sup> , 3 shocks in each direction per axis, on 3 mutually perpendicular axes (total of 18 shocks)					
Operating atmosphere	No corrosive gases					
Operating altitude* <sup>1</sup>	0 to 2000 m					
Installation location	Inside a control panel					
Overvoltage category* <sup>2</sup>	II or less					
Pollution degree* <sup>3</sup>	2 or less					

\*1 Do not use or store the board under the environment where the atmospheric pressure is higher than the one at the altitude of 0 m. Doing so may cause a malfunction.

\*2 This indicates the section of the power supply to which the equipment is assumed to be connected between the public electrical power distribution network and the machinery within premises.

Category II applies to equipment for which electrical power is supplied from fixed facilities.

The surge voltage withstand level for up to the rated voltage of 300V is 2500V.

\*3 This index indicates the degree to which conductive material is generated in terms of the environment in which the equipment is used.

Pollution degree 2 is when only non-conductive pollution occurs. A temporary conductivity caused by condensing must be expected occasionally.

### Point

The general specifications both CC-Link IE Field Network board and a personal computer must be satisfied after installation.

## 3.2 Performance Specifications

Performance specifications of the CC-Link IE Field Network board are shown below.

Item		Specification	
Maximum link points per network		RX	16384 points, 2 KB
		RY	16384 points, 2 KB
		RWr	8192 points, 16 KB
		RWw	8192 points, 16 KB
Maximum link points per station		Master station	
		RX	16384 points, 2 KB
		RY	16384 points, 2 KB
		RWr	8192 points, 16 KB
		RWw	8192 points, 16 KB
		Local station <sup>*1</sup>	
		RX	2048 points, 256 bytes
		RY	2048 points, 256 bytes
RWr	1024 points, 2048 bytes <sup>*2</sup>		
RWw	1024 points, 2048 bytes <sup>*2</sup>		
Communication speed		1 Gbps	
Connection cable		An Ethernet cable that meets the 1000BASE-T standard: Category 5e or higher (double shielded, STP), straight cable (☞ Page 29 Cables)	
Maximum station-to-station distance		100 m (compliant with ANSI/TIA/EIA-568-B (Category 5e)) (☞ Page 48 Precautions for Ethernet cable)	
Overall cable distance		Line topology: 12000 m (when connected to 1 master station and 120 device stations) Star topology: Depends on the system configuration Ring topology: 12100 m (when connected to 1 master station and 120 device stations)	
Number of cascade connections		Up to 20	
Network topology		Line topology, star topology (coexistence of line topology and star topology is possible.), ring topology	
Number of connectable stations per network		Master station	
		Local station	
Maximum number of networks		239	
Communication method		Token passing method	

\*1 This indicates the point which can be assigned for one station by master station. For local station, the data from other station can be received other than these points.

\*2 For "Online (High-speed mode)", 256 points and 512 bytes. (☞ Page 99 Network type and mode)

Item	Specification	
	Q80BD-J71GF11-T2	Q81BD-J71GF11-T2
Number of boards that can be installed	Up to 4	
Installation slot	PCI slot or PCI-X slot (Half size)	PCI Express <sup>®</sup> x1, x4, x8, x16 slot (Standard/low profile, half size)
Occupied slots	1 slot	1 slot
Internal current consumption	1.10 A (5 VDC)	1.68 A (3.3 VDC)
Weight	0.11 kg	Standard size: 0.08 kg Low profile size: 0.07 kg

## 3.3 Buffer Memory List

The buffer memory is used for exchanging data between the CC-Link IE Field Network board and the master/local module. The content of the buffer memory returns to the default (initial values) when the power is turned OFF or the CC-Link IE Field Network board is reset.

Address (Decimal (Hexadecimal))	Name		Initial value	Read, write	Reference
0 to 1023 (0 to 3FFH)	Link device area	Remote input (RX)	0	Read	☞ Page 192 Link device area
1024 to 2047 (400H to 7FFH)		Remote output (RY)		Read, write	
2048 to 10239 (800H to 27FFH)		Remote register (RWw)			
10240 to 18431 (2800H to 47FFH)		Remote register (RWr)		Read	
18432 to 18463 (4800H to 481FH)		Link special relay (SB)		<ul style="list-style-type: none"> <li>• 18432 to 18433 for read and write</li> <li>• 18434 to 18463 for read only</li> </ul>	
18464 to 18975 (4820H to 4A1FH)		Link special register (SW)		<ul style="list-style-type: none"> <li>• 18464 to 18495 for read and write</li> <li>• 18496 to 18975 for read only</li> </ul>	
18976 to 19455 (4A20H to 4BFFH)	System area				—
19456 (4C00H)	RX offset/size information	Station No.1 RX offset	0	Read	☞ Page 194 RX offset/size information (Address 19456 to 19695 (4C00H to 4CEF))
19457 (4C01H)		Station No.1 RX size			
to		to			
19694 (4CEEH)		Station No.120 RX offset			
19695 (4CEFH)		Station No.120 RX size			
19696 to 19711 (4CF0H to 4CFFH)	System area				—
19712 (4D00H)	RY offset/size information	Station No.1 RY offset	0	Read	☞ Page 194 RY offset/size information (Address 19712 to 19951 (4D00H to 4DEF))
19713 (4D01H)		Station No.1 RY size			
to		to			
19950 (4DEEH)		Station No.120 RY offset			
19951 (4DEFH)		Station No.120 RY size			
19952 to 19967 (4DF0H to 4DFFH)	System area				—
19968 (4E00H)	RWw offset/size information	Station No.1 RWw offset	0	Read	☞ Page 195 RWw offset/ size information (Address 19968 to 20207 (4E00H to 4EEFH))
19969 (4E01H)		Station No.1 RWw size			
to		to			
20206 (4EEEH)		Station No.120 RWw offset			
20207 (4EEFH)		Station No.120 RWw size			
20208 to 20223 (4EF0H to 4EFFH)	System area				—

Address (Decimal (Hexadecimal))	Name		Initial value	Read, write	Reference
20224 (4F00H)	RWr offset/size information	Station No.1 RWr offset	0	Read	Page 195 RWr offset/ size information (Address 20224 to 20463 (4F00H to 4FEFH))
20225 (4F01H)		Station No.1 RWr size			
to		to			
20462 (4FEEH)		Station No.120 RWr offset			
20463 (4FEFH)		Station No.120 RWr size			
20464 to 20511 (4FF0H to 501FH)	System area				—
20512 (5020H)	Own station information (network card information)	Manufacturer code	0	Read	Page 196 Network card information (Address 20512 to 20515 (5020H to 5023H))
20513 (5021H)		Model type			
20514 (5022H)		Model code	1		
20515 (5023H)		Version			
20516 to 20519 (5024H to 5027H)	System area				—
20520 (5028H)	Own station information (controller information)	Controller information valid/invalid flag	0	Read, write	Page 196 Controller information (Address 20520 to 20536 (5028H to 5038H))
20521 (5029H)		Manufacturer code			
20522 (502AH)		Model type			
20523 (502BH)		Model code			
20524 (502CH)		Version			
20525 to 20534 (502DH to 5036H)		Model name string			
20535 to 20536 (5037H to 5038H)		Vendor-specific device information			
20537 to 20538 (5039H to 503AH)	System area				—
20544 (5040H)	Other station information (station No.1) (network card information)	Manufacturer code	0	Read	Page 197 Station number 1 (Address 20544 to 20575 (5040H to 505FH))
20545 (5041H)		Model type			
20546 (5042H)		Model code			
20547 (5043H)		Version			
20548 to 20551 (5044H to 5047H)	System area				—

Address (Decimal (Hexadecimal))	Name	Initial value	Read, write	Reference
20552 (5048H)	Other station information (station No.1) (controller information)	Controller information valid/invalid flag	Read	Page 197 Station number 1 (Address 20544 to 20575 (5040H to 505FH))
20553 (5049H)		Manufacturer code		
20554 (504AH)		Model type		
20555 (504BH)		Model code		
20556 (504CH)		Version		
20557 to 20566 (504DH to 5056H)		Model name string		
20567 to 20568 (5057H to 5058H)		Vendor-specific device information		
20569 to 20575 (5059H to 505FH)		System area		
20576 to 24383 (5060H to 5F3FH)	Other station information (station No.2 to No.120)	Same as other station information (station No.1)	—	
24384 to 32767 (5F40H to 7FFFH)	System area		—	

**Point** 

Do not write data to "System area".  
Doing so may cause malfunction of the system.

# 4 PROCEDURE BEFORE OPERATION

## 4.1 Procedure Before Operation

This section explains the procedure before operating the CC-Link IE Field Network board.

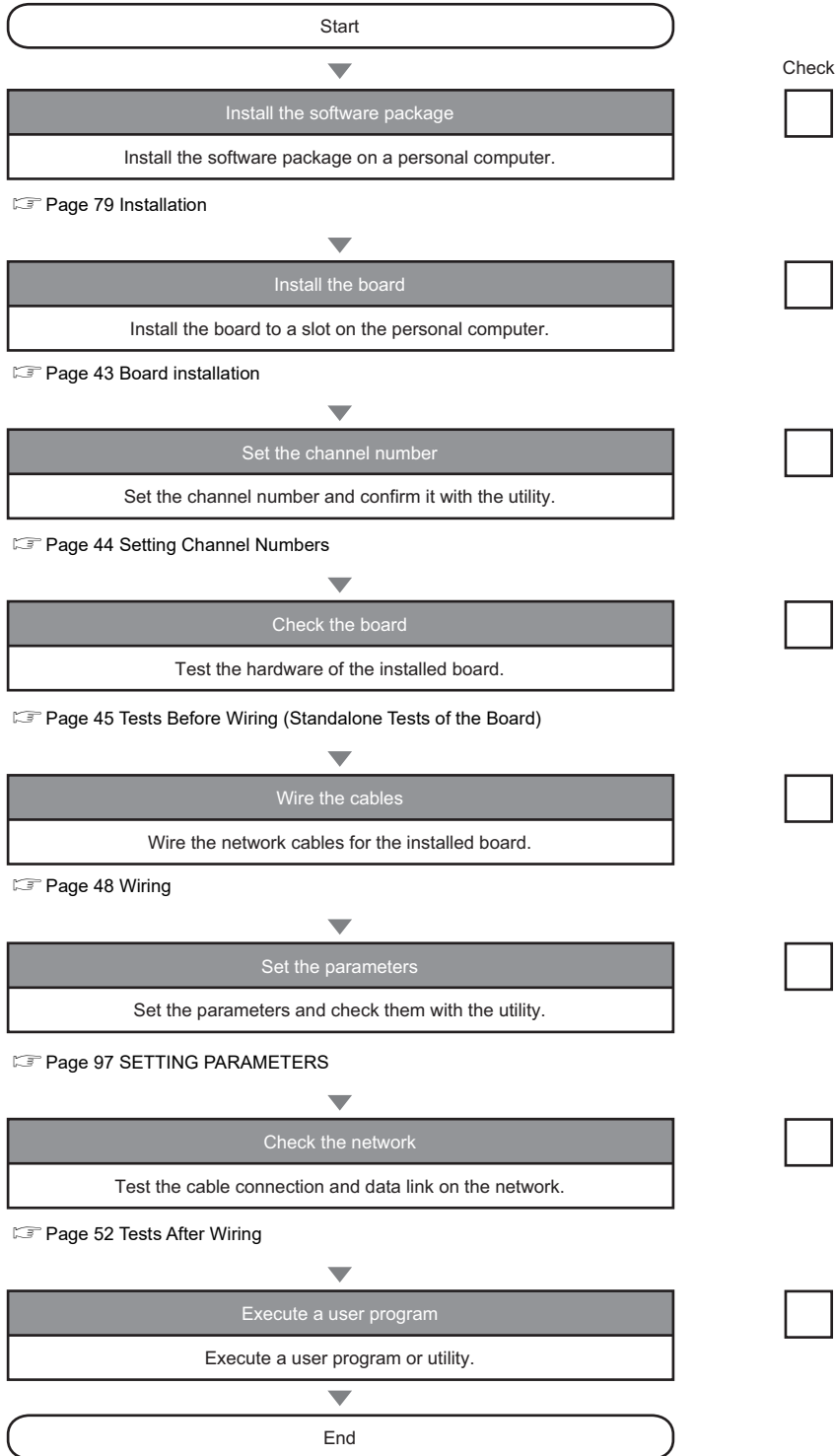

## 4.2 Part Names

This section explains each part name of the CC-Link IE Field Network board.

### Q80BD-J71GF11-T2

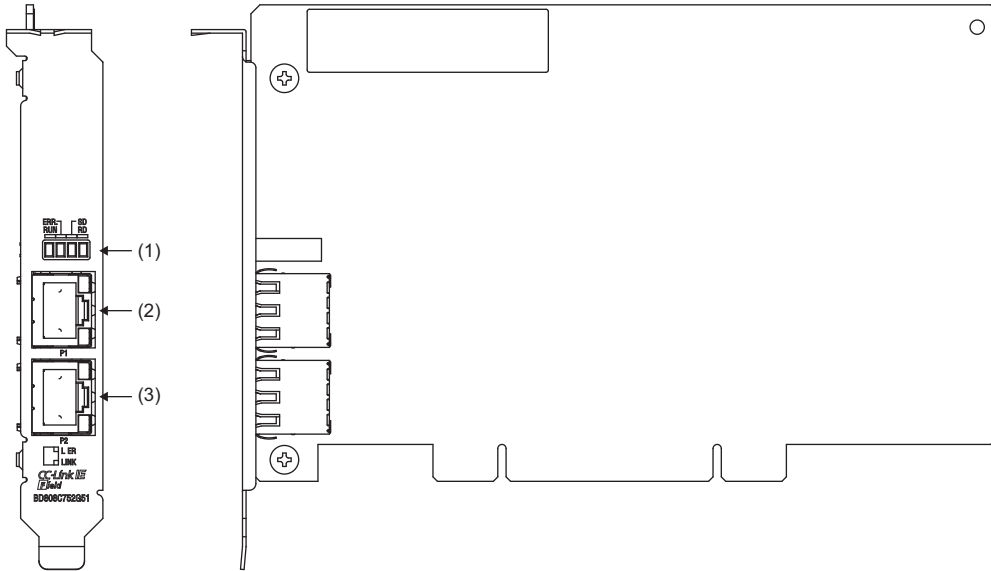

### Q81BD-J71GF11-T2 (standard size)

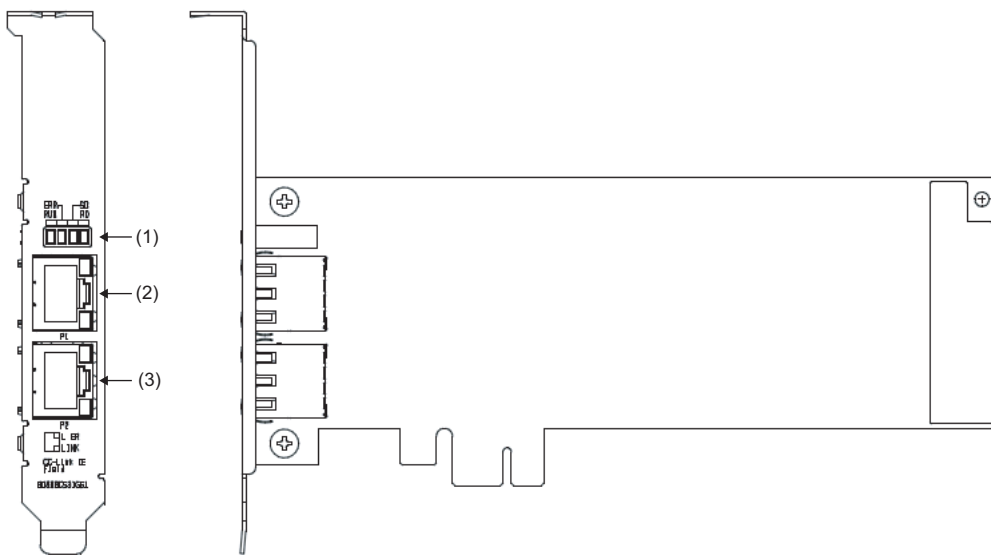

## Q81BD-J71GF11-T2 (low profile size)

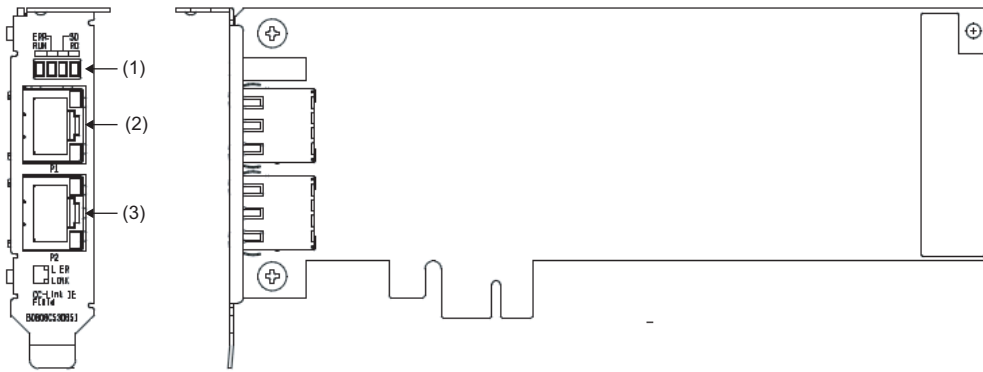

Number	Name	Description	Reference
(1)	Operation LED	Indicates the operating status of the CC-Link IE Field Network board.	Page 40 Operation LED
(2)	P1	PORT1 connector for connecting to CC-Link IE Field Network.	Page 41 Connector
(3)	P2	PORT2 connector for connecting to CC-Link IE Field Network.	

## Operation LED

The operating status of the CC-Link IE Field Network board is displayed.

If an error occurred, refer to the troubleshooting and take a corrective action. (☞ Page 171 Checking LED status)

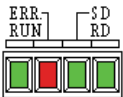

## When the RUN LED is OFF or ON

The same LED display as a network module.

Name	Status	Description
RUN	ON	Operating normally.
	OFF	One of the following error has occurred. <ul style="list-style-type: none"> <li>A hardware failure or a board WDT error has occurred.</li> <li>The driver is not started.</li> </ul>
ERR.	ON	One of the following error has occurred. <ul style="list-style-type: none"> <li>An error is detected in all stations.</li> <li>Stations with same station number exist on the network.</li> <li>Network parameters are corrupted.</li> <li>Network parameters do not match the installation status.</li> </ul> (Reserved station specification, number of connected stations, network number etc.)
	Flashing	A data link error station is detected.
	OFF	Operating normally
SD	ON	Sending data
	OFF	Data not sent
RD	ON	Receiving data
	OFF	Data not received

## When the RUN LED is flashing

An error which is peculiar to boards has occurred.

Name	Status	Description
RUN	Flashing	One of the following error has occurred. (Check ERR.LED, and RD LED.)
ERR.	ON	PCI bus/PCI Express bus error has occurred.
RD	ON	Driver WDT error has occurred.

## When checking channel number

The status is displayed as shown below according to the current channel number while opening the "Channel No. Setting" screen. (☞ Page 120 Setting Board Channel Numbers).



## Connector

The PORT1 and PORT2 connector for CC-Link IE Field Network.

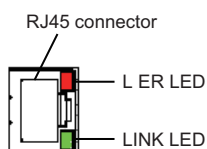

## RJ45 connector

Connect an Ethernet cable. (☞ Page 50 Ethernet cable connection)

## Connector part LED

Display the link status and reception status of the CC-Link IE Field Network board.

Name	Status	Description
L ER	ON	<ul style="list-style-type: none"> <li>The module received abnormal data.</li> <li>The board is performing loopback.</li> </ul>
	OFF	<ul style="list-style-type: none"> <li>The module received normal data.</li> <li>The board does not perform loopback.</li> </ul>
LINK	ON	Linkup in progress.
	OFF	Linkdown in progress.

## 4.3 Installation

---

This section explains precautions for handling and installation environment of the CC-Link IE Field Network board.

### Handling precautions

---

The following explains precautions for handling.

#### Precautions for turning on

---

Do not touch any connectors while power is on. Doing so may cause electric shock or malfunction.

#### Handling precautions of the board

---

- Do not directly touch any conductive parts and electronic components of the board. Doing so can cause malfunction or failure of the board.
- Do not disassemble or modify the boards. Doing so may cause failure, malfunction, injury, or a fire.
- Before handling the board, touch a conducting object such as a grounded metal to discharge the static electricity from the human body. Failure to do so may cause the board to fail or malfunction.
- Handle the board in a place where static electricity will not be generated. Failure to do so may cause a failure or malfunction.
- The board is included in an antistatic envelope. When storing or transporting it, be sure to put it in the antistatic envelope. Failure to do so may cause a failure or malfunction.
- Do not drop or apply a strong impact to the board. Doing so may cause a failure or malfunction.

### Installation environment

---

For installation of the personal computer in which the CC-Link IE Field Network board is installed, refer to the manual for the personal computer.

#### Precautions for board installation environment

---

Use the board in an environment that meets the general specifications in this manual. Failure to do so may result in electric shock, fire, malfunction, or damage to or deterioration of the product.

#### Precautions for personal computer installation environment

---

Always ground the personal computer to the protective ground conductor. Failure to do so may cause a malfunction.

# Procedure for replacing mounting brackets

The following shows the procedure for replacing a standard-size mounting bracket with a low profile-size mounting bracket.

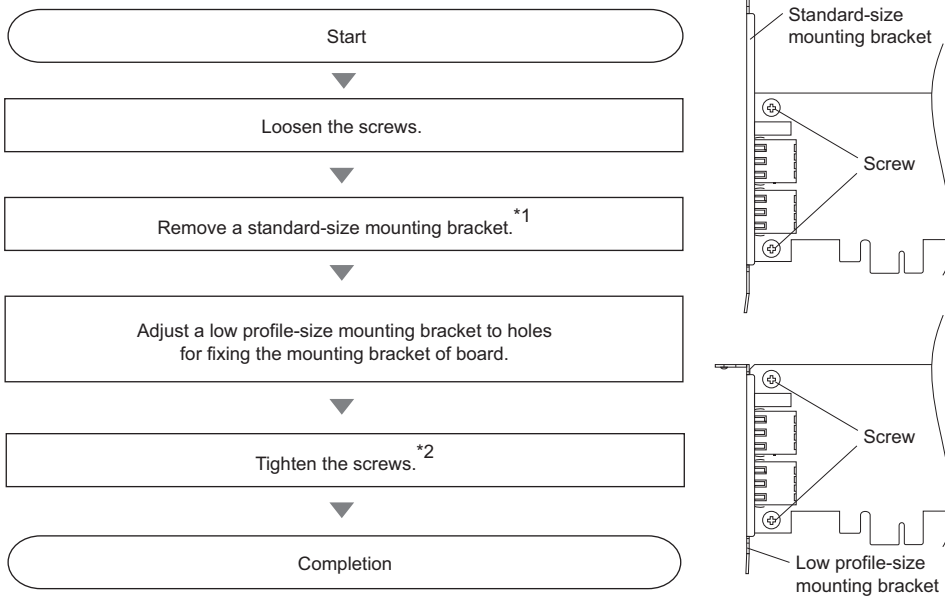

\*1 Keep the unused brackets in secure place.

\*2 Screw tightening torque: 0.425 to 0.575 N·m (4.34 to 5.86 kgf·cm)

# Board installation

The board installation procedure is as follows:

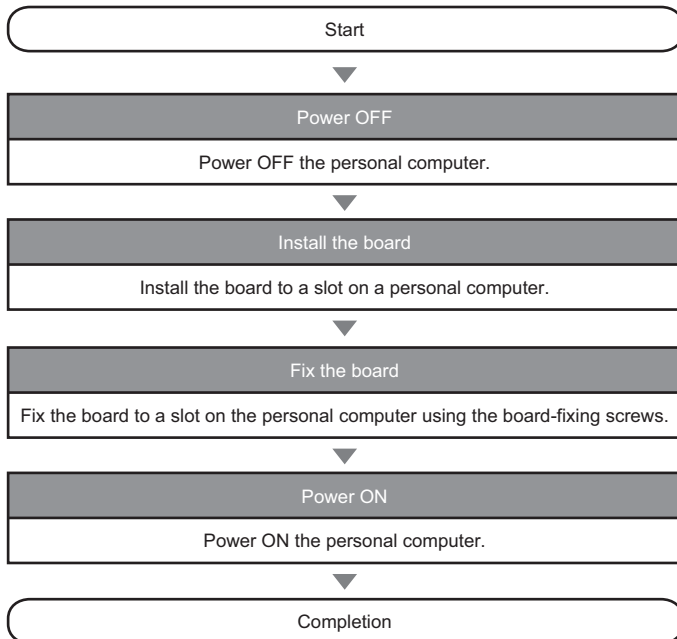

## Precautions for turning on

- Turn off the power for the system in all phases before installing the board to or removing it from the personal computer. Failure to do so may result in electric shock or cause the board to fail or malfunction.

## Precautions for installing the board

- Fix the board by tightening the board-fixing screws within the specified torque range. Undertightening may cause drop, short circuit, or malfunction. Overtightening may damage the screw and/or board, resulting in drop, short circuit, or malfunction. For the tightening torque of the board-fixing screws, refer to the manual supplied with the personal computer.
- Before handling the board, touch a conducting object such as a grounded metal to discharge the static electricity from the human body. Failure to do so may cause the board to fail or malfunction.
- Install the board to a personal computer which is compliant with PCI standard or PCI Express® standard (☞ Page 30 Operating Environment). Failure to do so may cause a failure or malfunction.
- Securely insert the board into the PCI slot following the board installation instruction of the personal computer. Incorrect insertion of the board may cause malfunction, failure, or drop of the board.
- When installing the board, take care not to get injured by an implemented component or a surrounding member.
- When installing the board, take care not to contact with other boards.

# 4.4 Setting Channel Numbers

Channel number is set per board, and used to identify the board. 181 is set for the board channel number as a factory default and the range of 181 to 184 can be set.

Channel numbers being set are used to specify the target boards in setting parameters and performing the MELSEC data link library function. When using two or more boards in a single personal computer, set channel numbers not to overlap.

## Setting method

Set the channel numbers in the "Channel No. Setting" screen in CC IE Field Utility.

(☞ Page 120 Setting Board Channel Numbers)

### Point

Channel numbers set in the "Channel No. Setting" screen is saved in the CC-Link IE Field Network board. The channel numbers being set are retained when performing the following operations.

- Rebooting a personal computer
- Board installation position change
- Board replacement to another personal computer

## 4.5 Tests Before Wiring (Standalone Tests of the Board)

This section explains the CC-Link IE Field Network board tests before network wiring.

### Point

Ethernet cable

Do not connect an Ethernet cable to the CC-Link IE Field Network board in testing a board alone. Doing so may cause the test to fail.

## Bus I/F test

Bus I/F test checks the hardware of the Bus I/F function of the CC-Link IE Field Network board. The following shows a procedure for performing a test.

4

### Operating procedure

Channel No. 181

Mode Bus I/F Test Start Test

• Normal completion

Test Result  
Bus I/F Test was normally completed.

• Abnormal completion

Test Result  
Bus I/F Test was abnormally completed.

1. Select a board to be tested in the "Board Diagnostics" screen in CC IE Field Utility (☞ Page 125 Diagnosing Board).
2. Set Mode to "Bus I/F Test" and click the [Start Test] button.
3. The result is displayed on "Test Result" field.  
If the test is completed abnormally, please contact your local Mitsubishi Electric sales office or representative.

## Memory test

Memory test checks the hardware of the memory function of the CC-Link IE Field Network board. The following shows a procedure for performing a test.

### Operating procedure

Channel No. 181

Mode Memory Test Start Test

1. Select a board to be tested in the "Board Diagnostics" screen in CC IE Field Utility (☞ Page 125 Diagnosing Board).
2. Set Mode to "Memory Test" and click the [Start Test] button.

- Normal completion

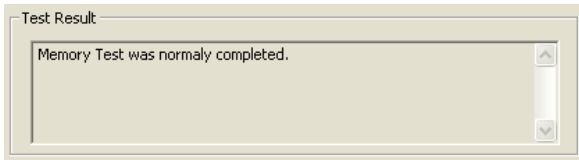

- Abnormal completion

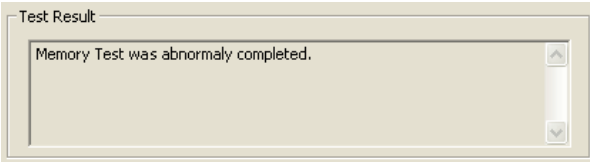

3. The result is displayed on "Test Result" field.  
If the test is completed abnormally, please contact your local Mitsubishi Electric sales office or representative.

## Hardware test

Hardware test checks the hardware in the CC-Link IE Field Network board. The following shows a procedure for performing a test.

### Operating procedure



- Normal completion

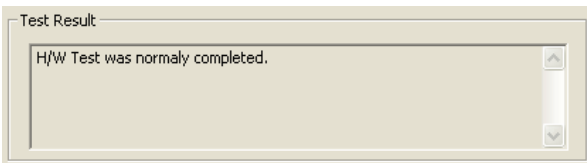

- Abnormal completion

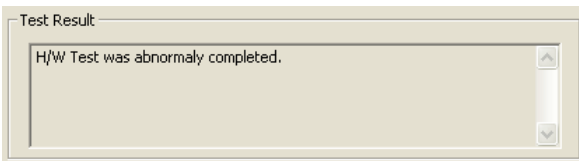

1. Select a board to be tested in the "Board Diagnostics" screen in CC IE Field Utility (Page 125 Diagnosing Board).
2. Set Mode to "H/W Test" and click the [Start Test] button.
3. The result is displayed on "Test Result" field.  
If the test is completed abnormally, please contact your local Mitsubishi Electric sales office or representative.

### Point

#### Operation during hardware test

Do not access the buffer memory in user program during the hardware test. Doing so may cause the test to fail.

# Self-loopback test

Self-loopback test checks the hardware of the CC-Link IE Field Network board alone, including the send/receive circuit of the transmission system and cables. The following shows a procedure for performing a test.

## Operating procedure

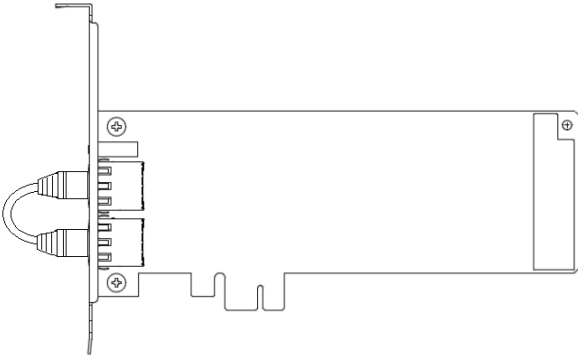

Channel No. 181

Mode Self-Loopback Test Start Test

• Normal completion

Test Result  
Self-Loopback Test was normally completed.

• Abnormal completion

Test Result  
Self-Loopback Test was abnormally completed.

1. Connect Ethernet cables to the RJ45 connector (PORT1) and RJ45 connector (PORT2) of the CC-Link IE Field Network board.

2. Select a board to be tested in the "Board Diagnostics" screen in CC IE Field Utility (☞ Page 125 Diagnosing Board).

3. Set Mode to "Self-Loopback Test" and click the [Start Test] button.

4. The result is displayed on "Test Result" field.

If the test is completed abnormally, replace the Ethernet cable and execute the test again.

If the test is completed abnormally again, please contact your local Mitsubishi Electric sales office or representative.

### Point

When conducting the self-loopback test, use a normal Ethernet cable. (☞ Page 29 Cables)

## 4.6 Wiring

This section explains the cable wiring and precautions. For Ethernet cables and hubs used for the wiring, and network configuration, refer to the system configuration. (☞ Page 19 SYSTEM CONFIGURATION)

### Wiring Precautions

The following explains wiring precautions.

#### Precautions for turning on

- Turn off the power for the system in all phases before installing the board or starting wiring. Failure to do so may result in electric shock, damage to the product, or malfunction.
- After installation of the board and wiring, attach the cover on the module before turning it on for operation. Failure to do so may result in electric shock.

#### Precautions for laying Ethernet cables

- Place the communication cable connected to the board in a duct or clamp them. If not, dangling cables may swing or inadvertently be pulled, resulting in damage to the board or cables or malfunctions due to poor contact.
- Prevent foreign matter such as dust or wire chips from entering the personal computer. Such foreign matter may cause a fire, failure, or malfunction.
- Do not install the communication cables together with the main circuit lines or power cables. Keep a distance of 100mm or more between them. Failure to do so may result in malfunction due to noise.
- Securely plug the communication cable to the connector of the board. Then, check for any incomplete connection. Poor contact may cause an erroneous input or output.
- Do not touch the core of the cable-side or board-side connector, and protect it from dirt or dust. If oil from your hand, dirt or dust is attached to the core, it can increase transmission loss, arising a problem in data link.
- Attach a connector cover to a connector which is not connected to an Ethernet cable to prevent foreign matter such as dirt or dust.

#### Precautions for Ethernet cable

- Check the following:
  - (1) Is any Ethernet cable disconnected?
  - (2) Does any Ethernet cable short?
  - (3) Are the connectors securely connected?
- Do not use Ethernet cables with broken latches. Doing so may cause the cable to unplug or malfunction.
- The maximum station-to-station distance is 100m. However, the distance may be shorter depending on the operating environment of the cable. For details, contact your cable manufacturer.
- The bend radius of the Ethernet cable is limited. For details, see the specifications of the Ethernet cable to be used.

## Precautions for connecting and disconnecting Ethernet cable

- Misalignment of the connecting slot of the personal computer may lead to a slight installation error. When the board-side connector is covered with the personal computer, Ethernet cable cannot be connected properly. Check the board installation status not to overlap the connector and the personal computer.

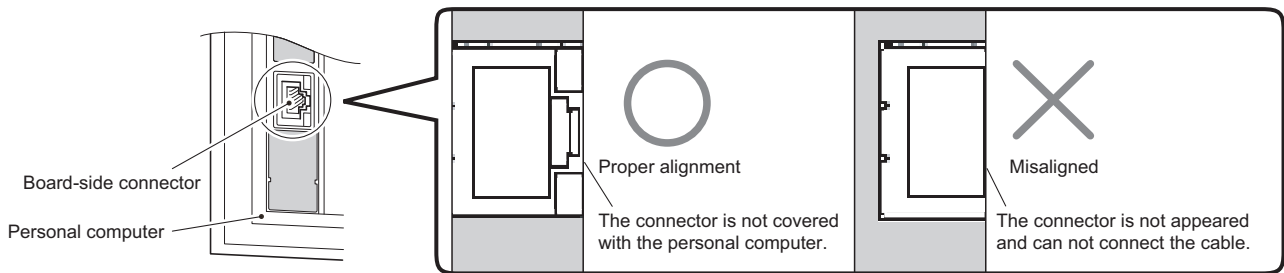

- When disconnecting the cable from the board, do not pull the cable by the cable part. Pulling the cable connected to the board may result in malfunction or damage to the board or cable.
- Depending on the adjacent boards and installing slot position, disconnecting the Ethernet cable may be difficult. In this case, use the following dedicated tool.

Product name	Model name	Maker
Patch cord removal tool	PCRT1	Panduit Corp.

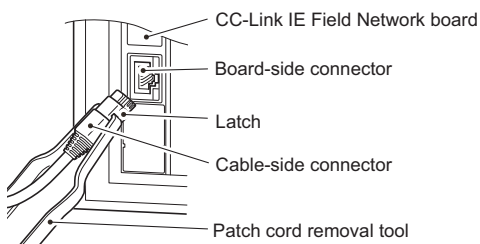

# Ethernet cable connection

The following explains the Ethernet cable connection.

## Connecting the cable

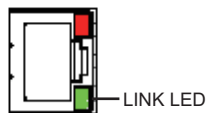
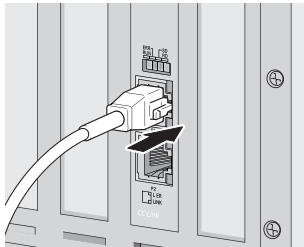

- 1.** Turn off a personal computer on which the CC-Link IE Field Network board is installed, and the connected device.
- 2.** Push the Ethernet cable connector into the CC-Link IE Field Network board and connected device until it clicks. Pay attention to the connector's direction.
- 3.** Turn on the personal computer.
- 4.** Turn on the connected device.
- 5.** Check whether the LINK LED of the CC-Link IE Field Network board connected with an Ethernet cable is ON. The time between the power-ON and the LINK LED turning ON may vary. The LINK LED usually turns ON in a few seconds. Note, however, that the time may be extended further if the linkup process is repeated depending on the status of the device on the line. If the LINK LED does not turn ON, refer to the troubleshooting section and take a corrective action. (☞ Page 150 TROUBLESHOOTING)

PORT1 and PORT2 connectors need not to be distinguished.

- When only one connector is used in star topology, either PORT1 or PORT2 connector can be used.

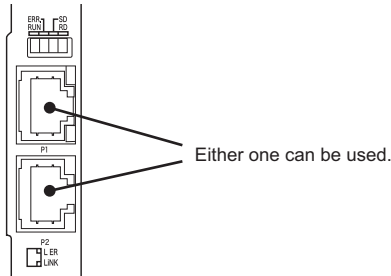

- When using two connectors for line topology and ring topology, an Ethernet cable can be connected to the connectors in any combination. For example, the cable can be connected between PORT1s and between PORT1 and PORT2.

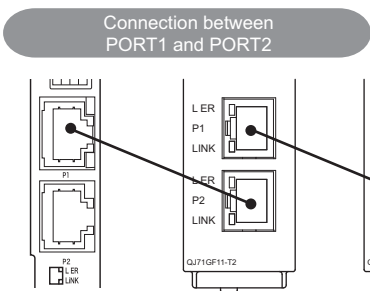
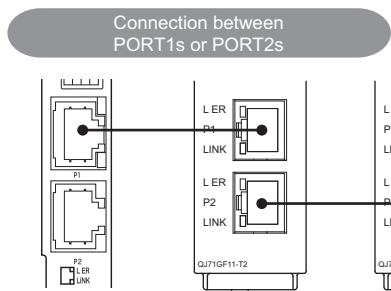

### Disconnecting the cable

1. Power OFF the system.
2. Press the latch down and unplug the Ethernet cable.

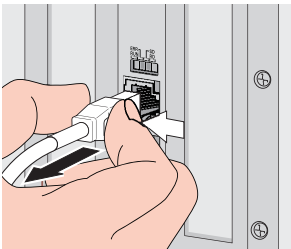

## 4.7 Tests After Wiring

This section explains the tests for a line and cable that should be performed after network wiring. Perform these tests to the actual operating network configuration.

### Loop test

The loop test checks the network cable connection status and line status from master station and the parameter setting status of each station. Confirm whether the network is operating correctly by performing loop test before data link.

The test allows checking the following items.

Item	Description
Master station duplication check	Check if master stations on the network are duplicated.
Station number duplication check	Check if stations on the network are duplicated.
Out-of-range station No. check	Check if device stations exceeding the number of device stations set for the master station are connected.
Reserved station specification check	Check if specified reserved stations are actually connected.
Consistency check of the number of connected stations	Consistency check for the number of total linked stations set by parameters and actual connected device stations.
Station type check	Consistency check for the station type of device stations set in master stations and actual connected station type.
Loopback check	Detect if loopback is being performed while "Use" is set for "Loopback Function Setting" in the Network Parameter of the master station.

### Executing loop tests

The following explains a procedure for loop test, assuming the executing station (master station) is the CC-Link IE Field Network board and the target station (local station) as the CC-Link IE Field Network module.

#### Point

The loop test can be executed only when the CC-Link IE Field Network board is the master station.

When it is the local station, execute the test from the master station in the network system to which the local station is connected.

### ■Preparing loop tests

Prepare the following before loop test.

#### Operating procedure

#### 1. Check for the power discontinuity

Turn OFF the personal computer.

Turn OFF the module.

#### 2. Cable connection

Connect Ethernet cables to each station.

#### 3. Turn-ON

Turn ON the personal computer.

Turn ON the module.

### ■Executing loop tests

The executing station (master station) performs a loop test.

#### Operating procedure

1. Select a board to be tested in the "Board Diagnostics" screen in CC IE Field Utility (Page 125 Diagnosing Board).

Mode

- Normal completion

Test Result

Loop Test was normally completed.

- Abnormal completion

Test Result

Loop Test was abnormally completed.

2. Set Mode to "Loop Test" and click the [Start Test] button.

3. The result is displayed on "Test Result" field.

If the test is completed abnormally, check the error cause in the "CC IE Field Diagnostics" screen, process the error.

( Page 127 Diagnosing CC-Link IE Field Network)

### Point

- During the loop test, data link stops on all stations.
  - When a faulty station cannot be displayed in the "CC IE Field Diagnostics" screen, the following errors may have occurred:
    - Master station duplication
    - Station number duplication
    - Device station type error
- When the faulty station is a module, identify the error causes in the System Monitor screen in GX Works2.
- When the faulty station is a board, identify the error causes in the "Board Diagnostics" screen.
- ( Page 125 Diagnosing Board)

## Cable test

Cable test checks if the Ethernet cables are properly connected.

Only an Ethernet cable connected to the PORT1 or PORT2 of the target station is tested. For the whole network status, check the loop test. ( Page 52 Loop test)

### Operating procedure

1. Start Utility on the computer where CC-Link IE Field Network board is installed.

2. The "Cable test" screen is displayed.

[Diagnostics] ⇒ [CC IE Field Diagnostics] ⇒ [Cable Test] button

3. Enter a station number to conduct a cable test and click the [Execute Test] button so that the test can be operated. When an error occurs, take actions according to the error message.

# Communication test

Communication test checks if transient transmission data can be properly routed from the own station to the communication target.

Take the following system configuration as an example of communication test procedure.

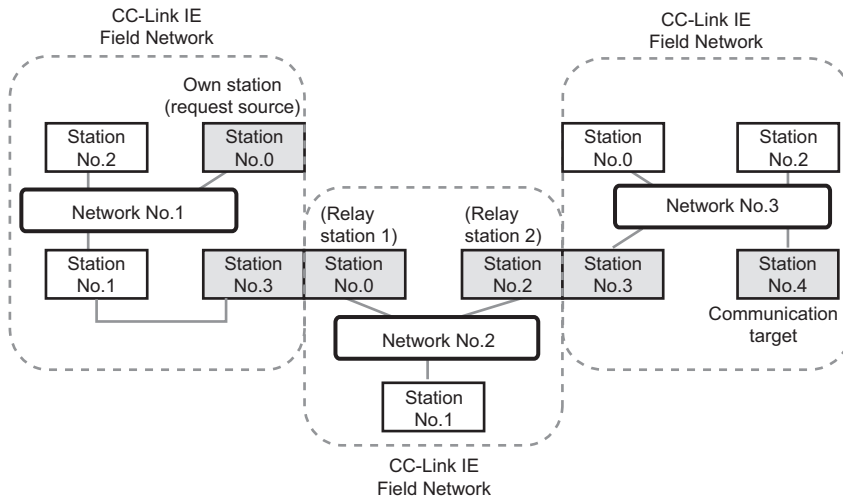

## Operating procedure

Routing parameters for stations of network No.1

	Target Network No.	Relay Network No.	Relay Station No.
1	2	1	3
2	3	1	3

No setting is required for station No.3 because data are transmitted via the station itself.

Routing parameters for stations of network No.2

	Target Network No.	Relay Network No.	Relay Station No.
1	1	2	0
2	3	2	2

No setting is required for station No.0 because data are transmitted via the station itself.  
No setting is required for station No.2 because data are transmitted via the station itself.

Routing parameters for stations of network No.3

	Target Network No.	Relay Network No.	Relay Station No.
1	1	3	3
2	2	3	3

No setting is required for station No.3 because data are transmitted via the station itself.

1. Start Utility on the computer where CC-Link IE Field Network board is installed.
2. Set the routing parameters in the "Routing Parameter Setting" screen as shown on the left.

(☞ Page 116 Routing parameters)

3. Write the network parameters being set to the CC-Link IE Field Network board.

☞ [Online] ⇔ [Write to Board]

4. Reset the board.

☞ [Online] ⇔ [Reset operation]

5. Open the "Communication Test" screen and set data to "Communication Destination Setting" and "Communication Data Setting".

☞ [Diagnostics] ⇔ [CC IE Field Diagnostics] ⇔ [Communication Test] button

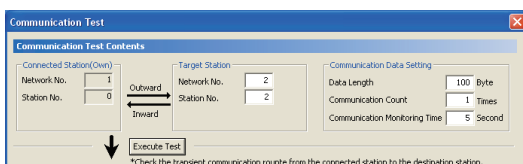

- Click the [Execute Test] button to perform the communication test. If an error occurs, take actions according to the error message.

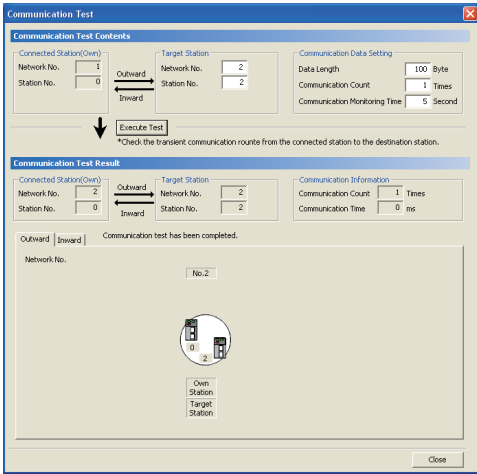

**Point**

When conducting the test on relay stations, set the receiving (relay) station in "Communication Destination Setting". Setting the sending (relay) station will cause an error.

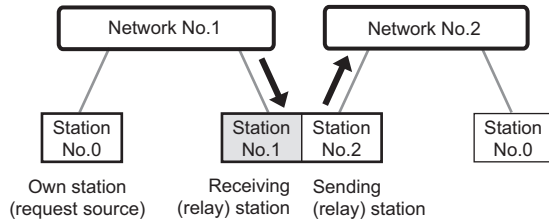

# 5 FUNCTIONS

This chapter explains the functions of the CC-Link IE Field Network board.

## 5.1 Function List

The following table explains the function list of the CC-Link IE Field Network board.

Cyclic transmission			
Function	Description	Reference	
Communication with other stations	Communication by RX and RY	I/O data in bit units is communicated between the own station and other stations.	<ul style="list-style-type: none"> <li>• Page 58 Cyclic Transmission</li> <li>• Page 100 Network configuration setting</li> </ul>
	Communication by RWr and RWr	I/O data in word units is communicated between the own station and other stations.	
Link refresh	Transfer between the link device of the CC-Link IE Field Network board and the device of the driver is performed automatically.	<ul style="list-style-type: none"> <li>• Page 61 Link scan and link refresh</li> <li>• Page 114 Driver setting</li> </ul>	
Mode selection for cyclic transmission	This mode is selected for optimizing the performance of cyclic transmission based on the cyclic transmission and transient transmission frequency. The mode can be selected from "Online (Normal mode)" and "Online (High-speed mode)".	<ul style="list-style-type: none"> <li>• Page 99 Network type and mode</li> <li>• Page 228 Differences in Cyclic Transmission Modes</li> </ul>	
Link scan mode setting	Constant link scan setting can be selected to execute the link scan at a constant time interval.	Page 101 Supplementary setting	
Assurance of cyclic data integrity	The cyclic data integrity is assured in units of 32 bits or station-based units.	<ul style="list-style-type: none"> <li>• Page 62 Assurance of cyclic data integrity</li> <li>• Page 101 Supplementary setting</li> </ul>	
Input status setting for data link faulty station	Select whether the input data from another station where the data link error occurred is cleared or held.	<ul style="list-style-type: none"> <li>• Page 64 Input status of data link faulty station setting</li> <li>• Page 112 Network operation setting</li> </ul>	
Cyclic transmission stop and restart	During debugging and other operations, cyclic transmission is stopped (Data reception from the device station and data transmission from own stations are stopped). Also, the stopped cyclic transmission is restarted. Transient transmission is not stopped.	<ul style="list-style-type: none"> <li>• Page 65 Cyclic transmission stop and restart</li> <li>• Page 140 Link start/stop</li> </ul>	

Transient transmission		
Function	Description	Reference
Communication by MELSEC data link library function	Communicate with other station's programmable controller by MELSEC data link library function. <ul style="list-style-type: none"> <li>• Device reading and writing of other station's programmable controller</li> <li>• Remote operation to other station's programmable controller</li> <li>• Data reading and writing of an intelligent device station</li> </ul>	<ul style="list-style-type: none"> <li>• Page 66 Communication on the same network</li> <li>• Page 68 SEND/RECV Function</li> <li>• Page 146 MELSEC DATA LINK LIBRARY</li> </ul>
Seamless transmission with different networks	Setting the routing parameters beforehand also enables transient transmission to stations in different networks. Communication is also possible with the CC-Link IE Controller Network, and MELSECNET/H.	<ul style="list-style-type: none"> <li>• Page 67 Communication with different networks</li> <li>• Page 116 Routing parameters</li> </ul>

## RAS function

Function	Description	Reference
Device station disconnection	Only the stations where an error has occurred, including device stations, are disconnected from the network, and the data link is continued only with the stations operating normally. In a line topology system, stations after the station where the error occurred are disconnected.	—
Automatic return	When a station disconnected from a network due to a data link error recovers from the error, the station is automatically reconnected to the network and restarts data link.	—
Loopback function	This function disconnects only faulty stations, and continues data link with only normal stations. It also continues data link with normal stations connected after the faulty station which is disconnected in a line topology.	Page 76 Loopback Function

## Diagnostic function

Function	Description	Reference	
CC-Link IE Field Network diagnostics	The status of the CC-Link IE Field Network can be checked by CC IE Field Utility. The faulty area, cause of the fault and its corrective action, and event history can be checked.	Page 127 Diagnosing CC-Link IE Field Network	
Individual board diagnostics	Bus I/F test	Check the hardware related to the bus I/F function of the CC-Link IE Field Network board.	Page 45 Bus I/F test
	Memory test	Check the memory of the CC-Link IE Field Network board.	Page 45 Memory test
	Hardware test	Check the hardware in the CC-Link IE Field Network board.	Page 46 Hardware test
	Self-loopback test	Check the communication circuit of the transmission system of the CC-Link IE Field Network board.	Page 47 Self-loopback test
Own network diagnostics	Loop test	Check the network circuit status and parameter setting status of each station.	Page 52 Loop test
	Cable test	Check the connection status of the Ethernet cable.	Page 53 Cable test
Other network diagnostics	Communication test	Check whether the communication path for transient transmission from the own station to the target station is correct.	Page 54 Communication test

## Other functions

Function	Description	Reference
Reserved station specification	The reserved stations are included in the number of stations that will be connected to the network in the future without actually connecting them. Reserved stations are not detected as faulty stations even though they are not actually connected.	<ul style="list-style-type: none"> <li>• Page 73 Reserved Station Specification and Reserved Station Function Disable Function</li> <li>• Page 100 Network configuration setting</li> <li>• Page 143 Reserved station function enable</li> </ul>
Reserved station function disable	Reserved stations can be temporarily disabled without changing parameters.	
Error invalid station and temporary error invalid station setting	The master station does not detect a device station as a faulty station even if the device station is disconnected during data link. This can be used when a device station is replaced during data link, for instance.	<ul style="list-style-type: none"> <li>• Page 74 Error Invalid Station and Temporary Error Invalid Station Setting Function</li> <li>• Page 100 Network configuration setting</li> <li>• Page 144 Enable/Disable ignore station errors</li> </ul>
Event notification to program	Event conditions are checked every link scan, and if the event conditions are met, notifies events to the user program.	<ul style="list-style-type: none"> <li>• Page 75 Event Function</li> <li>• Page 112 Event setting</li> </ul>
Driver WDT function	This function monitors the operation of the software (operating system, driver) inside the hardware.	Page 77 Driver WDT function
Parameter setting function for CC-Link IE Field Network remote device station	The parameters of CC-Link IE Field Network remote device station can be set by using mdRemBufWriteEx function or mdRemBufReadEx function of MELSEC data link library.	 MELSEC Data Link Library Reference Manual

## 5.2 Cyclic Transmission

This function performs periodical data communication across same network stations during cyclic transmission. For data communication, link devices (RX, RY, RWw, and RWr) are used.

### Data flow and link device assignment

#### Master station and device stations (except for local stations)

A 1:1 communication can be established between the master station and device stations.

The status information of the link devices (RY, RWw) of the master station is output to the external device of the device station, and the input status information from the external device of the device station is stored in the link devices (RX, RWr) of the master station.

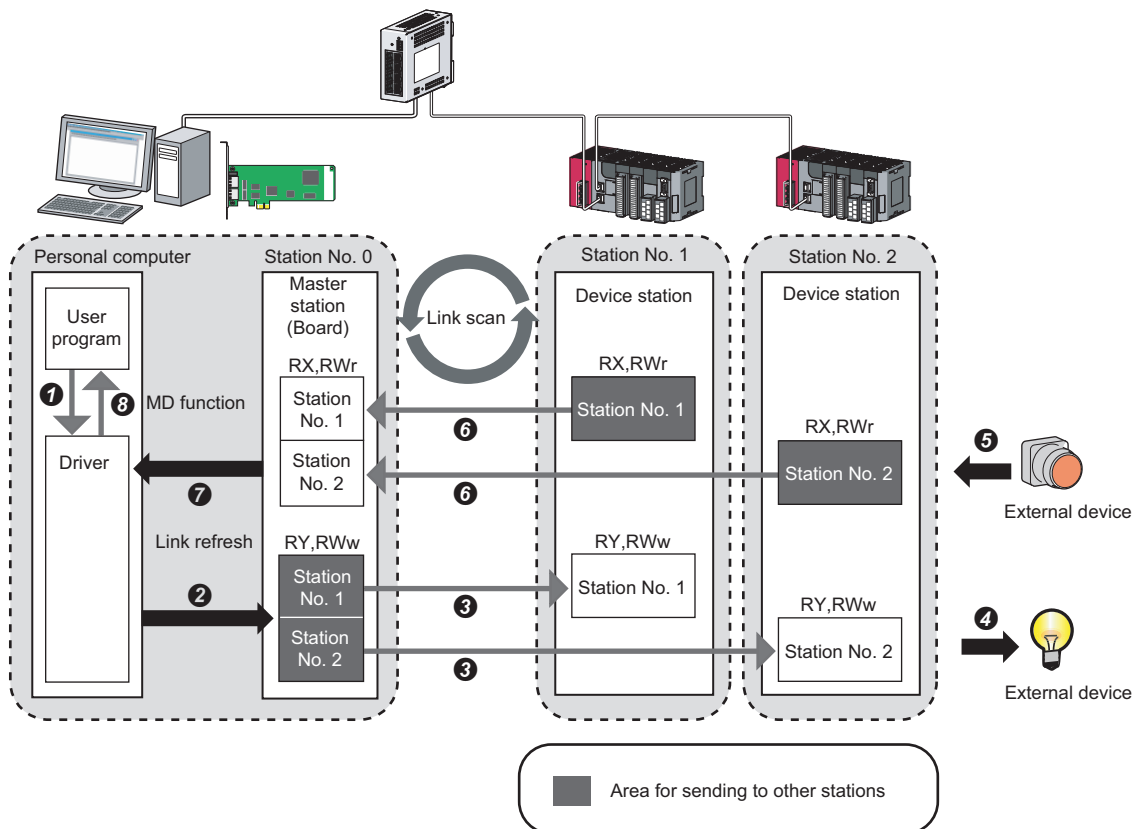

#### • Output from the master station

- ① The status data of the user program are stored in the driver by MD function.
- ② The status data of the driver are stored in the link devices (RY, RWw) of the master station (board) by link refresh.
- ③ The status data of the link devices (RY and RWw) of the master station are stored in the link devices (RY, RWw) of each device station by link scan.
- ④ The status data of the link devices (RY, RWw) of the device station are output to the external device.

#### • Input from the device station

- ⑤ The status data of the external device are stored in the link devices (RX, RWr) of the device station.
- ⑥ The status data of the link devices (RX, RWr) of the device station are stored in the link devices (RX, RWr) of the master station by link scan.
- ⑦ The status data of the link devices (RX, RWr) of the master station (board) are stored in the driver by link refresh.
- ⑧ The status data of the driver are stored in the user program by MD function.

## Master and local stations

Data can be written into the send range of each station's link device (RY, RWw) and can be sent to any station on the same network.

The status data of the link devices (RY, RWw) of the master station are stored in the link devices (RX, RWr) of each local station.

The status data of the link devices (RY, RWw) of local stations are stored in the link devices (RX, RWr) of the master station and the link devices (RY, RWw) of other local stations.

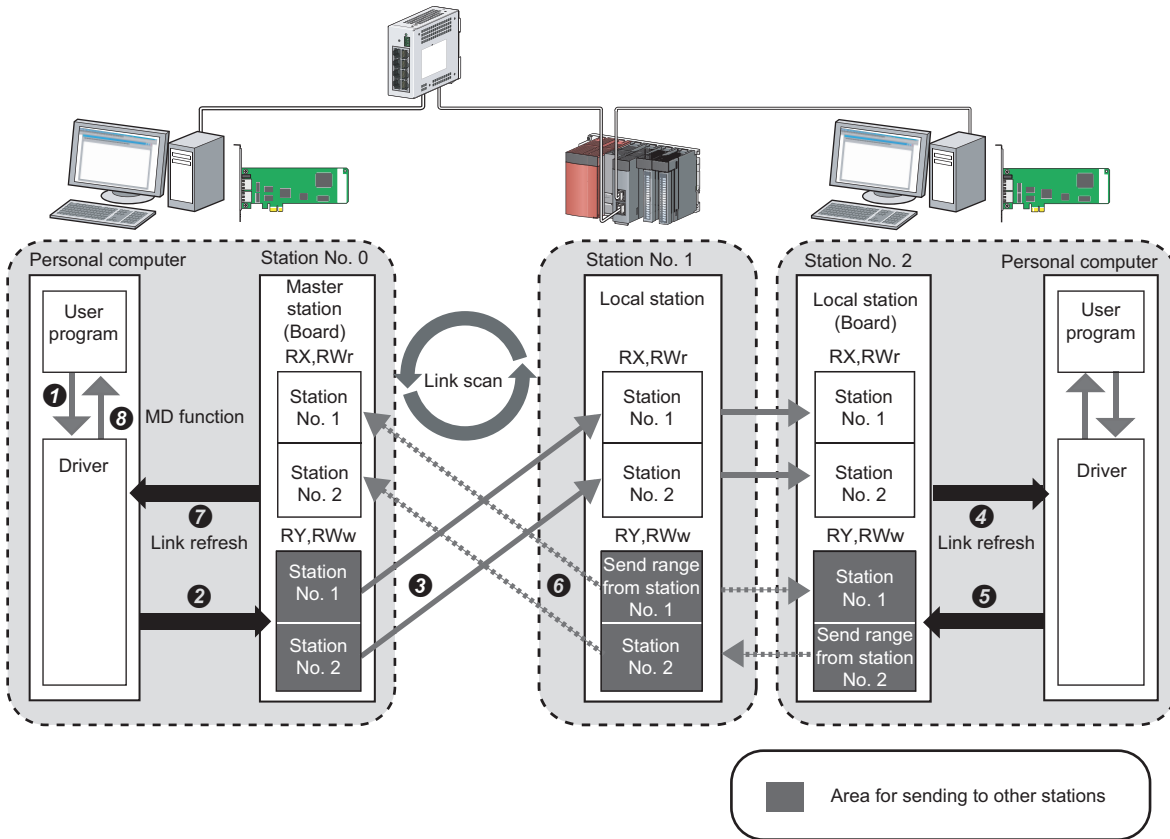

### • Output from the master station

- ① The status data of the user program are stored in the driver by MD function.
- ② The status data of the driver are stored in the link devices (RY and RWw) of the master station (board) by link refresh.
- ③ The status data of the link device (RY, RWw) of the master station is stored in the link device (RX, RWr) of the local station by link scan.
- ④ The status data of the link device (RX, RWr) of the local station (board) is stored in the driver

### • Input from the local station

- ⑤ The status data of the driver is stored in the own station send range of the link device (RY, RWw) of the local station (board) by link refresh.
- ⑥ The status data of the link devices (RY, RWw) of the local station are stored in the link devices (RX, RWr) of the master station by link scan.
- ⑦ The status data of the link devices (RX, RWr) of the master station (board) are stored in the driver by link refresh.
- ⑧ The status data of the driver are stored in the user program by MD function.

## Coexistence of local stations and the other device stations (other than local stations)

The data of all device stations are also stored in the local stations in the same way as the master station.

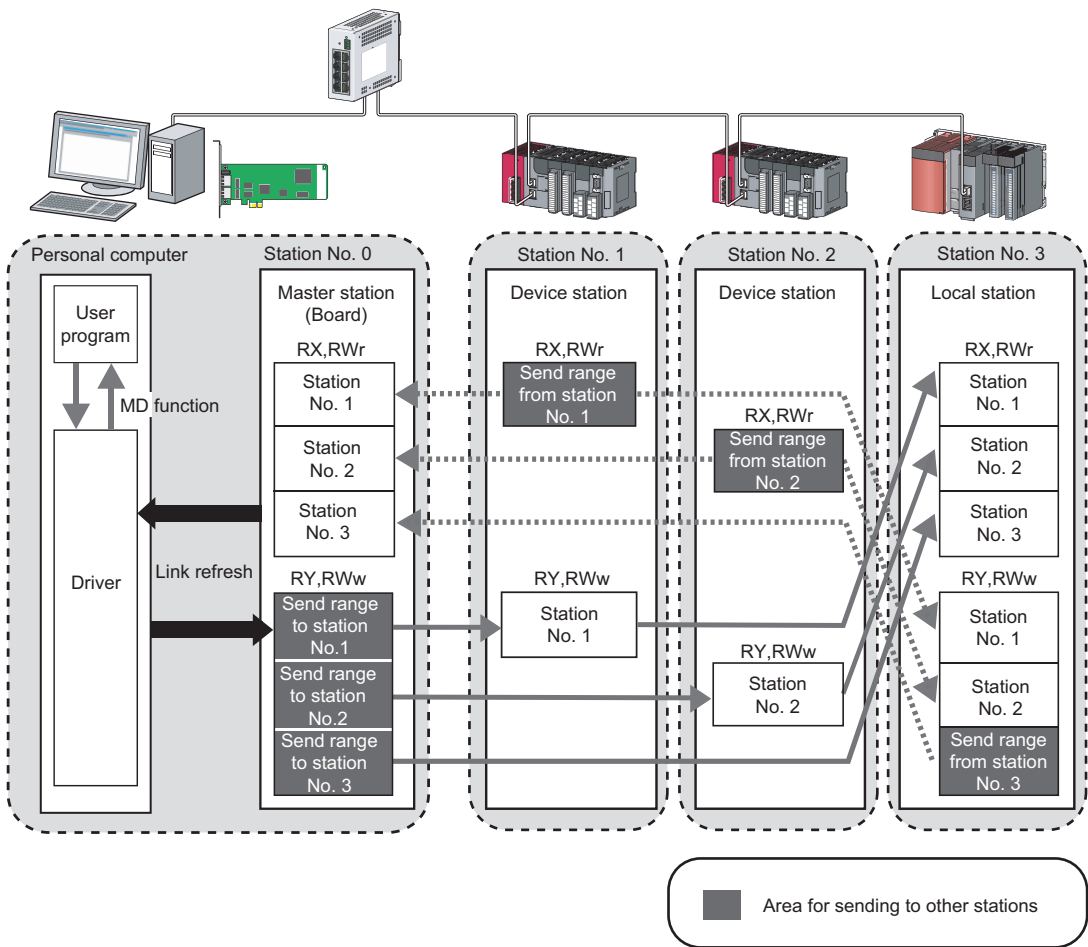

## Setting method

The link devices can be assigned in "Network Configuration Setting". (Page 100 Network configuration setting)

# Link scan and link refresh

Link scan is executed 'asynchronously' with the link refresh which is executed by the CC-Link IE Field Network board driver.

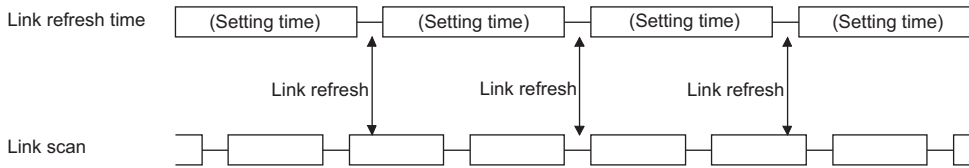

## Setting method

Link refresh is executed at the interval of time set for "Link refresh cycle" in the "Driver setting" screen of CC IE Field Utility. (☞ Page 114 Driver setting)

## Link refresh time

Link refresh time can be checked in the "Board Diagnostics" screen. (☞ Page 125 Diagnosing Board)

The link refresh may not be executed in the set cycle because of such factors described below.

- Performance of the personal computer CPU
- Number of set refresh points
- Number of installed CC-Link IE Field Network boards
- Other running applications
- Other running boards

### Point

- If the link refresh time exceeds the link refresh cycle set in the "Device setting" screen, extend the link refresh cycle. (☞ Page 114 Driver setting)
- If the shortened link refresh time effects the operation of the applications, extend the link refresh cycle. (☞ Page 114 Driver setting)

# Assurance of cyclic data integrity

The cyclic data integrity can be assured in 32-bit units or for each station.

## 32-bit data assurance

The RWw and RWr data can be assured in 32-bit units.

### ■Setting method

Disable "Block Data Assurance per Station" in the "Supplementary Setting" screen in "Network Configuration Setting."

(☞ Page 101 Supplementary setting)

To enable 32-bit data assurance, disable "Block Data Assurance per Station".

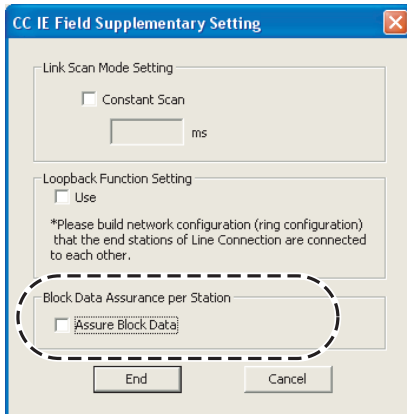

Clear the check box.

### ■Access to cyclic data

When accessing link refresh target devices, the integrity of the 32-bit data can be assured by accessing RWw and RWr with the following conditions satisfied.

- Start device number of RWw/RWr is a multiple of 2.
- The number of points assigned to RWw/RWr is a multiple of 2.



For data assurance of more than 32 bits, use the block data assurance per station or interlock programs.

## Block data assurance per station

Integrity of the cyclic data is assured for each station by handshaking between the driver and the CC-Link IE Field Network board by a link refresh.

### ■Setting method

Enable "Block Data Assurance per Station" in "Supplementary Setting" in "Network Configuration Setting." (  Page 101 Supplementary setting)

Once this setting is enabled on the master station, integrity of the data for all stations is assured for each station.

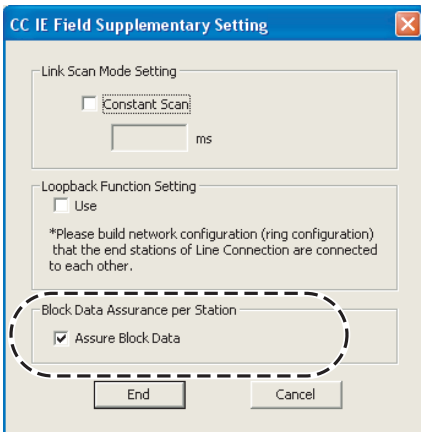

Select the check box.

5

### ■Access to link devices

During a link refresh, data are assured for each station as shown below.

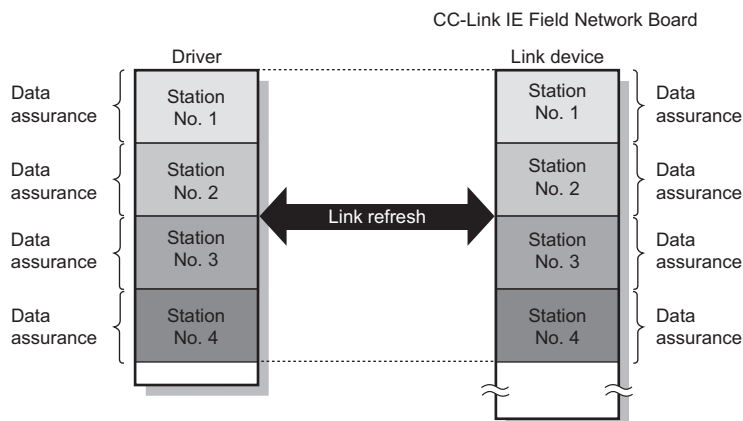

# Input status of data link faulty station setting

Input data from the data link faulty station can be either cleared or held with the CC-Link IE Field Network board.

Input data	Range where the settings are enabled	Input status in case of failure
RX and RY	<ul style="list-style-type: none"> <li>Master station RX</li> <li>Local station RX and RY (only the input data from other stations)</li> </ul>	Clearing or holding the input data can be selected.
RWw and RWr	<ul style="list-style-type: none"> <li>Master station RWr</li> <li>Local station RWw and RWr (only the input data from other stations)</li> </ul>	The input data are held regardless of any setting.

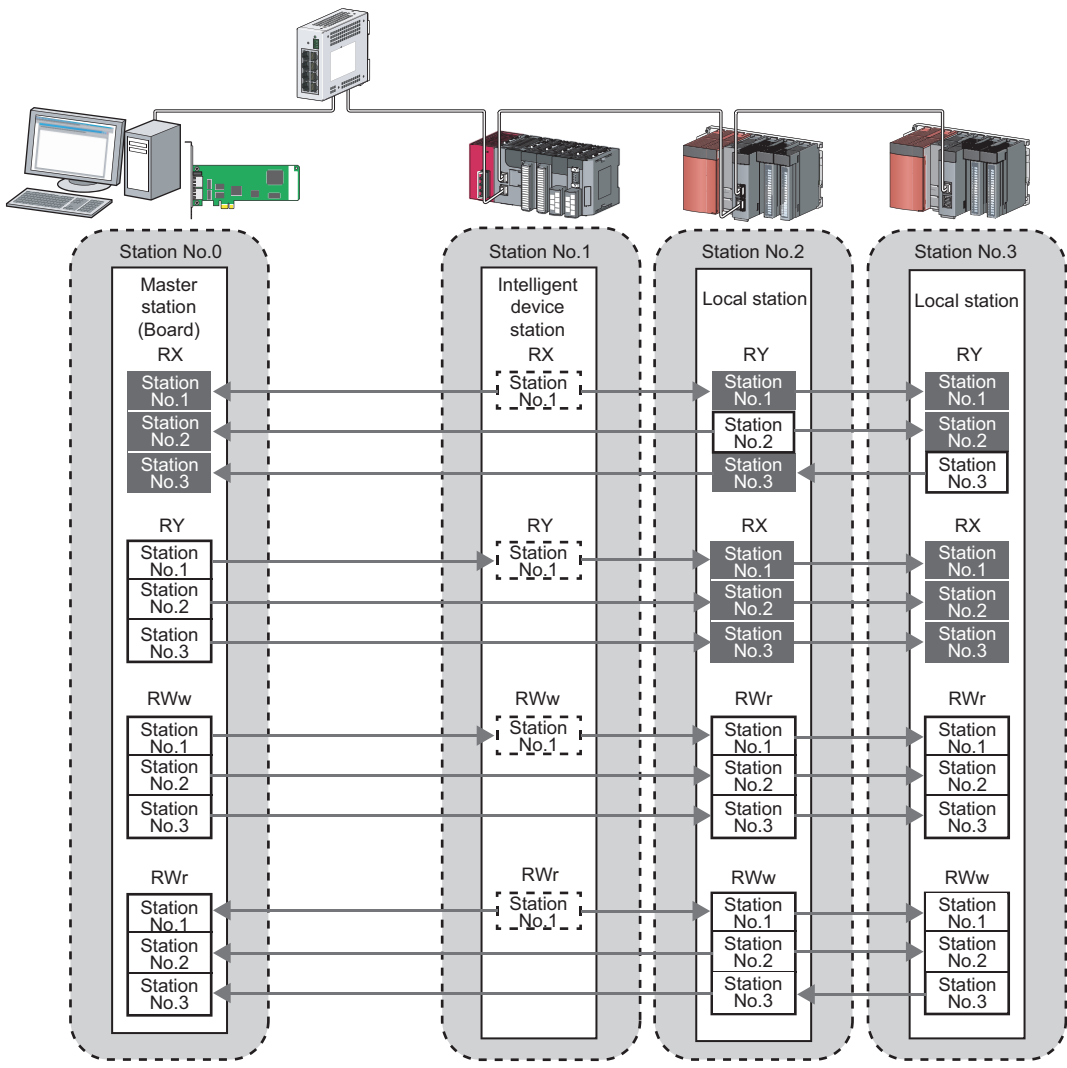
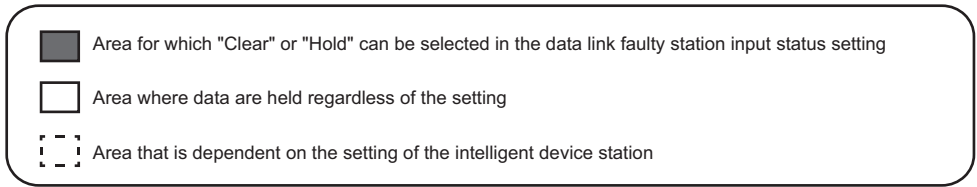

## Setting method

Input status of data link faulty station can be set in the "Network Operation Setting". (☞ Page 112 Network operation setting)

# Cyclic transmission stop and restart

During debugging and other operations, cyclic transmission can be stopped (Data reception from the device stations and data transmission from the own station can be stopped). The stopped cyclic transmission can be restarted. Transient transmission is not stopped.

**Point**

- The link start/stop is not available in loop test mode.
- Cyclic transmission can be started and stopped with link special relay (SB) and link special register (SW).  
(☞ Page 198 Link Special Relay (SB) List, Page 209 Link Special Register (SW) List)

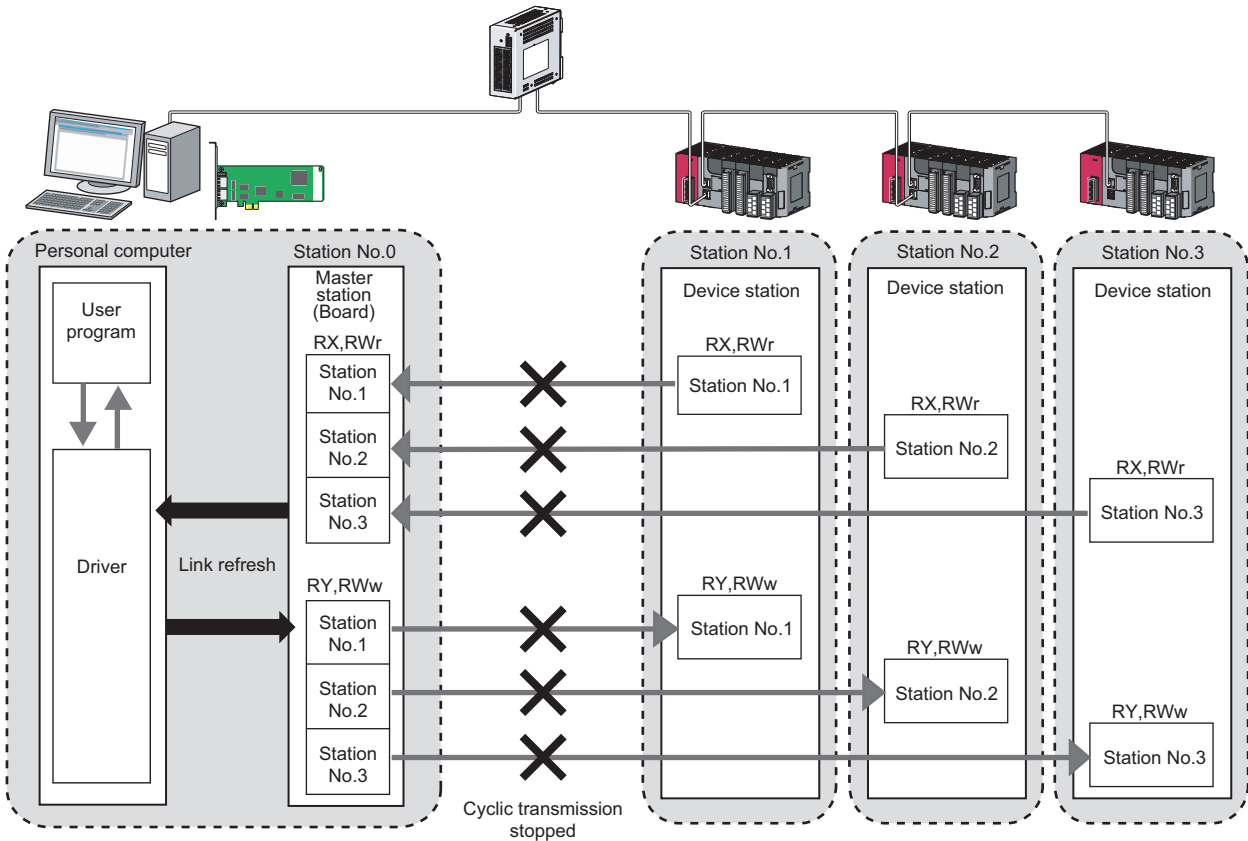

## Setting method

Cyclic transmission stop and restart are operated in the "Link Start/Stop" screen. (☞ Page 140 Link start/stop)

## When the board is reset or the system is powered OFF and then ON

Even if cyclic transmission was stopped by link stop, it will be restarted by resetting the board or powering OFF and then ON the system.

## Stations to which the link start cannot be executed

The link start cannot be executed to the following stations.

- Station where cyclic transmission was stopped due to an error
- Station where link was stopped by a command from another station<sup>\*1</sup>
- Station where link was stopped by link special relay (SB) or link special register (SW)<sup>\*1</sup>

\*1 Selecting "Forced Link Start" will start the link.

## 5.3 Transient Transmission

---

This function allows communication with other stations, using the MELSEC data link library function. Communication is also possible with different networks.

### Communication on the same network

---

Using MELSEC data link library, the programmable controllers of other stations and the buffer memory of the intelligent function module installed with the head module can be accessed. (  Page 146 MELSEC DATA LINK LIBRARY )

#### Setting method

---

Use the MELSEC data link library function.

 MELSEC Data Link Library Reference Manual

#### Transient transmission range

---

It is possible to communicate with all stations on the network.

# Communication with different networks

Setting the routing parameters in utility beforehand enables transient transmission to stations on different networks. Seamless communication is also possible with the CC-Link IE Controller Network, MELSECNET/H.

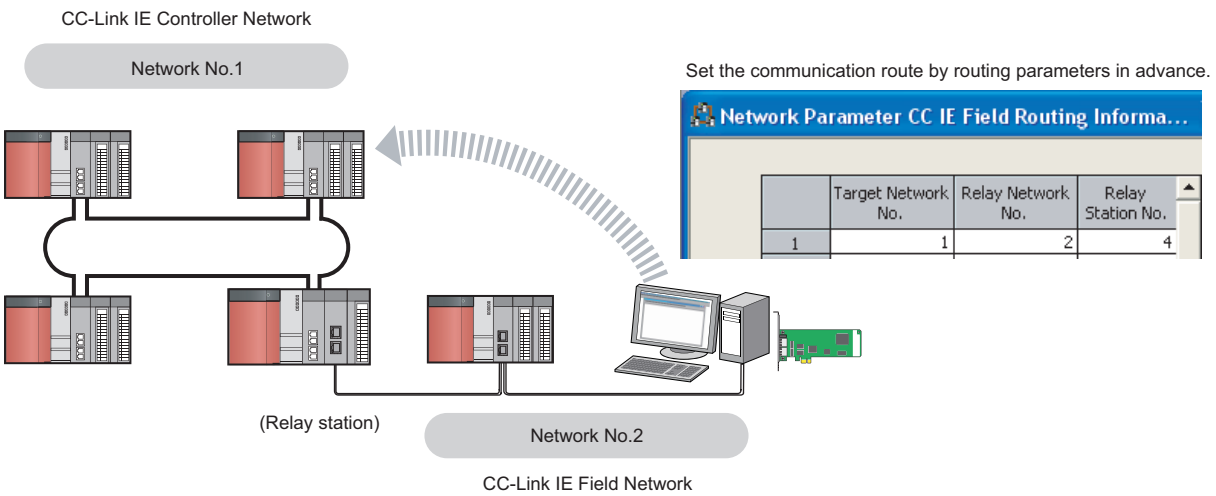

## Setting method

Set the routing parameters in the "Routing Information Setting" screen. (Page 116 Routing parameters)

## Transient transmission range

For Multiple network system, communication with a station on up to the eighth network is possible by setting routing parameters.

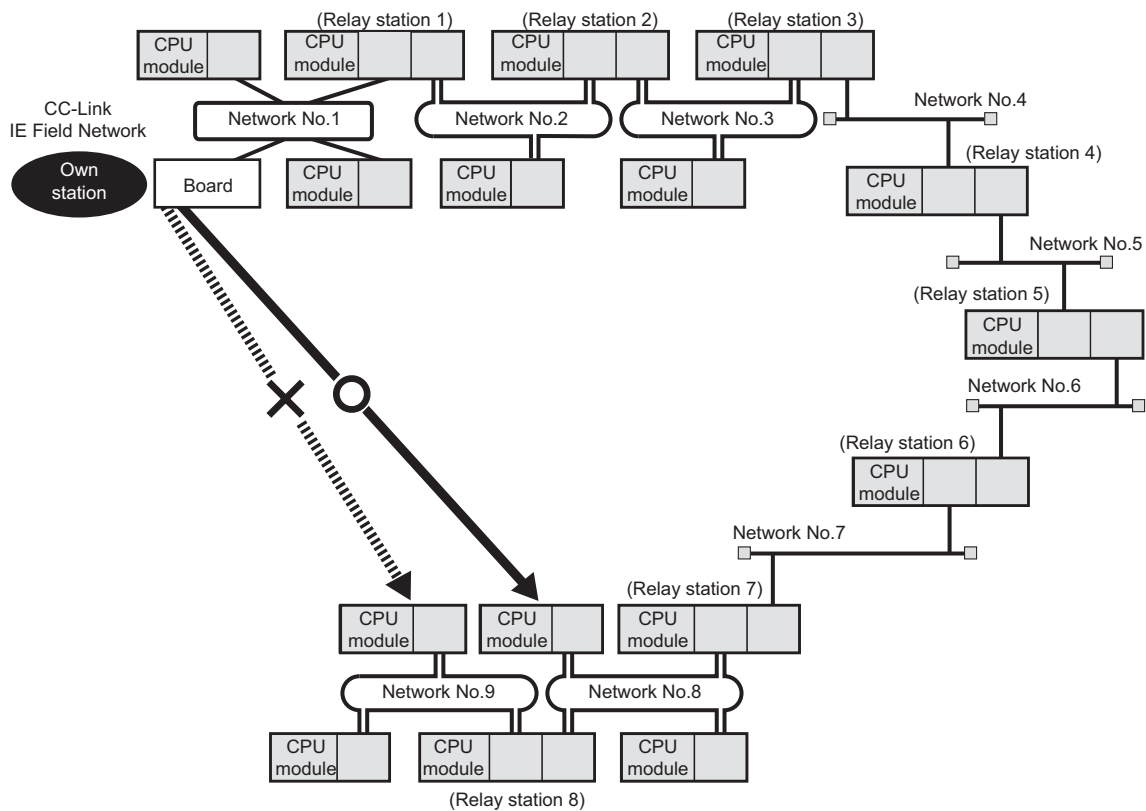

# 5.4 SEND/RECV Function

The SEND/RECV function sends/receives data to/from other station's programmable controller using the MELSEC data link library function. (📖 Page 146 MELSEC DATA LINK LIBRARY)

## Availability by the SW1DNC-CCIEF-B version

For CC-Link IE Field Network board with a serial number whose first five digits are '15102' or higher, install SW1DNC-CCIEF-B version 1.04E or later. When using SW1DNC-CCIEF-B version 1.03D or earlier, one of the following error occurs in the SEND/RECV function and the function cannot be used.

- SEND function: Board driver I/F error :103 (0067H)
- RECV function: Timeout error :2 (0002H)

For an error occurred, refer to the following:

📖 MELSEC Data Link Library Reference Manual

○: Applicable, ×: Not applicable:

Serial number	Version of SW1DNC-CCIEF-B	
	1.03D or earlier	1.04E or later
'14052' or lower	○	○
15102 or higher	×	○

## Channel (use for dedicated instruction)

A channel is an area of a CC-Link IE Field Network board where data handled by a SEND/RECV function is stored. By using multiple channels, it is possible to simultaneously access from the own station to other stations or concurrently read from and write to the same board.

### Number of channels

The CC-Link IE Field Network board has 2 channels that can be used for SEND/RECV function. By using 2 channels simultaneously, the sending and receiving of two data can be executed at the same time.

### Precautions

When executing the sending and receiving of multiple data simultaneously by SEND/RECV function, make sure that the channels for the instructions are not duplicated. The sending and receiving for which the same channel is specified cannot be executed simultaneously. To use the same channel for multiple sending and receiving, execute one after completion of another.

### Example

- When accessing from the own station to multiple other stations simultaneously  
Change the channel used for the own station for each target station.

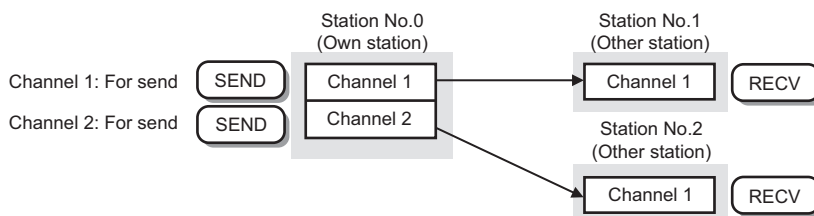

- When accessing mutually between the own station and another station  
Change the channel used for the own station for each sending and receiving of data.

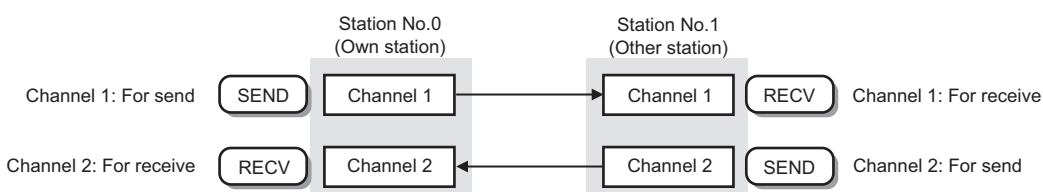

## SEND function

The SEND function sends data from the own station to the specified channel of the specified station using the mdSend/mdSendEx function of MELSEC data link library function.

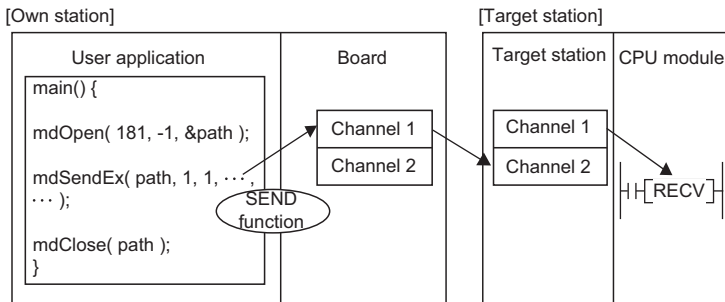

5

### Point

- When sending data to the same channel of the target station  
Send the data after the target station has been read the specified channel data.  
An error will be occurred if sending the data to the same channel of the target station before reading the specified channel data.

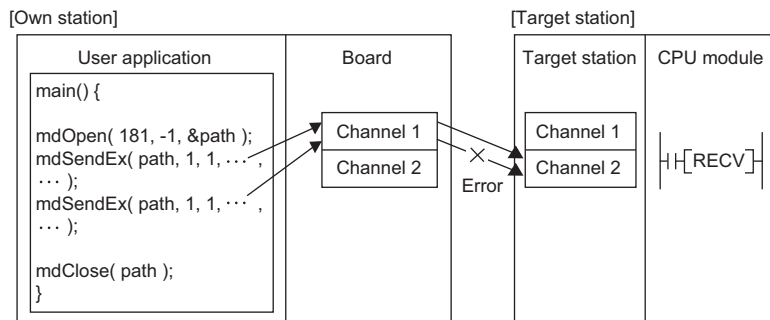

- When the multiple network modules are mounted on the target station  
Specify the station number and network number of the network module which is received the request from the own station.  
The following example specifies the station number 1 of the network number 1. (The station number 5 of the network number 2 cannot be specified.)

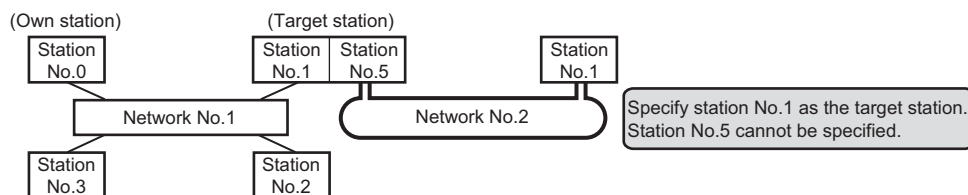

## ■ Execution type

Two execution types, "with arrival confirmation" and "without arrival confirmation", are available for the SEND function. When sending data with "without arrival confirmation" execution type, "All stations" and "Group numbers" can be specified as target stations besides the station number.

- Without arrival confirmation (When the target station is on the same network)

The process is completed when data is sent from the own station.

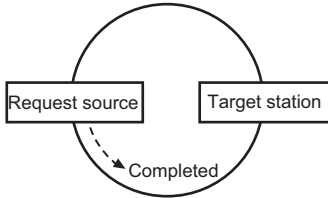

- Without arrival confirmation (When the target station is on another network)

The process is completed when data arrives at the relay station on the same network.

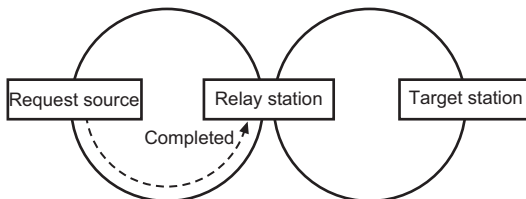

- With arrival confirmation

The process is completed when data is stored in the specified channel of target station.

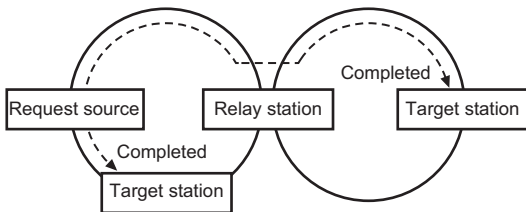

### Point

When "Without arrival confirmation" is specified, the result is regarded as normal on the own station even if the sending to the target station fails as follows.

- When communication ends normally even though sent data are abnormal
- When data cannot be stored in the target station, because data is sent to the same station from multiple stations

## RECV function

The RECV function reads data received from the other station using the mdReceive/mdReceiveEx function of MELSEC data link library function.

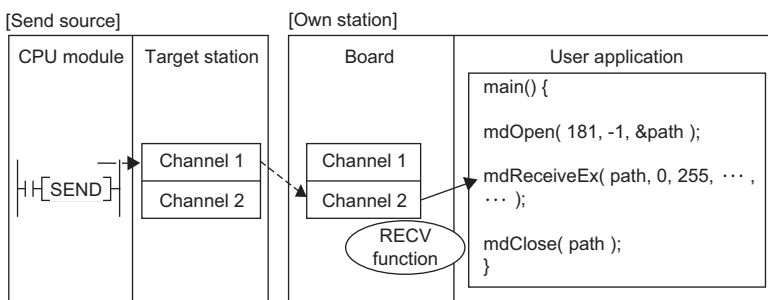

### ■Reception buffer of RECV function

Reception buffer of RECV function is a function in which a driver executes the RECV instruction automatically and received data are stored to reception buffers of each channel number in the driver.

Set the Reception buffer of RECV function in the "driver setting" of the network parameter. (📖 Page 114 Driver setting)

- "Without setting"

When the reception buffer is not set, the operation is the same as the RECV function of link dedicated instruction for CPU.

This setting is used for detecting errors in sent data, whose execution type of the SEND function is set to "with arrival confirmation", at sending side.

- "With setting"

When the reception buffer is set, the operation is the same as the RECV function for MELSECNET/H board or CC-Link IE Controller Network board.

This setting is used for receiving data from multiple stations such as data sampling.

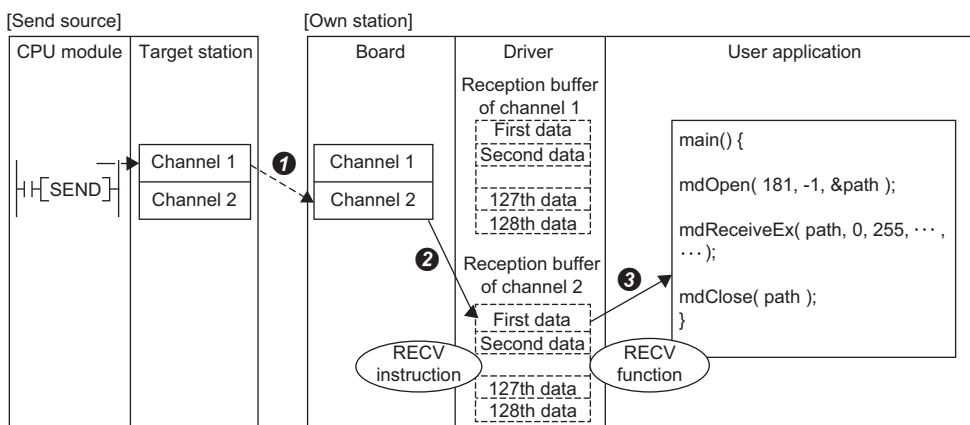

- ① Data received from other stations is stored to a storage channel of the target station specified in the send source.
- ② The driver executes the RECV instruction automatically and stores the received data to reception buffers of each channel number from the storage channel of the target station.  
A maximum of 128 reception data are stored to each reception buffer of each channel number in the driver. When received data exceeds 128, the driver discards the received data automatically.
- ③ Using the mdReceiveEx/mdReceive function, data of the specified channel number are read from the reception buffer in the order they were received.

When the reception buffer is set, an error may occur under the following condition.

Condition	Description	Corrective action
Data are read immediately after the send data completion at the sending station.	When attempting data read by executing the mdReceive/mdReceiveEx function immediately after the send data completion at the sending station, "No reception data error" occurs because data have not yet been stored to the reception buffer of the driver.	• Retry it after a little while.
Data are sent consecutively from the sending station.	When attempting data send consecutively, "Channel busy (dedicated instruction) error" occurs at the sending station because the channel is being used by the driver and thus the sent data cannot be received.	• Retry it after a little while. • Change the storage channel of the target station.
Normally completed data at the sending side are discarded.	When 128 received data are stored to the reception buffer of each channel number, the 129th and the following received data are discarded automatically by the driver after they are received by the board and before they are stored to the reception buffer. When the data, whose execution type is set to "with arrival confirmation", are sent from the sending side, a normal completion is established at the sending side because the board receives data once, however, data are discarded.	• Retry it after a little while.

## ■Event notification

The event notification can be set to receive in the user program when receiving data.

The event notification is set in the event setting of the network parameter. (📖 Page 112 Event setting)

	Device Code	Device No.	Detection Method	Event Condition	Word Device Setting Value	Channel No.	Event No.
1	RECV Function		Edge Detect			1	0
2							

Received data can be obtained as events in a user program by specifying event numbers set in the event setting using the mdWaitBdEvent function. (The received data are read by executing the mdReceiveEx/mdReceive function after the return of the mdWaitBdEvent function.)

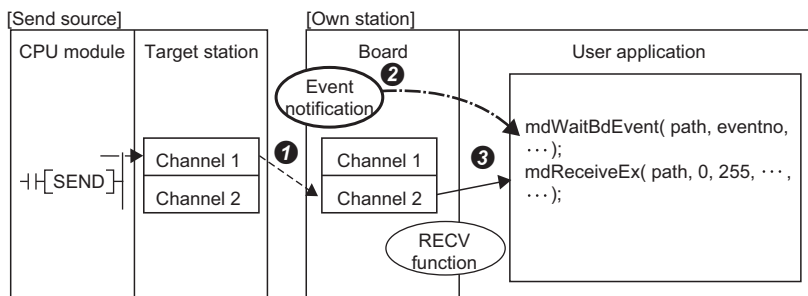

- ❶ Messages received from other stations are stored to a storage channel of the target station specified in the send source.
- ❷ Specified events are notified and the mdWaitBdEvent function completes normally.  
At this time, the received channel number is stored to the detailed event information of the mdWaitBdEvent function.
- ❸ Data of channel number notified by the mdWaitBdEvent function are read from the reception buffer using the mdReceiveEx/mdReceive function.

### Point

When setting the event notification function, set "Without setting" for Reception buffer of RECV function.

## ■Operational change according to the setting of the RECV function

- RECV execution request flag

When receiving data from another station, the RECV execution request flag status of link special relay (📖 Page 198 Link Special Relay (SB) List) is set as follows according to each setting.

Reception buffer of RECV function	Event setting of channel that received data	RECV execution request flag when data from another station are received (SB0030, SB0031)
With setting	(Event setting is not applicable.)	No change
Without setting	With event setting	
	Without event setting	Flag turns ON

- When data are not received at the execution of mdReceiveEx/mdReceive function

The action when data are not received at the execution of mdReceiveEx/mdReceive function is set as follows according to each setting.

Reception buffer of RECV function	Event setting of channel that received data	Operation status of mdReceiveEx/mdReceive function
With setting	(Event setting is not applicable.)	The function ends with an error. (No reception data error)
Without setting	With event setting	
	Without event setting	The function waits for up to the time specified for "Transient timeout monitoring time". (📖 Page 114 Driver setting) When data are received: The function ends normally. When data are not received: The function ends with an error. (Response timer timeout (dedicated instruction))

# 5.5 Reserved Station Specification and Reserved Station Function Disable Function

Reserved station specification allows setting of a station that is not actually connected at present but will be connected to the network in the future (must be included in the total number of stations for the network). Reserved stations are not detected as error stations even though they are not actually connected.

When the reserved station function is disabled, a device station specified as a reserved station can be canceled temporarily.

## Reserved station specification

A device station can be specified as a reserved station in the "Network Configuration Setting". (☞ Page 100 Network configuration setting)

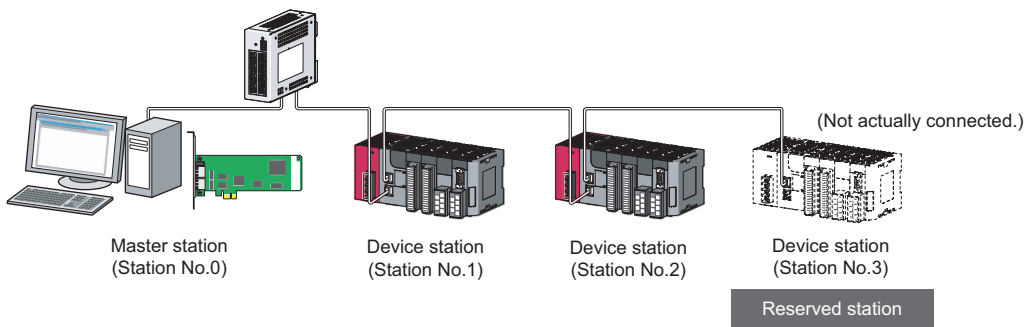

Network Configuration Setting

Number of PLCs	Station No.	Station Type	RX/RX Setting			RWw/RWr Setting			Reserved/Error Invalid Station
			Points	Start	End	Points	Start	End	
1	1	Local Station	16	0000	000F	8	0000	0007	No Setting
2	2	Intelligent Device Station	16	0010	001F	8	0008	000F	No Setting
3	3	Intelligent Device Station	16	0020	002F	8	0010	0017	Reserved Station

Select "Reserved Station".

## Reserved station function disable and cancel

This is used when connecting a reserved-status device station to the network.

Reserved station function disable and cancel is set in the "Reserved Station Function Enable" screen. (☞ Page 143 Reserved station function enable)

# 5.6 Error Invalid Station and Temporary Error Invalid Station Setting Function

When a device station is set as an error invalid station, even if it is disconnected from the network during data link, the master station will not detect it as error station.

Furthermore, by the temporary error invalid station setting function, a device station can be temporarily set as an error invalid station.

## Error invalid station setting

A device station can be set as an error invalid station in "Network Configuration Setting". (Page 100 Network configuration setting)

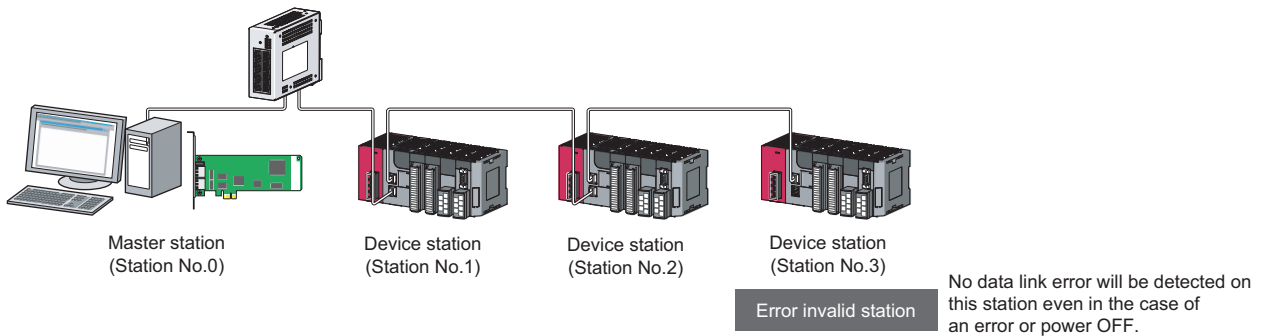

Network Configuration Setting

Number of PLCs	Station No.	Station Type	RX/RV Setting			RWw/RVr Setting			Reserved/Error Invalid Station
			Points	Start	End	Points	Start	End	
1	1	Local Station	16	0000	000F	8	0000	0007	No Setting
2	2	Intelligent Device Station	16	0010	001F	8	0008	000F	No Setting
3	3	Intelligent Device Station	16	0020	002F	8	0010	0017	Invalid Station

Select "Invalid Station".

## Temporary error invalid station

This function is useful for various operations such as replacing a device station during a data link by temporarily setting it as an error invalid station.

For setting the temporary error invalid station, refer to the following:

Page 144 Enable/Disable ignore station errors

# 5.7 Event Function

This function checks event conditions every link scan, and notifies events to the user program when the event conditions are met.

By using the event function, the link devices can be monitored efficiently without reading link devices regularly by the user program.

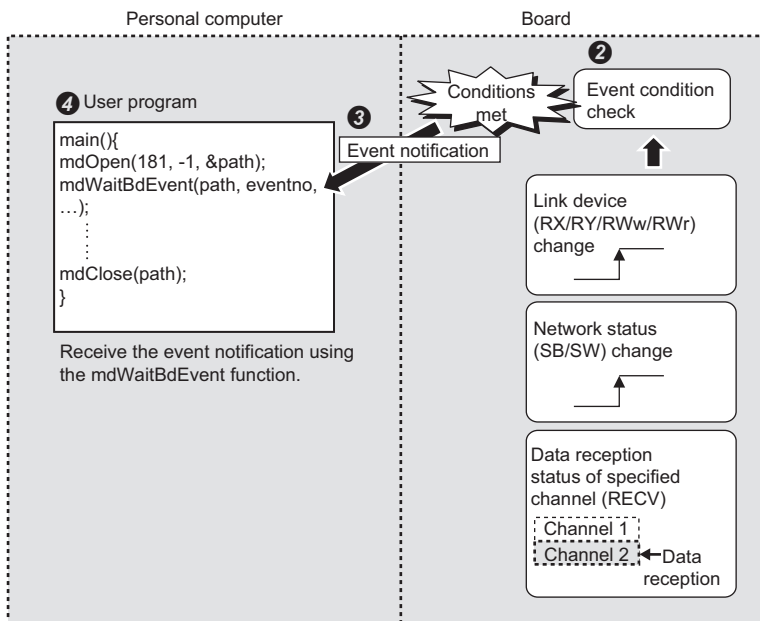

1 Setting of event condition

Device Code	Device No.	Detection Method	Event Condition	Word Sense Setting Value	Channel No.	Event No.
1	RX	0000 Edge Detect	ON			0
2	RY	0000 Edge Detect	OFF			1
3	RWw	0000 Edge Detect	Equal	10		10
4	RECV Function	Edge Detect			1	11
5						
6						
7						
8						
9						
10						
11						
12						
13						
14						
15						
16						

- 1 Set the event condition.
  - 2 Link devices set for the event condition are checked every link scan.
  - 3 When the event conditions are met, an event notification is issued every link refresh cycle.
- ☞ Page 114 Driver setting
- 4 Receive the event notification using the mdWaitBdEvent function in the user program.

## Setting method

Event conditions are set in the "Event setting" screen. (☞ Page 112 Event setting)  
Specify event numbers set by the mdWaitBdEvent function of MELSEC data link library.

# 5.8 Loopback Function

The loopback disconnects the station in which an error has occurred from the network and continues data link with the stations that are operating normally. Stations connected after the faulty station can also continue data link.

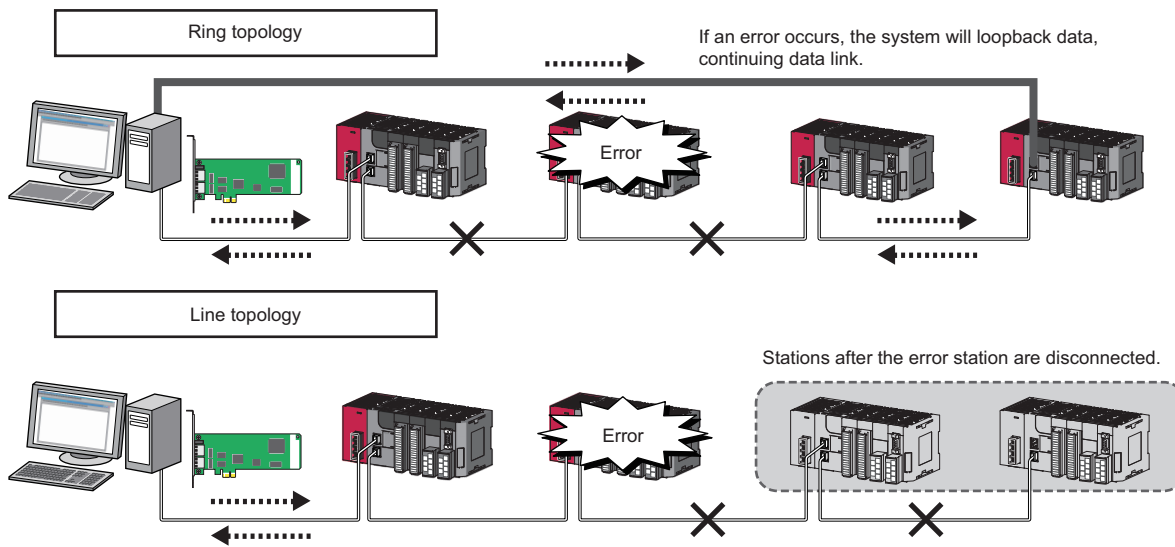

## Setting method

Configure the network in ring topology and set "Use" for "Loopback Function Setting" in the "Supplementary Setting" screen in "Network Configuration Setting." (Page 101 Supplementary setting)

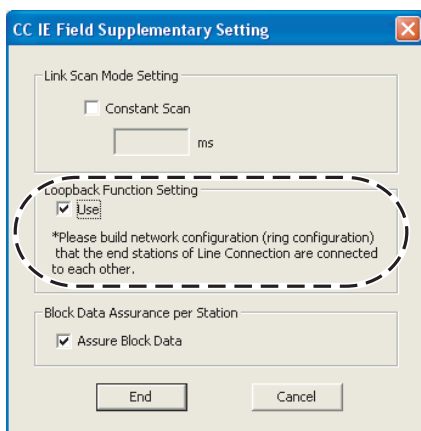

Select the check box.

## Precautions

For network topology other than ring topology, clear the check box.

If the loopback function setting and the network configuration are inconsistent, an error may occur in all stations and data link cannot be performed.

### Point

Whether loopback is being performed or not can be checked by link special relay (SB) and link special register (SW) for the master station. (Page 198 Link Special Relay (SB) List, Page 209 Link Special Register (SW) List)

## 5.9 Driver WDT function

The driver WDT function monitors the operation of the software (operating system, driver) using the timer function on CC-Link IE Field Network board.

When the driver cannot reset the timer of the board within the specified driver WDT monitoring time, CC-Link IE Field Network board detects driver WDT error. Driver WDT function detects driver operation delay due to the access error from the driver to CC-Link IE Field Network board or system high load.

### Driver WDT settings

For the setting methods, refer to the following:

 Page 114 Driver setting

#### Point

The driver WDT function is set to invalid as a default.

### When the driver WDT error has occurred

The following shows the operation when driver WDT error has occurred.

- CC-Link IE Field Network board and the driver stop communication and are disconnected from the network in order to avoid an erroneous output. When the Driver WDT function confirmed the CC-Link IE Field Network board in which a driver WDT error is occurred from other station, a CPU stop error occurs.
- RUN LED flicks and RD. LED turns ON on the CC-Link IE Field Network board.
- "-28158 (9202H) Driver WDT error" occurs when accessing CC-Link IE Field Network board from the application program in which the CC IE Field Utility and MELSEC data link library function are used.

#### Point

When the multiple application programs in which MELSEC data link library is used are executed, driver WDT error is returned to all the programs. However, only the CC-Link IE Field Network board in which the driver WDT error has occurred is recognized as an error station on the network. When using driver WDT function, set the monitoring time considering the margin of the personal computer load.

For the troubleshooting, refer to the following:

 Page 150 TROUBLESHOOTING

# 6 INSTALLING AND UNINSTALLING SOFTWARE PACKAGES

---

This chapter explains the software package installation and uninstallation.

## 6.1 Installation and Uninstallation Precautions

---

The following are the precautions when installing and uninstalling the software package.

- Log on as a user with the administrator authority.
- Make sure to close other applications running on Windows (including resident software such as antivirus software) before installation and uninstallation.
- The installer may not work normally because the update program of operating system or other companies' software such as Windows Update and Java® update may start automatically. Please install the driver after changing the setting of the update program not to start automatically.
- Check if the display settings on the [Device Manager] of Windows are correct, then install an appropriate display driver, or update the Windows.
- The language switching function of the operating system set in Windows settings is not supported. The installation or uninstallation may not work normally if the language setting is changed.
- Enable the .NET Framework 3.5 (including .NET 2.0 or 3.0) in "Turn Windows features on or off" on the control panel.
- A network drive cannot be specified as the installation destination.
- When the parameters have been set with the utility installed, the parameters are initialized at installation. Save the parameters with the save file function before installing the utility.
- When the software package has been installed in the environment that the creation of 8.3 filename is disabled, the software package may not be uninstalled. Enable the creation of 8.3 filename before installing the software package. For the method on how to check and change the status of 8.3 filename creation to enable/disable, refer to the website of Microsoft Corporation.
- To Windows Server 2016, apply Windows Updates (KB4132216, KB4091664, KB4465659, and KB4534307).
- When installing the software package, enable the user account control. (🔒 Page 234 Windows User Account Control)
- When the version of software package to be installed is Ver.1.17T or later, the software package the version of which is Ver.1.16S or earlier must be uninstalled in advance.

# 6.2 Installation

The following explains a procedure for installing the software package.

## Obtaining the software

Please contact your local Mitsubishi Electric sales office or representative.

## Installation procedure

1. Save the obtained data for installation to the system drive, DVD, etc.
2. Start the installer.  
Double-click "Setup.exe" in the folder.
3. Follow the on-screen instructions to select or enter the necessary information.  
When actions displayed in the screen are not clear, refer to the following:  
  - ☞ Page 155 Action displayed in the screen is not effective while installation
4. Restart the personal computer.

## When installation is completed normally

The driver and utilities for a board, etc. are registered.

When using other network interface boards on the same personal computer, refer to the following:

☞ Page 80 Considerations for using other boards on a personal computer

### Utilities and manuals

When the installation is completed normally, the utilities and the manual shown below are registered in the "Start" of Windows.

Folder	Name	Description
MELSEC	CC IE Field Utility (Board)	Starts CC IE Field Utility. It is a utility to set boards and display the status.
	CC IE Field Board Program Sample	A folder in which sample programs are stored.
	CC IE Field Board Manual <sup>*1</sup>	Displays this manual PDF.
MELSEC <sup>*2</sup>	Device Monitor Utility (Board)	Starts Device Monitor Utility. It is a utility to monitor devices and change the current value.
MELSOFT	e-Manual Viewer	Displays the manual.
	e-Manual Viewer Help	

\*1 When using 64-bit version operating system, the icon may not be displayed even when Adobe Acrobat Reader is installed.

\*2 Not registered in the MELSEC folder if already registered in the MELSOFT folder.

If Device Monitor Utility or e-Manual Viewer is previously installed, it is overwritten in the same folder.

### Point

- For the functions and handling methods, refer to the manual of the installed software package.
- The specifications of software package described in e-Manual, which are updated in e-Manual Viewer, may be different from the ones of installed software package.

## MELSEC Data Link Library

The MELSEC data link library is a library used to access own station link devices of a board and device memory of programmable controller CPUs of other stations using a board. The library is stored in the 'Common' folder in the folder where it is installed.

## Driver

When installing the board on the personal computer after the installation of the software package, the driver is installed automatically.

When the driver installation is completed normally, the following driver is displayed in the Device Manager screen of Windows.

Device name	Driver name
MELSEC CC-Link IE Field Device	MELSEC CC-Link IE Field Controller

## Service application

To prevent a personal computer from entering the power save mode (hibernate, sleep), MELSECPowerManager is installed automatically.

For details on MELSECPowerManager, refer to the following:

 Page 236 MELSECPowerManager

## Considerations for using other boards on a personal computer

Device Monitor Utility, MELSEC data link library, and MELSECPowerManager are used in common for the following software packages of other network interface boards:

- SW1DNN-CCIETBDM-B
- SW1DNC-MNETG-B
- SW1DNC-CCIEF-B
- SW1DNC-CCBD2-B
- SW0DNC-MNETH-B

The newer software package data is validated when installing them on the same personal computer.

### Point

For the functions and handling methods of Device Monitor Utility and MELSEC data link library, refer to the manual that can be displayed from the menu in Device Monitor Utility.

## When installation is aborted or failed

When the installation is aborted or failed, take corrective actions following the troubleshooting.

 Page 153 Installation failed

## 6.3 Uninstallation

---

This section explains a procedure for uninstalling the software package.

### Uninstallation procedure

---

1. Uninstall the software package from the control panel of Windows.

#### Point

- Save parameters as necessary before uninstallation.
- When a screen confirming the deletion of common files appears at uninstallation:  
Select "No to All." If deleting common files, other applications may not run normally.
- When a screen confirming the execution of restart appears at the completion of uninstallation:  
Select "Yes, I want to restart my computer now.", and restart the personal computer.
- MELSECPowerManager may not be uninstalled due to the compatibility with other installed software packages.

For details on MELSECPowerManager, refer to the following:

 Page 236 MELSECPowerManager

---

### When uninstallation is completed normally

---

When the uninstallation is completed normally, the icons registered in the Windows Start are deleted.

### When uninstallation is failed

---

When the uninstallation is failed, take corrective actions following the troubleshooting.

 Page 153 Uninstallation failed

# 7 OVERVIEW OF CC IE FIELD UTILITY

CC IE Field Utility is software to display settings and status of the CC-Link IE Field Network board.

For installing and uninstalling CC IE Field Utility, refer to the following:

☞ Page 78 INSTALLING AND UNINSTALLING SOFTWARE PACKAGES

## 7.1 Overview

Use CC IE Field Utility to perform the following functions.

Item	Description	Menu	Reference
Test before wiring	Bus I/F test	[Diagnostics] ⇒ [Board Diagnostics]	Page 45 Bus I/F test
	Memory test		Page 45 Memory test
	Hardware test		Page 46 Hardware test
	Self-loopback test		Page 47 Self-loopback test
Setting	Parameter Setting	[View] ⇒ [Network Parameter] [Online] ⇒ [Read from Board]/[Write to Board]	Page 97 SETTING PARAMETERS Page 121 Writing/Reading Parameters to/from Board
	Channel number setting	[Online] ⇒ [Channel No. Setting]	Page 120 Setting Board Channel Numbers
Test after wiring	Loop test	[Diagnostics] ⇒ [Board Diagnostics]	Page 52 Loop test
	Cable test	[Diagnostics] ⇒ [CC IE Field Diagnostics]	Page 53 Cable test
	Communication test		Page 54 Communication test
Monitor/ Debug	Device monitor	[Online] ⇒ [Device Monitor Utility]	Page 123 MONITORING
	CC-Link IE Field Network diagnostics	[Diagnostics] ⇒ [CC IE Field Diagnostics]	Page 127 Diagnosing CC-Link IE Field Network
	Reset operation	[Online] ⇒ [Reset Operation]	Page 122 Resetting Board

## 7.2 Menu List

This section explains functions of CC IE Field Utility.

<b>[Project]</b>		<b>Reference</b>
⇒ [New]	Creates a new project.	Page 90 Creating Projects
⇒ [Open]	Opens an existing project.	Page 91 Opening Existing Projects
⇒ [Close]	Closes an open project.	Page 95 Closing Projects
⇒ [Save]	Saves a project.	Page 92 Saving Projects
⇒ [Save As]	Names and saves a project.	
⇒ [Compress/Unpack] ⇒ [Compress]	Compresses and saves a project.	Page 93 Saving Projects with Compression and Unpacking Projects
⇒ [Compress/Unpack] ⇒ [Unpack]	Unpacks a compressed project.	
⇒ [Delete]	Deletes an existing project.	Page 95 Deleting Projects
⇒ [Verify]	Verifies data of an open project and data of other projects.	Page 96 Verifying Project Data
⇒ [(The latest file 1 to 4)]	Displays the recently used CC IE Field Utility project paths and opens the selected project.	—
⇒ [Exit]	Exits CC IE Field Utility.	Page 84 Starting and Exiting
<b>[Edit]</b>		<b>Reference</b>
⇒ [Cut]	Cuts the selected data.	—
⇒ [Copy]	Copies the selected data.	
⇒ [Paste]	Pastes the cut or copied data at the cursor position.	
<b>[View]</b>		<b>Reference</b>
⇒ [Network Parameter]	Sets the network parameters.	Page 97 SETTING PARAMETERS
⇒ [Toolbar] ⇒ [(Toolbar name)]	Displays/hides the toolbar.	Page 86 Toolbars
<b>[Online]</b>		<b>Reference</b>
⇒ [Channel No. Setting]	Displays/changes board channel numbers.	Page 120 Setting Board Channel Numbers
⇒ [Read from Board]	Reads parameters from the board.	Page 121 Writing/Reading Parameters to/from Board
⇒ [Write to Board]	Writes parameters to the board.	
⇒ [Verify with Board]	Verifies parameters set to the board and parameters of open project.	Page 122 Verifying Parameters of Board and Project
⇒ [Reset Operation]	Resets the board.	Page 122 Resetting Board
⇒ [Device Monitor Utility]	Starts Device Monitor Utility.	Page 123 MONITORING
<b>[Diagnostics]</b>		<b>Reference</b>
⇒ [Board Diagnostics]	Diagnoses the operating status of the board.	Page 125 Diagnosing Board
⇒ [CC IE Field Diagnostics]	Diagnoses the CC-Link IE Field Network.	Page 127 Diagnosing CC-Link IE Field Network
<b>[Window]</b>		<b>Reference</b>
⇒ [Cascade]	Tiles windows in overlapping display.	—
⇒ [Tile Vertically]	Tiles windows vertically.	
⇒ [Tile Horizontally]	Tiles windows horizontally.	
⇒ [Arrange Icons]	Arranges the icons at the bottom of the window.	
⇒ [Close All]	Closes all open windows.	
⇒ [(Window information being displayed)]	Displays the open window.	
⇒ [Window]	Displays a list of open windows. And opens and arranges specified windows.	Page 87 Work windows
<b>[Help]</b>		<b>Reference</b>
⇒ [Manual]	Displays the manual.	Page 89 Help Function
⇒ [About]	Displays product information such as the version.	

# 8 SCREEN CONFIGURATION AND BASIC OPERATIONS

This chapter explains the screen configuration and basic operations of CC IE Field Utility.

## 8.1 Starting and Exiting

This section explains the operation methods for starting and exiting CC IE Field Utility.

### Starting up

Start up CC IE Field Utility.

#### Operating procedure

1. Windows Start ⇒ [MELSEC] ⇒ [CC IE Field Utility (Board)]

#### Point

Starting CC IE Field Utility when the user account control is enabled

When CC IE Field Utility is started while the user account control (UAC) is enabled, the following warning screen appears. Click the [Yes] button to start the utility.

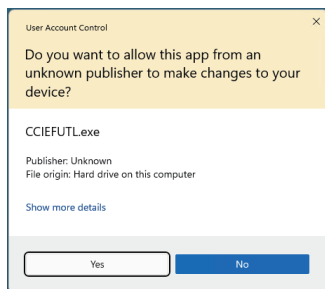

### Exiting

Exit CC IE Field Utility.

#### Operating procedure

1. Select [Project] ⇒ [Exit]

# 8.2 Screen Configuration and Basic Operations

This section explains the main frame (basic screen) of CC IE Field Utility that is displayed when it is started up.

## Main frame configuration

The following shows a main frame configuration.

### Window

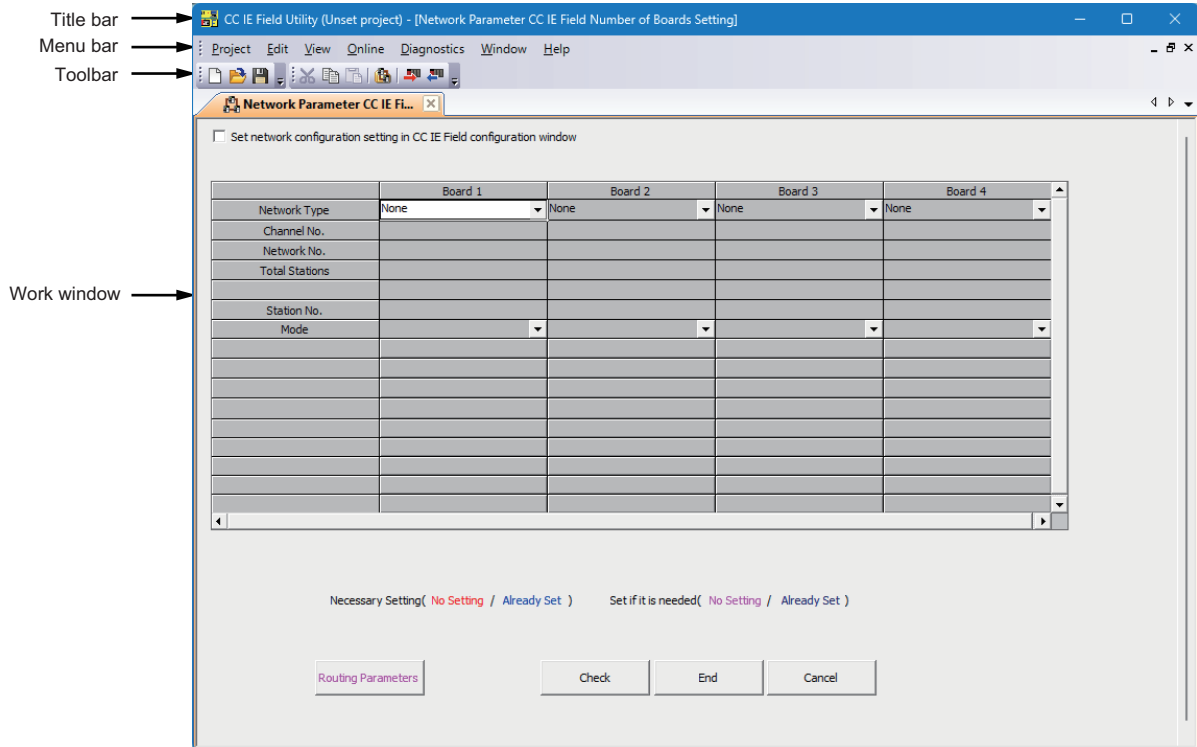

### Displayed items

Name	Description	Reference
Title bar	Displays a project name.	—
Menu bar	Displays menu options for executing each function.	—
Toolbar	Displays tool buttons for executing each function.	Page 86 Toolbars
Work window	A main screen used for operations such as parameter setting, and monitoring.	Page 87 Work windows

# Toolbars

A toolbar is a block of on-screen buttons for executing frequently-used functions included in a menu. The toolbars to be displayed and their display positions on the screen can be set by the user.

## Displaying/hiding toolbars

Select a toolbar to be displayed.

### Operating procedure

1. Select [View] ⇒ [Toolbar] ⇒ [(toolbar name)]

The selected toolbar is displayed in the screen.



## Switching the Docking/floating of toolbars

Switch the display format (docking/floating) of a toolbar.

### ■Floating a toolbar

Displays a toolbar floating from the main frame.

### Operating procedure

1. Drag a docked toolbar to the desired position for floating display.

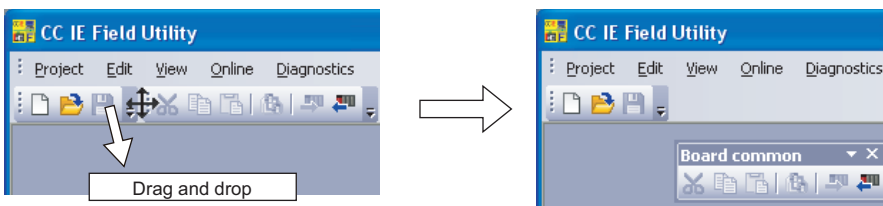

### ■Docking a toolbar

Displays a toolbar docked to the main frame.

### Operating procedure

1. Drag the title bar of a floating toolbar and drop it in the main frame.

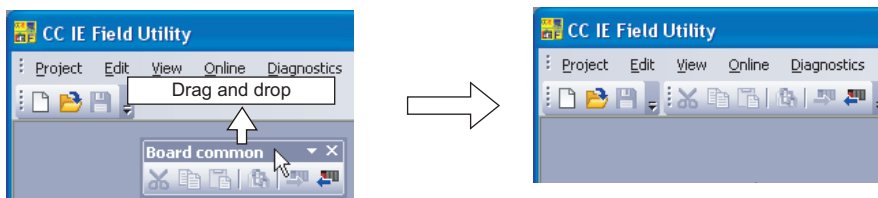

### Point

- Method for docking a toolbar at the original position  
To dock a floating toolbar back at the original position, double-click on the title bar of the toolbar.

## Customizing toolbars

This function sets the types of tool buttons to be displayed in each toolbar.

### Operating procedure

1. Select (  button) ⇒ [Add or Remove Buttons] of Toolbar.  
A list of tool buttons is displayed.

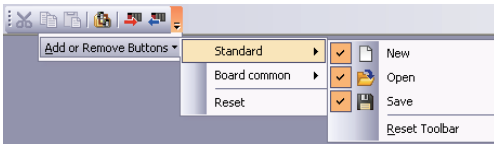

2. Check the check box in front of the tool button to be displayed on the screen.  
The checked tool buttons are displayed on the screen.

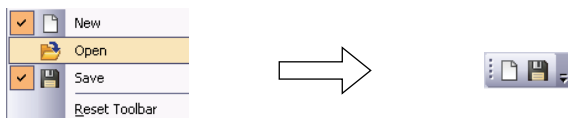

The toolbar configuration returns to the default when [Reset Toolbar] is selected.

## Work windows

A work window is a main screen used for operations such as parameter setting and monitoring in CC IE Field Utility.

### Window

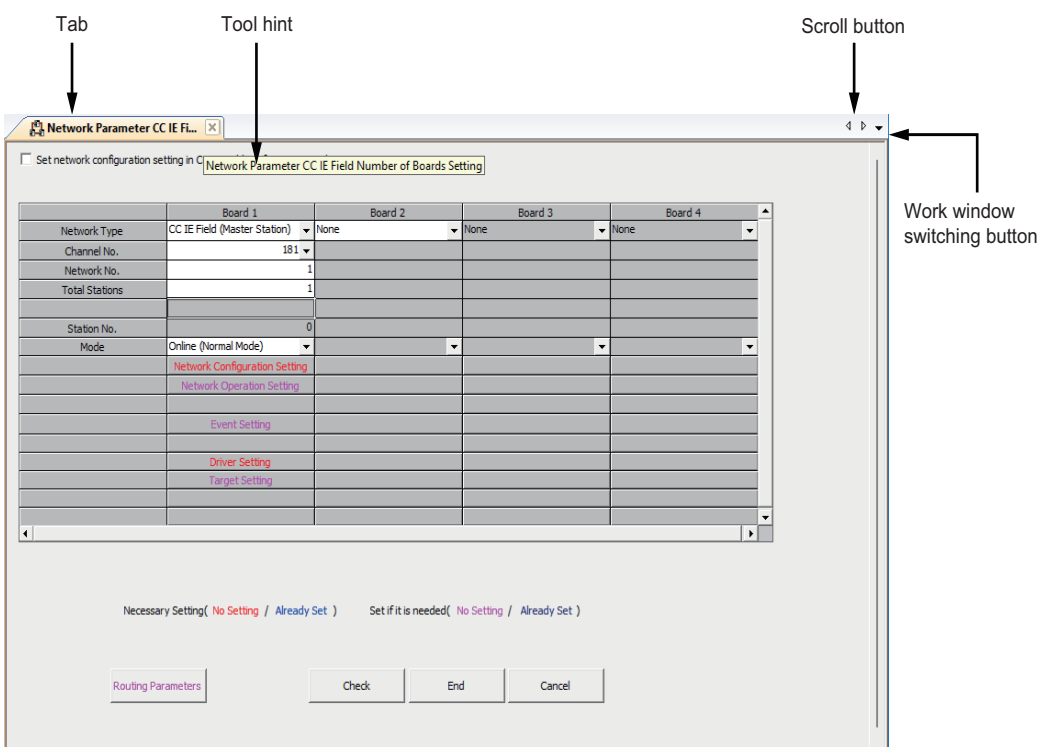

## Displayed items

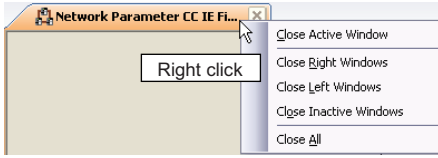
Item	Description
Tab	<p>The tab becomes active when selected.</p> <p>The tab order can be changed by dragging and dropping tabs.</p> <p>The window(s) can be closed from the menu displayed by right-clicking the tab. In addition, the active window can be closed by clicking [×] button on the tab.</p> 
Tool hint	Displays a brief explanation when the cursor is moved onto the selected tab.
Scroll button	<p>Scroll the tab display to the left and right.</p> <p>Displays hidden tabs.</p>
Work window switching button	<p>Displays a list of open windows.</p> <p>Select a data name displayed on the list to display its corresponding window on the top.</p>
Display windows	Display screens such as the "Network Parameter Setting the Number of CC IE Field Cards" screen.

## Arranging/displaying windows

Displays a list of open windows.

And opens and arranges specified windows.

This function is useful to display the desired window efficiently when multiple windows are open.

## Window

 [Window] ⇨ [Window]

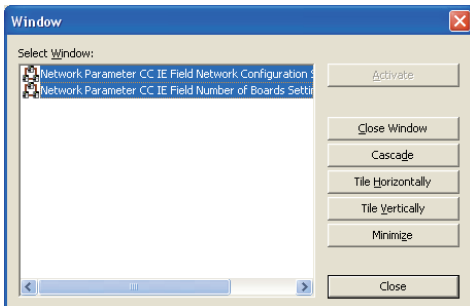

## 8.3 Help Function

### Displaying manuals

Displays the manual of the CC-Link IE Field Network board.

#### Operating procedure

1. Select [Help] ⇒ [Manual]

e-Manual Viewer starts and the manual appears.

### Checking version of CC IE Field Utility

Displays information such as the software version of CC IE Field Utility.

#### Operating procedure

1. Select [Help] ⇒ [About]

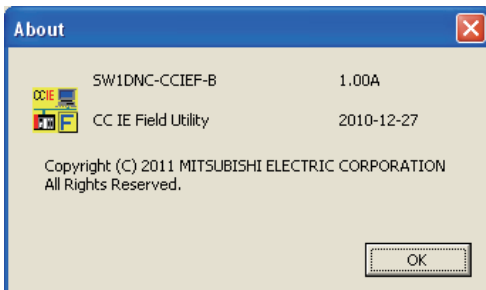

# 9 PROJECT MANAGEMENT

This chapter explains basic operations of CC IE Field Utility such as creating, opening, and saving projects.

## 9.1 Creating Projects

Create a new project.

### Window

 [Project] ⇄ [New]

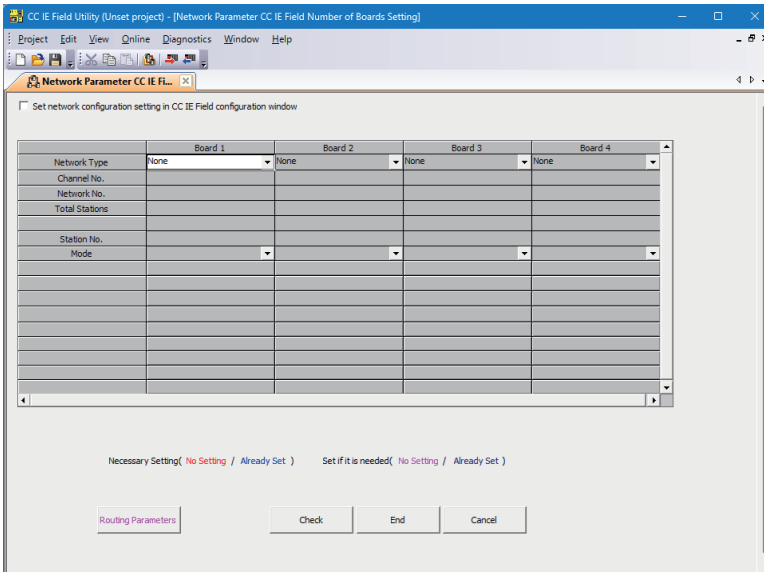

### Point

- Creating a new project with data read from the board  
A new project is created with the data read from the CC-Link IE Field Network board when data are read from the board before creating a new project. ( Page 121 Writing/Reading Parameters to/from Board)
- A note on creating a new project  
Do not change the storage location or file name of created workspace or project folder/file using an application such as Windows Explorer.

# 9.2 Opening Existing Projects

Read a project saved in a hard disk or other memory media of a personal computer.

## Window

 [Project] ⇔ [Open]

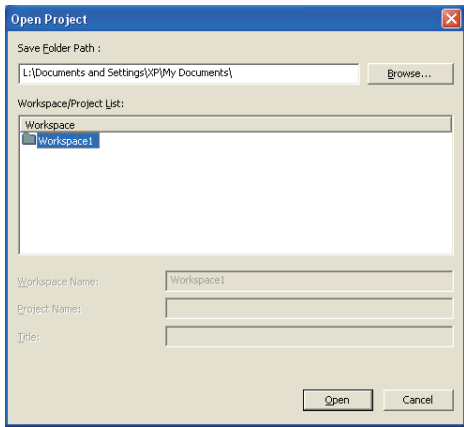

## Operating procedure

1. Set the items in the screen.

Item	Description
Save Folder Path	Enter the folder (drive/path) where the workspace is saved. The folder can be selected in the "Browse For Folder" screen by clicking the [Browse] button.
Workspace/Project List	Select a workspace. The display is switched to the project list by double-clicking "Workspace".
Workspace Name	A selected workspace name is displayed.
Project Name	A selected project name is displayed.
Title	The title of the selected project is displayed.
[Browse] button	Displays the "Browse For Folder" screen.

2. Click the [Open] button.  
The specified project is displayed.

### Point

- **Workspace**  
A workspace is a folder of CC IE Field Utility dedicated to manage multiple projects under the same name. Do not change the workspace configuration using an application such as Windows Explorer.
- **Network drive display in the "Browse For Folder" screen**  
When the network drive display is not displayed, log on to Windows as a user who has an access authority to the assigned folder.

# 9.3 Saving Projects

Save a project in a hard disk or other memory media of a personal computer.

## Saving projects under the specified name

Save the open project under the specified name.

### Window

 [Project] ⇨ [Save As]

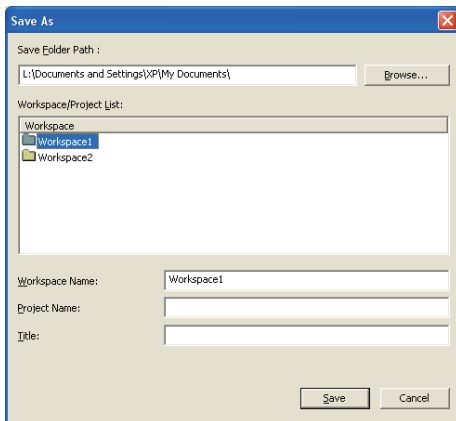

### Operating procedure

1. Set the items in the screen.

Item	Description
Save Folder Path	Enter the folder (drive/path) where the workspace is saved. The folder can be selected in the "Browse For Folder" screen by clicking the [Browse] button.
Workspace/Project List	Select a workspace. The display is switched to the project list by double-clicking "Workspace".
Workspace Name* <sup>1</sup>	Enter the workspace name.
Project Name* <sup>1</sup>	Enter the project name.
Title* <sup>1</sup>	Enter the title of the project.

\*1 Enter each workspace name, project name, and title within 128 characters.

Note, however, that the total number of characters used for the workspace folder path, workspace name, and project name should not exceed 150 characters.

2. Click the [Save] button.

The project is saved in the specified folder under the specified workspace name, project name, and title.

### Point

- **Workspace**  
A workspace is a folder of CC IE Field Utility dedicated to manage multiple projects under the same name. Do not change the workspace configuration using an application such as Windows Explorer.
- **Saving projects in an existing destination**  
When saving a project in an existing destination (workspace or project), the destination folder can be selected from the "Workspace/Project List".
- **Network drive display in the "Browse For Folder" screen**  
When the network drive display is not displayed, log on to Windows as a user who has an access authority to the assigned folder.

## Saving projects

Overwrite and save the project being edited.

### Operating procedure

1. Select [Project] ⇒ [Save]

The existing project data are overwritten.

## 9.4 Saving Projects with Compression and Unpacking Projects

This section explains the methods for saving projects with compression, and unpacking projects saved with compression.

This function gives easier project data passes.

This function is not compatible with commercially available file compression and decompression tools.

### Saving projects with compression

Save a desired project with compression.

#### Window

[Project] ⇒ [Compress/Unpack] ⇒ [Compress]

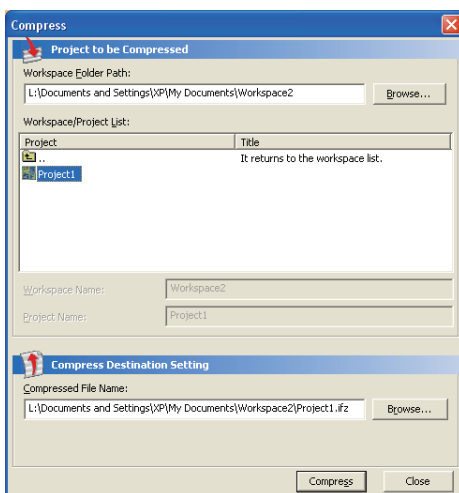

### Operating procedure

1. Set the items in the screen.

Item		Description
Project to be Compressed	Workspace Folder Path	Enter the folder (drive/path) where the workspace is saved. The folder can be selected in the "Browse For Folder" screen by clicking the [Browse] button.
	Workspace/Project List	Select a workspace and a project.
	Workspace Name	A selected workspace name is displayed.
	Project Name	A selected project name is displayed.
Compress Destination Setting	Compressed File Name	Enter the folder where the compressed file is saved and the compressed file name. The compressed file name can be set in the "Compressed File Name" screen by clicking the [Browse] button.

2. Click the [Compress] button.

The compressed project file (\*.ifz) is saved in the specified folder.

## Unpacking projects saved with compression

Unpack a project saved with compression.

### Window

 [Project] ⇒ [Compress/Unpack] ⇒ [Unpack]

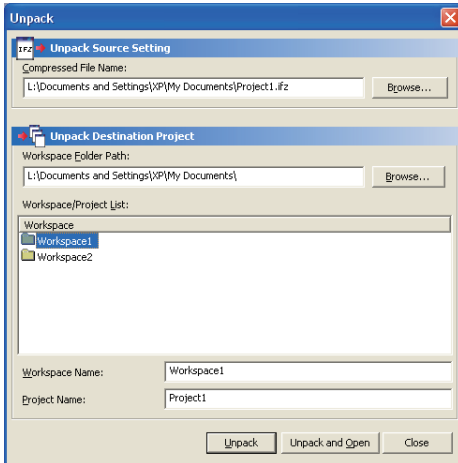

### Operating procedure

1. Set the items in the screen.

Item	Description	
Unpack Source Setting	Compressed File Name	Enter the folder (drive/path) in which the compressed file to be unpacked is saved, and the compressed file name. The compressed file name can be selected in the "Compressed File Name" screen by clicking the [Browse] button.
Unpack Destination Project	Workspace Folder Path	Enter the folder (drive/path) to which the project to be unpacked is saved. The folder can be selected in the "Browse For Folder" screen by clicking the [Browse] button.
	Workspace/Project List	Select a workspace and a project.
	Workspace Name	Enter the name of the workspace to which the unpacked project is saved.
	Project Name	Enter the name of the project to which the unpacked project is saved.
[Unpack and Open] button	Unpacks the compressed project file and opens the project.	

2. Click the [Unpack] button.

The compressed project file is unpacked and saved in the specified folder.

## 9.5 Deleting Projects

This section explains a method for deleting a project saved in a hard disk or other memory media of a personal computer.

### Operating procedure

1. Select [Project] ⇒ [Delete]

The "Delete Project" screen appears.

2. Select the project to be deleted.

3. Click the [Delete] button.

The selected project is deleted.

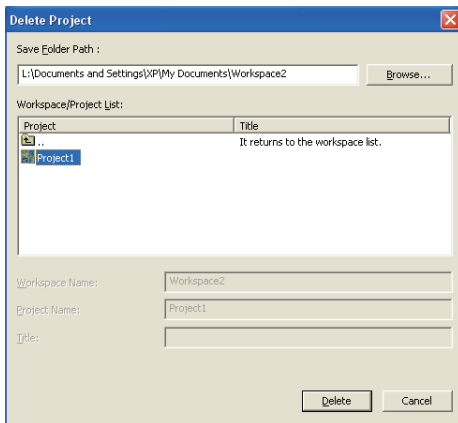

## 9.6 Closing Projects

This section explains a method for closing an open project.

### Operating procedure

1. Select [Project] ⇒ [Close]

# 9.7 Verifying Project Data

This section explains a method for verifying data of an open project and data of another project.

Use this function to check if the data of the projects are the same, or to check the changed parameter locations.

To verify data in the board, perform board verification. (☞ Page 122 Verifying Parameters of Board and Project)

## Window

🔗 [Project] ⇄ [Verify]

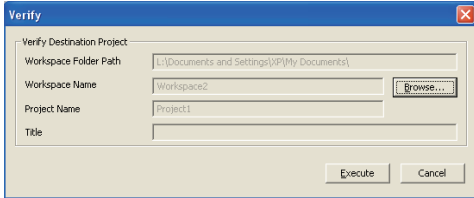

## Operating procedure

1. Click the [Browse] button to set the verify destination project.

Item		Description
Verify Destination Project	Workspace Folder Path	The path to the workspace of a verify destination is displayed.
	Workspace Name	A workspace name is displayed.
	Project Name	The project name of a verify destination is displayed.
	Title	The project title of a target project is displayed.

2. Click the [Execute] button.

The verify result is displayed in the "Verify Result" screen.

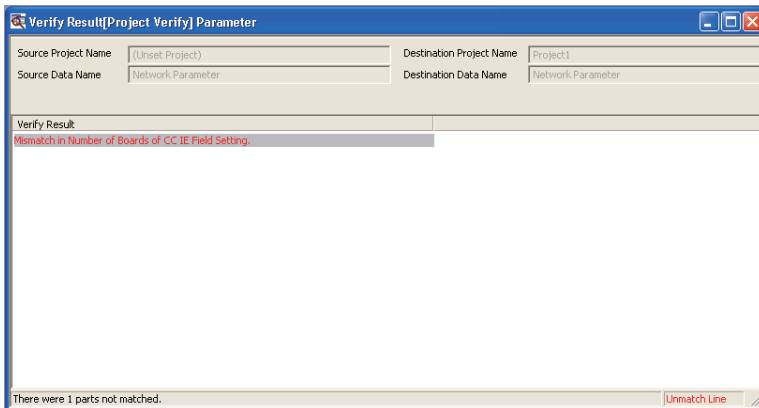

# 10 SETTING PARAMETERS

This chapter explains the parameter setting items and operations in the setting screens in CC IE Field Utility.

For writing set parameters to a board, refer to the following:

☞ Page 121 Writing/Reading Parameters to/from Board

## 10.1 Parameter List

The following table shows the list of CC-Link IE Field Network parameters.

○: Required, △: Set as required, —: No setting

Item	Necessity of setting		Reference	
	Master station	Local stations		
Network setting	Network Type	○	Page 98 Setting Network Parameter	
	Channel No.	○		
	Network No.	○		
	Total Stations	○		—
	Station No.	—		○
	Mode	○		
Network Configuration Setting	Station No.	○	Page 100 Network configuration setting Page 103 CC IE Field configuration setting	
	Station Type	○		
	RX/RX Setting	○		
	RWw/RWr Setting	○		
	Reserved/Error Invalid Station	△		
	Alias	△		
	Comment	△		
	Supplementary Setting	△		
Network Operation Setting	△		Page 112 Network operation setting	
Event Setting	△		Page 112 Event setting	
Driver Setting	○		Page 114 Driver setting	
Target Setting	△		Page 115 Target setting	
Routing Parameters	△		Page 116 Routing parameters	

**Point** 

- When parameters are not set  
CC-Link IE Field Network board operates as a local station (station number 1) of network number 1 in the offline mode. In this case, only transient transmission is performed. (Cyclic transmission is not performed).

# 10.2 Setting Network Parameter

Set the network number, station number, and other parameters for the CC-Link IE Field Network board.

## Window

[View] ⇒ [Network Parameter]

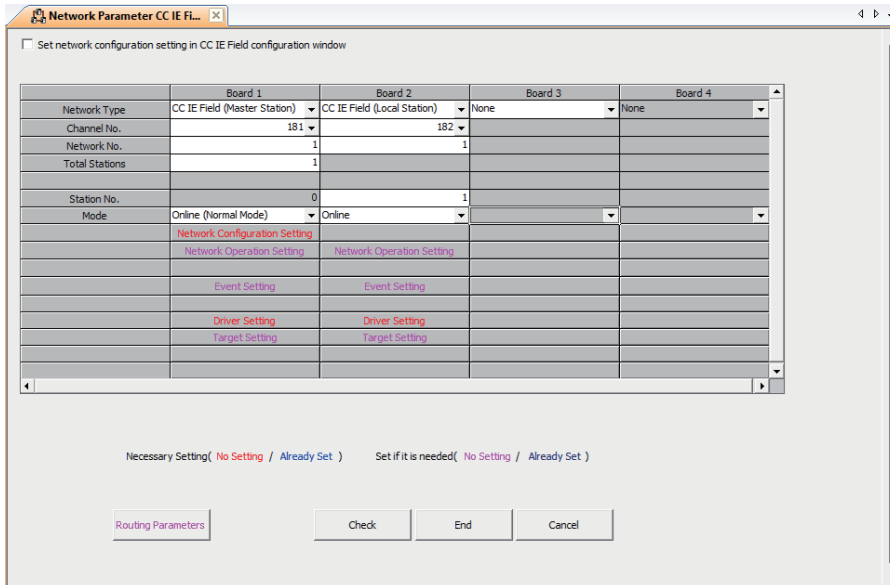

## Operating procedure

1. Set the items in the screen.

Item	Description												
Set network configuration setting in CC IE Field configuration window	Select the checkbox to set a network configuration setting in the CC IE Field configuration window. A network configuration can be set by placing prepared elements in the graphical display.												
Network settings	<table border="1"> <tr> <td>Network Type</td> <td>Select the network type. (☞ Page 99 Network type and mode)</td> </tr> <tr> <td>Channel No.</td> <td>Select the channel number.</td> </tr> <tr> <td>Network No.</td> <td>Set the network number. Setting range: 1 to 239</td> </tr> <tr> <td>Total Stations</td> <td>Set the total number of stations. Setting range: 1 to 120</td> </tr> <tr> <td>Station No.</td> <td>Set the station number of the board. Setting range: Fixed to 0 for a master station, 1 to 120 for a local station</td> </tr> <tr> <td>Mode</td> <td>Select the mode. (☞ Page 99 Network type and mode)</td> </tr> </table>	Network Type	Select the network type. (☞ Page 99 Network type and mode)	Channel No.	Select the channel number.	Network No.	Set the network number. Setting range: 1 to 239	Total Stations	Set the total number of stations. Setting range: 1 to 120	Station No.	Set the station number of the board. Setting range: Fixed to 0 for a master station, 1 to 120 for a local station	Mode	Select the mode. (☞ Page 99 Network type and mode)
Network Type	Select the network type. (☞ Page 99 Network type and mode)												
Channel No.	Select the channel number.												
Network No.	Set the network number. Setting range: 1 to 239												
Total Stations	Set the total number of stations. Setting range: 1 to 120												
Station No.	Set the station number of the board. Setting range: Fixed to 0 for a master station, 1 to 120 for a local station												
Mode	Select the mode. (☞ Page 99 Network type and mode)												
Network configuration settings	<table border="1"> <tr> <td>Network Configuration Setting</td> <td>■When not selecting "Set network configuration setting in CC IE Field configuration window" Display the "Network Configuration Setting" screen. (☞ Page 100 Network configuration setting)</td> </tr> <tr> <td>CC IE Field Configuration Setting</td> <td>■When selecting "Set network configuration setting in CC IE Field configuration window" Display the CC IE Field configuration window. (☞ Page 103 CC IE Field configuration setting)</td> </tr> </table>	Network Configuration Setting	■When not selecting "Set network configuration setting in CC IE Field configuration window" Display the "Network Configuration Setting" screen. (☞ Page 100 Network configuration setting)	CC IE Field Configuration Setting	■When selecting "Set network configuration setting in CC IE Field configuration window" Display the CC IE Field configuration window. (☞ Page 103 CC IE Field configuration setting)								
Network Configuration Setting	■When not selecting "Set network configuration setting in CC IE Field configuration window" Display the "Network Configuration Setting" screen. (☞ Page 100 Network configuration setting)												
CC IE Field Configuration Setting	■When selecting "Set network configuration setting in CC IE Field configuration window" Display the CC IE Field configuration window. (☞ Page 103 CC IE Field configuration setting)												
Network Operation Setting	Display the "Network Operation Setting" screen. (☞ Page 112 Network operation setting)												
Event Setting	Display the "Event Setting" screen. (☞ Page 112 Event setting)												
Driver Setting	Display the "Driver Setting" screen. (☞ Page 114 Driver setting)												
Target Setting	Display the "Target Setting" screen. (☞ Page 115 Target setting)												
[Routing Parameters] button	Displays the "CC IE Field Routing Information Setting" screen. (☞ Page 116 Routing parameters)												
[Check] button	Checks whether the settings are correct.												

2. Click the [End] button.

# Network type and mode

The following explains network types and modes of parameter.

## Network type

The following types can be selected.

Item	Description
CC IE Field (Master Station)	Use as a master station in the CC-Link IE Field Network.
CC IE Field (Local Station)	Use as a local station in the CC-Link IE Field Network.

## Mode

Selectable items for the mode are different depending on the network type.

### ■ Master station

The following modes can be selected.

Item	Description
Online (Normal Mode)	This mode performs cyclic transmission and transient transmission without losing their inherent speed performance. This mode is suitable for a system that performs I/O control and analog control, and transmits large amount of data for management, monitoring, and diagnostics by transient transmission. Use this mode for general applications.
Online (High Speed Mode)	This mode preferentially performs cyclic transmission for high-speed communications. This mode is suitable for a system to achieve I/O control, analog control, and digital I/O at high speed. Note that the maximum points assigned to RWw/RWr is 256 points per local station. In this mode, the processing speed of transient transmission is slower than that in "Online (Normal Mode)".
Offline	Select this mode to disconnect the station from the network for stopping data link with other stations.

For the differences in cyclic transmission between "Online (Normal Mode)" and "Online (High Speed Mode)", refer to the following:

 Page 228 Differences in Cyclic Transmission Modes

### ■ Local stations

The following modes can be selected.

Item	Description
Online	Select this mode to connect the station to the network for performing data link with other stations.
Offline	Select this mode to disconnect the station from the network for stopping data link with other stations.

# Network configuration setting

Set parameters of device stations (device station points, link device assignment) to the master station, and set link scan mode and block data assurance per station.

This setting is available when "CC IE Field (Master Station)" is selected in the network setting.

## Point

A network configuration setting can be displayed when not selecting the checkbox of "Set network configuration setting in CC IE Field configuration window" in the "CC IE Field Number of Boards Setting" screen.

When using the CC IE Field configuration window, refer to the following:

Page 103 CC IE Field configuration setting

## Window

[View] ⇒ [Network Parameter] ⇒ "CC IE Field Number of Boards Setting" screen ⇒ "Network Configuration Setting"

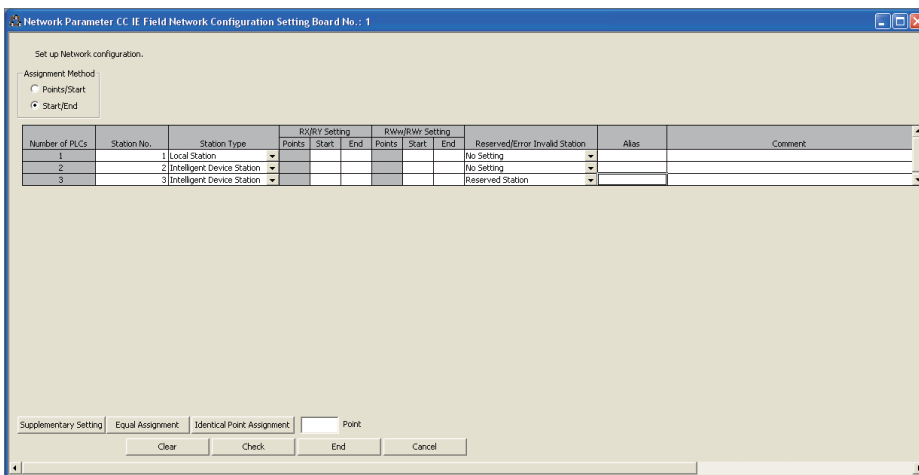

## Operating procedure

1. Set the items in the screen.

Item	Description	
Assignment Method	Select an assignment method for send range of each station.	
Number of PLCs	Display the number of stations from 1 to total stations.	
Station No.	Set the station number. Setting range: 1 to 120	
Station Type	Select the station type.	
RX/Ry Setting	Points	Specify the number of relay points on the link side. Setting range: • 16 to 2048 points for "Local Station" and "Intelligent Device Station" • 16 to 128 points for "Remote Device Station", 16 to 64 points for "Remote I/O Station"
	Start	Specify the start point of relay on the link side. Setting range: 0 to 3FFF
	End	Specify the end point of relay on the link side. Setting range: F to 3FFF
RWw/RWr Setting	Points	Specify the number of registers on the link side. Setting range: • 4 to 1024 points for "Local Station" and "Intelligent Device Station" • 4 to 64 points for "Remote Device Station"
	Start	Specify the start point of register on the link side. Setting range: 0 to 1FFF
	End	Specify the end point of register on the link side. Setting range: 3 to 1FFF
Reserved/Error Invalid Station	Set reserved stations and error invalid stations.	

Item	Description
Alias	Set the alias. Setting range: Up to 8 characters
Comment	Set the comment. Setting range: Up to 32 characters
[Supplementary Setting] button	Displays the "Supplementary Setting" screen. (☞ Page 101 Supplementary setting)
[Equal Assignment] button	Displays the "Equal Assignment" screen. (☞ Page 102 Equal assignment)
[Identical Point Assignment] button	Assigns the same link device points to all local stations. Enter the points in the field next to the button.
[Clear] button	Clears all settings.
[Check] button	Checks whether the settings are correct.

2. Click the [End] button.

## Supplementary setting

Set the link scan mode, loopback function, and block data assurance per station.

### Window

☞ [View] ⇒ [Network Parameter] ⇒ "CC IE Field Number of Boards Setting" screen ⇒ "Network Configuration Setting" ⇒ "Network Configuration Setting" screen ⇒ [Supplementary Setting] button

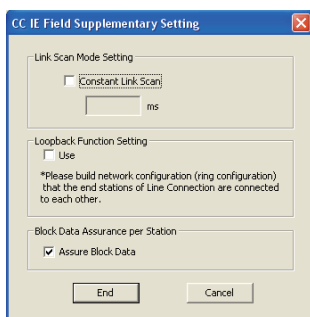

### Operating procedure

1. Set the items in the screen.

Item	Description
Link Scan Mode Setting*1 Constant Link Scan	Set this item to perform cyclic transmission at constant intervals. Link scan will be performed by the interval set in this item. Check the check box and set the constant link scan time. Setting range: 1 to 200
Loopback Function Setting	Select whether to use the loopback function. (☞ Page 76 Loopback Function) To configure a network in ring topology, select this check box.
Block Data Assurance per Station	Select whether to assure data integrity on a station basis in link refresh between the driver and the board.

\*1 Link scan is executed 'asynchronously' with the link refresh which is executed by the CC-Link IE Field Network board driver.

2. Click the [End] button.

### ■Link scan mode setting

The constant link scan can be set by checking the check box.

Set this item to perform cyclic transmission at constant intervals. Link scan will be performed by the interval set in this item.

However, when the actual link scan time is longer than constant link scan time, cyclic transmission is performed by link scan time. While constant link scan is used to keep link scan time constant, the transmission delay time is not kept constant by this function.

Set constant link scan in increments of 1ms.

## Equal assignment

Equally assign link devices to local stations with preset conditions.

### Window

[View] ⇒ [Network Parameter] ⇒ "CC IE Field Number of Boards Setting" screen ⇒ "Network Configuration Setting" ⇒ "Network Configuration Setting" screen ⇒ [Equal Assignment] button

### Operating procedure

1. Set the items in the screen.

Item		Description
RX/Ry Equal Assignment	Start Station	Set the start station number of local stations for which link devices are equally assigned. Setting range: 1 to the end device station number
	End Station	Set the end station number of local stations for which link devices are equally assigned. Setting range: Start station number to the end device station number
	Start No.	Set the start number of link devices to be equally assigned. Setting range: 0 to 3FF0
	Total Points Assigned	Set the total points of link devices to be equally assigned. Setting range: 16 to (16384 - start number)
RWw/RWr Equal Assignment	Start Station	Set the start station number of local stations for which link devices are equally assigned. Setting range: 1 to the end device station number
	End Station	Set the end station number of local stations for which link devices are equally assigned. Setting range: Start station number to the end device station number
	Start No.	Set the start number of link devices to be equally assigned. Setting range: 0 to 1FFC
	Total Points Assigned	Set the total points of link devices to be equally assigned. Setting range: 4 to (8192 - start number)

2. Click the [OK] button.

# CC IE Field configuration setting

By placing prepared elements in the graphical display, set parameters of device stations (device station points, link device assignment) to the master station, and set link scan mode and block data assurance per station. This setting is available when "CC IE Field (Master Station)" is selected in the network setting.

**Point**

Select the checkbox of "Set network configuration setting in CC IE Field configuration window" in the "CC IE Field Number of Boards Setting" screen before setting channel numbers and network numbers.

## Window

[View] ⇒ [Network Parameter] ⇒ "CC IE Field Number of Boards Setting" screen ⇒ "CC IE Field Configuration Setting"

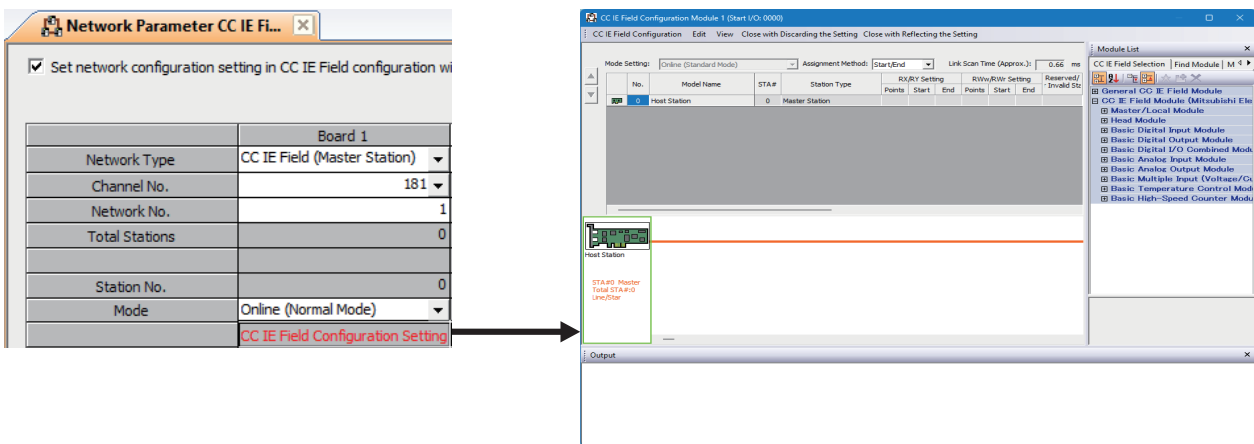

## Operating procedure

1. Select a module in the module list window, then drag and drop it onto the station list (1) or device configuration diagram (2).

A device station is added in the station list.

In addition, the added module is displayed on the device configuration diagram.

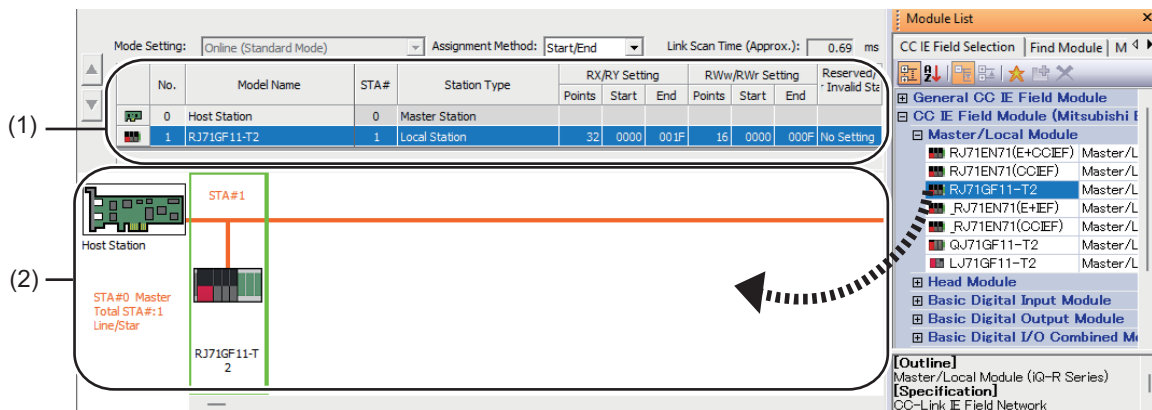

- (1) Station list
- (2) Device configuration diagram

"Object Name" of the property screen is displayed for each device on the device configuration diagram. (Page 105 Displaying the object name)

**Point**

When setting a CC-Link IE Field Network board as a local station, place a general CC IE Field module (general local station).

**2.** Set each item.

Page 104 Setting items

**3.** Check the system configuration.

[CC IE Field Configuration] ⇒ [Check] ⇒ [System Configuration]

The system configuration of CC-Link IE Field Network is checked.

Check the result of system configuration check in the output window.

If an error or warning appears in the output window, refer to the following:

MELSOFT Navigator MessageNo.

**4.** Select [Close with Reflecting the Setting] and close the CC IE Field configuration window.

## Setting items

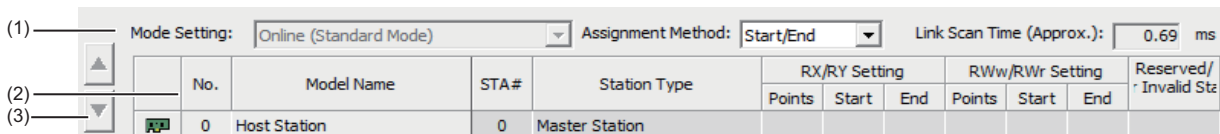

No.	Item	Description
(1)	Mode Setting	The mode of the master station is displayed.
	Assignment Method	Select a link device assignment method. <ul style="list-style-type: none"> <li>• Points/Start: Enter the numbers of points and start numbers of link devices.</li> <li>• Start/End: Enter the start and end numbers of link devices.</li> </ul>
	Link Scan Time (Approx.)	The approximate value for the link scan time is displayed. For details, refer to the following: Page 227 Link scan time
(2)	Station list	Set parameters for a device station. Page 104 Station list
(3)	Row move buttons	Click these to move the order of a target station selected in the station list. Even if the position of a module is changed, the station number is not changed.

### ■ Station list

Setting item (detailed display)	Description
No.	'0' is displayed for the master station, and 'the number indicating the position among device stations' is displayed for a device station.
Object Name	When selecting [View] ⇒ [Object Name Display], the object name of a device is displayed.
Model Name	The module model name is displayed.
STA#	Set the station number of a device station connected to a network. Station numbers do not need to be set consecutively, but must be unique. Setting range: Fixed to 0 for a master station, 1 to 120 for a local station
Station Type	Set the station types. Select the station types same as those of the modules connected to the network.
RX/Ry Setting	Assign RX/Ry points in increments of 16. Setting range: <ul style="list-style-type: none"> <li>• Number of points: 16 to 16384</li> <li>• Start: 0H to 3FF0H</li> <li>• End: FH to 3FFFH</li> </ul>
RWw/RWr Setting	Assign RWw/RWr points in increments of 4. Setting range: <ul style="list-style-type: none"> <li>• Number of points: 4 to 8192</li> <li>• Start: 0H to 1FFCH</li> <li>• End: 3H to 1FFFH</li> </ul>
Reserved/Error Invalid Station	Set the device station as a reserved station or error invalid station. <ul style="list-style-type: none"> <li>• No Setting: The device station is connected to the network.</li> <li>• Reserved Station: The device station is reserved for future expansion. By using a reserved station, link device assignment will not change even if the device station is added (reservation is canceled). Therefore, modification of the program is not required. Physical connection of the device station on the network is not required.</li> <li>• Error Invalid Station: Even if a device station is disconnected during data link, the master station will not detect the device station as a faulty station.</li> </ul>

Setting item (detailed display)	Description	
Station Information	Alias	Enter the name of a device if required. Setting range: Up to 32 characters
	Comment	Information entered in "Comment1" in the "Properties" screen displayed by right-clicking a module and selecting [Properties] in the station list or the device configuration diagram is displayed. Setting range: Up to 32 characters
	Station-specific mode setting	Set the station-specific mode of a device station. This setting is available when the device station supports the station-specific mode.

## Displaying the transmission path method

The transmission path method can be checked on the device configuration diagram.

- Double line: Ring
- Single line: Line/Star

### ■ Changing the transmission path method

The transmission path method can be changed by following the procedure:

1. Select [CC IE Field Configuration] ⇒ [Change Transmission Path Method].

#### Point

"Change Transmission Path Method" and "Loopback Function Setting" that can be set in the "CC IE Field Supplementary Setting" screen are linked.

- When selecting "Line/Star," "Loopback Function Setting" will not be used.
- When selecting "Ring," "Loopback Function Setting" will be used.

## Displaying the object name

The object name of a module displayed in the station list in the CC IE Field configuration window is displayed.

[View] ⇒ [Object Name Display]

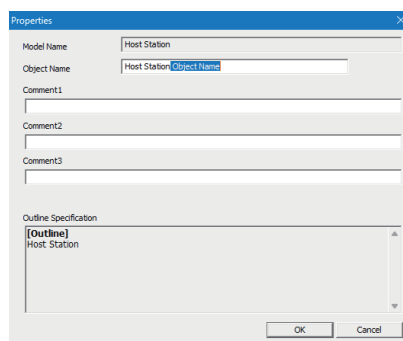
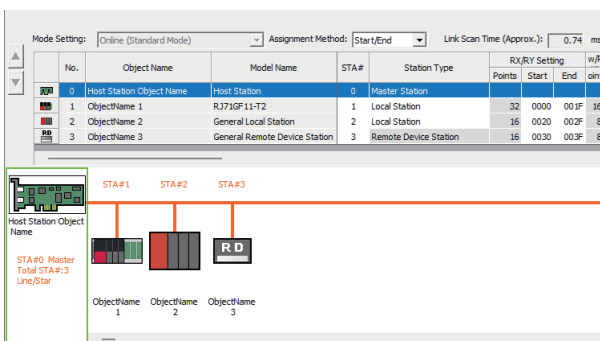

### ■ Changing the object name

Change the object name.

By changing object names to any ones, each module can easily be identified in the CC IE Field configuration window.

1. On the device configuration diagram in the CC IE Field configuration window, right-click a module for changing its object name and click "Properties."
2. Change "Object Name."
3. Click the [OK] button.

## Properties

The object name, comment, etc. can be set for each module.

The image diagram can be changed using "Properties" for the particular selected module. Right-click and select [Properties] from the shortcut menu.

Configuration applications, setting files, and manuals can be linked to the modules. Double-click the added module to open the linked application or file.

## Docked window

The docked window is a window that can be switched between the docked display and the floating display.

- Docked display: Drag the title bar of a floating dockable window and drop it to the displayed icon (guidance) to dock the main frame.
- Floating display: Drag the title bar of a docked window and drop it to the arbitrary position to make the window floated from the main frame.

Whether to show or hide the window can be switched by selecting [View] ⇒ [Docking Window] ⇒ [(target item)].

## Module list window

Modules that can be placed on the device configuration diagram are displayed. (☞ Page 108 Module list)

The following functions can be used by switching the tab.

Tab name	Description
CC IE Field Selection	Modules that can be placed on the device configuration diagram are displayed. (☞ Page 108 Module list) The following operations can be performed from the shortcut menu or with buttons of the toolbar: <ul style="list-style-type: none"><li>• [Display by Category]/[Display in Alphabetic Order]: To switch the display format.</li><li>• [Open Layer]/[Close Layer]: To open/close a layer for the display by category.</li><li>• [Register in My Favorites]: To add a module frequently used to the [My Favorites] tab by setting a folder.</li></ul>
Find Module	A module can be searched for by specifying a category or character string. The following operation can be performed from the shortcut menu or with buttons of the toolbar: <ul style="list-style-type: none"><li>• [Register in My Favorites]: To add a searched module to the [My Favorites] tab by setting a folder.</li></ul>
My Favorites	A module registered as a favorite in another tab is displayed. Modules can be organized using folders with layers. The layer display can be changed or a folder can be edited from the shortcut menu or with buttons of the toolbar. <ul style="list-style-type: none"><li>• [Open Layer]/[Close Layer]: To open/close a layer.</li><li>• [Folder Creation]/[Change Folder Name]/[Delete]: To edit a folder.</li></ul>

The detailed information of a module selected in each tab is displayed at the bottom of the module list window.

## Output window

Check results of system configuration are displayed.

## Menu list

The following table shows the menus used when displaying the CC IE Field configuration window.

Item		Description	Reference	
CC IE Field Configuration	Change Module	Replace General CC IE Field Module	Replace a general CC IE Field module with a specific module.	Page 109 Replacing a general CC IE Field module
		Change to General CC IE Field Module	Change a specific module to a general CC IE Field module.	Page 109 Changing to a general CC IE Field module
	Change Transmission Path Method	Line/Star	Change the transmission path method to "Line/Star."	Page 105 Changing the transmission path method
		Ring	Change the transmission path method to "Ring."	
	Supplementary Setting		Set "Link Scan Mode Setting," "Loopback Function Setting," and "Block Data Assurance per Station."	Page 110 Supplementary setting
	Equal Assignment		Equally assign the link device points with preset conditions.	Page 110 Equal assignment
	Identical Point Assignment		Assign link devices with the identical number of points according to the set total number of stations.	Page 111 Identical point assignment
	Device No. Reassignment		Assign the device numbers consecutively to the link devices of a specified target station.	Page 111 Device number reassignment
	Check	System Configuration	Check whether the device configuration of set CC-Link IE Field Network is correct.	—
	Online	Parameter Processing of Device Station	Execute parameter processing or commands for a device station.	Manual for the device station used
		Command Execution of Device Station	This can only be executed if the device station supports parameter processing and command execution. Setting ranges differ depending on target modules.	
	Close with Discarding the Setting		Discard the setting and close the CC IE Field configuration window.	—
	Close with Reflecting the Setting		Reflect the setting and close the CC IE Field configuration window.	—
Edit	Copy		Copy the information of a device station in the selected row. The copied information can also be pasted in another application such as a text editor.	—
	Paste		Paste a copied device station to the last row of the station list.	
	Select All		Select all stations in the station list.	
	Delete		Delete a device station in the selected row.	
View	Docking Window	Module List	Display/hide each window.	Page 106 Docked window
		Output		
	Object Name Display		Display/hide object names in the station list.	Page 105 Displaying the object name
Close with Discarding the Setting		Discard the setting and close the CC IE Field configuration window.	—	
Close with Reflecting the Setting		Reflect the setting and close the CC IE Field configuration window.	—	

## Module list

The following table shows the modules whose model names are displayed in the module list in CC IE Field Utility. For a module not described in the table, place a general CC IE Field module.

Board/module	Station type	Model name
Master/local module	Local station	RJ71EN71 <sup>*1</sup> RJ71GF11-T2 QJ71GF11-T2 LJ71GF11-T2
Head module	Intelligent device station	LJ72GF15-T2
Basic digital input module	Remote device station	NZ2GF12A4-16D NZ2GF12A4-16DE NZ2GF2B1-16D NZ2GF2B2-16A NZ2GF2S1-16D NZ2GF2S2-16A NZ2GFCE3-16D NZ2GFCE3-16DE NZ2GFCM1-16D NZ2GFCM1-16DE NZ2GFCE3-32D
	Intelligent device station	NZ2GF2B1-32D NZ2GFCF1-32D
Basic digital output module	Remote device station	NZ2GF12A2-16T NZ2GF12A2-16TE NZ2GF2B1-16T NZ2GF2B1-16TE NZ2GF2B2-16R NZ2GF2B2-16S NZ2GF2S1-16T NZ2GF2S1-16TE NZ2GF2S2-16R NZ2GF2S2-16S NZ2GFCE3-16T NZ2GFCE3-16TE NZ2GFCM1-16T NZ2GFCM1-16TE NZ2GFCE3-32T
	Intelligent device station	NZ2GF2B1-32T NZ2GF2B1-32TE NZ2GFCF1-32T
Basic digital I/O combined module	Remote device station	NZ2GF12A42-16DT NZ2GF12A42-16DTE NZ2GFCE3-32DT
	Intelligent device station	NZ2GF2B1-32DT NZ2GF2B1-32DTE NZ2GFCF1-32DT
Basic analog input module	Remote device station	NZ2GF2B-60AD4 NZ2GFCE-60ADI8 NZ2GFCE-60ADV8
Basic analog output module	Remote device station	NZ2GF2B-60DA4 NZ2GFCE-60DAI8 NZ2GFCE-60DAV8
Basic multiple input (voltage/current/temperature) module	Remote device station	NZ2GF2S-60MD4
Basic temperature control module	Remote device station	NZ2GF2B-60TCRT4 NZ2GF2B-60TCTT4
Basic high-speed counter module	Remote device station	NZ2GFCF-D62PD2

\*1 The displayed name in parentheses indicates an abbreviation for the network type that can be used for Ethernet ports (P1 and P2). When using a CPU module with a built-in port that supports CC-Link IE Field Network, select a model name with '\_' (underscore). The display of model names in the screen is compliant with GX Works3. For combinations of model names to be set and the available networks, refer to the following:

 MELSEC iQ-R Ethernet/CC-Link IE User's Manual (Startup)

## Changing a module

The following shows the method for replacing a general CC IE Field module with a device station and vice versa.

### ■Replacing a general CC IE Field module

Replace a general CC IE Field module with a specific module.

1. Select a general CC IE Field module to be replaced in the station list in the CC IE Field configuration window.
2. Select [CC IE Field Configuration] ⇒ [Change Module] ⇒ [Replace General CC IE Field Module].

The "Replace General CC IE Field Module" screen appears.

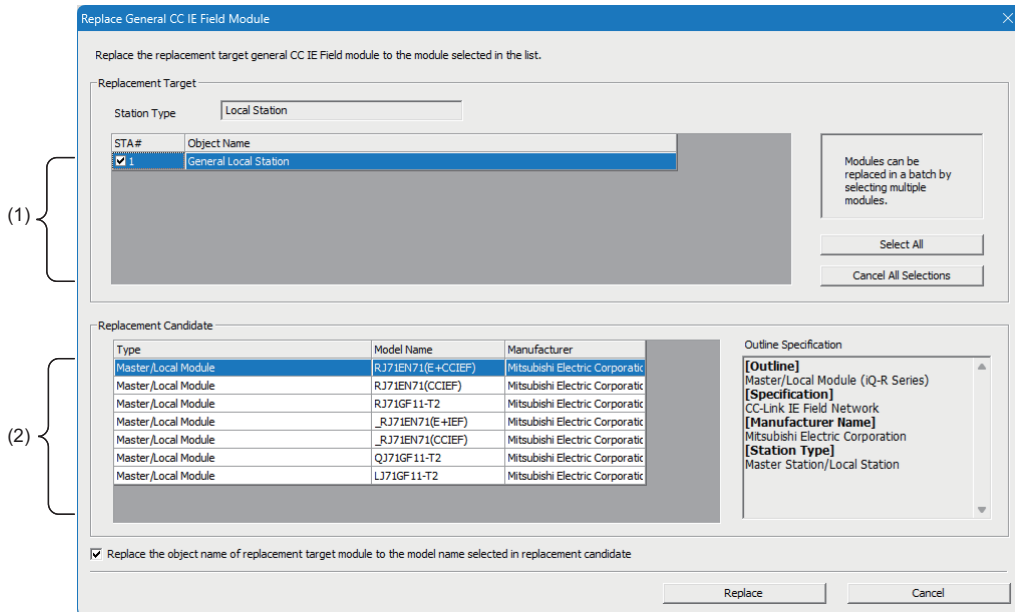

Item	Description	
Replacement Target	Station Type	Displays the station type of a module selected in the CC IE Field configuration window.
	(1) Replacement target list	General CC IE Field modules with the station type same as the general CC IE Field modules selected in the station list are displayed. By selecting the checkboxes, multiple general CC IE Field modules can be replaced.
	[Select All] button	Click this to select all checkboxes in the replacement target list.
	[Cancel All Selections] button	Click this to unselect all checkboxes in the replacement target list.
Replacement Candidate	(2) Replacement candidate list	The modules to be replaced are displayed.
	Outline Specification	The outline specifications of the module selected in the replacement candidate list are displayed.
	Replace the object name of replacement target module to the model name selected in replacement candidate	Select the checkbox when replacing the object name of a replacement target module with the model name of a module selected in the replacement candidate.

3. Click the [Replace] button.

A module selected in the replacement target list is replaced with a module selected in the replacement candidate list.

### ■Changing to a general CC IE Field module

Change a module of the device station to a general CC IE Field module with the same station type.

1. Select a module to be replaced in the station list in the CC IE Field configuration window.
2. Select [CC IE Field Configuration] ⇒ [Change Module] ⇒ [Change to General CC IE Field Module].

It is replaced with a general CC IE Field module supported by the module.

## Supplementary setting

Set settings for the link scan mode, loopback function, and block data assurance per station.

### Window

 [CC IE Field Configuration] ⇒ [Supplementary Setting]

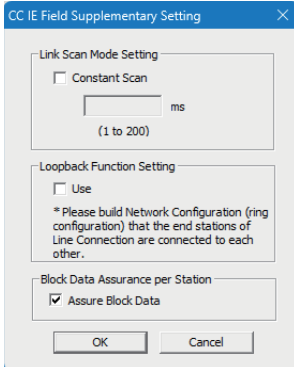

For details on the settings, refer to the following:

 Page 101 Supplementary setting

### Point

"Change Transmission Path Method" and "Loopback Function Setting" that can be set in the "CC IE Field Supplementary Setting" screen are linked.

- When selecting "Line/Star," "Loopback Function Setting" will not be used.
- When selecting "Ring," "Loopback Function Setting" will be used.

## Equal assignment

Equally assign the link device points with preset conditions.

### Window

 [CC IE Field Configuration] ⇒ [Equal Assignment]

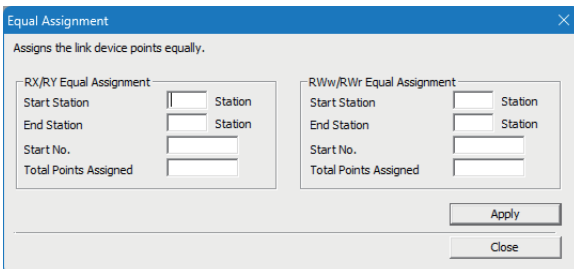

### Operating procedure

1. Set the items in the screen.

Item		Description
RX/Ry Equal Assignment	Start Station	Set the start station number to be equally assigned.
	End Station	Set the end station number to be equally assigned.
RWw/RWr Equal Assignment	Start No.	Set the start number of link devices to be equally assigned.
	Total Points Assigned	Set the total points of link devices to be equally assigned.

2. Click the [Apply] button.

Link devices are equally assigned to the stations within the setting range.

## Identical point assignment

Assign link devices with the identical number of points according to the set total number of stations.

### Window

 [CC IE Field Configuration] ⇒ [Identical Point Assignment]

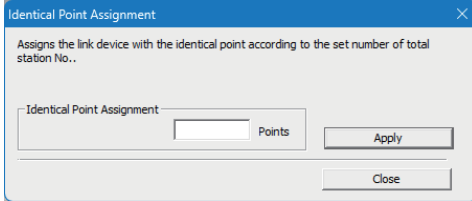

### Operating procedure

1. Enter the number of points to be assigned.
2. Click the [Apply] button.

The identical number of points is assigned to each station.

## Device number reassignment

Assign the device numbers consecutively to the link devices of a specified target station.

For the number of link device points, the number of points assigned in the station list in the CC IE Field configuration window is used.

### Window

 [CC IE Field Configuration] ⇒ [Device No. Reassignment]

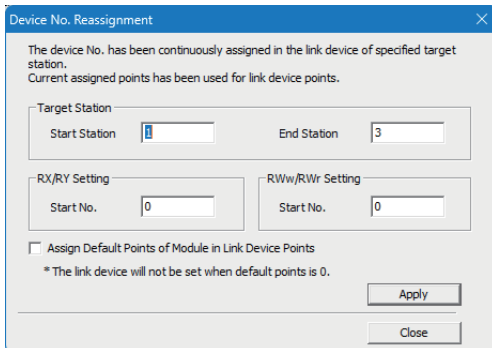

### Operating procedure

1. Set the items in the screen.

Item		Description
Target Station	Start Station	Set the start station for assignment.
	End Station	Set the end station for assignment.
RX/Ry Setting	Start No.	Set the start device number of RX/Ry for assignment.
RWw/RWr Setting	Start No.	Set the start device number of RWw/RWr for assignment.

2. Click the [Apply] button.

Device numbers are assigned consecutively to the stations within the setting range.

### Point

When selecting the checkbox of "Assign Default Points of Module in Link Device Points" and clicking the [Apply] button, the default points of each module are reassigned.

However, if a default number of points is 0, the number of points of corresponding link device is not assigned.

# Network operation setting

Set the parameter name and network operation at data link error.

## Window

[View] ⇒ [Network Parameter] ⇒ "CC IE Field Number of Boards Setting" screen ⇒ "Network Operation Setting"

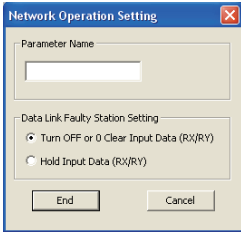

## Operating procedure

1. Set the items in the screen.

Item	Description
Parameter Name	Set the parameter name of the "Network Operation Setting". Setting range: Up to 8 characters
Data Link Faulty Station Setting	Select whether to hold or clear data input from the device station where a data link error has occurred.

2. Click the [End] button.

# Event setting

Set conditions to notify events to a user program.

## Window

[View] ⇒ [Network Parameter] ⇒ "CC IE Field Number of Boards Setting" screen ⇒ "Event Setting"

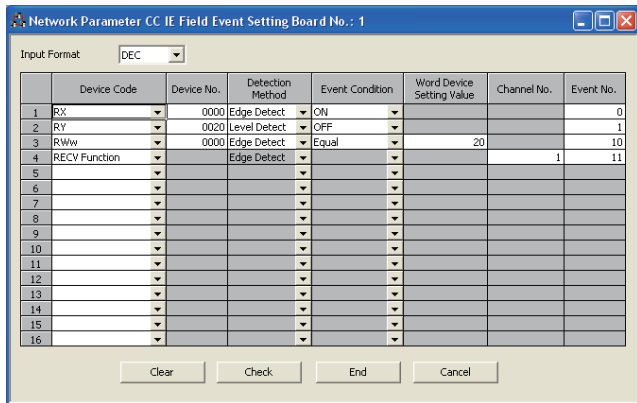

## Operating procedure

1. Set the items in the screen.

Item	Description
Input Format	Set the format of the setting value.
Device Code <sup>1</sup>	Set the link device name for the event condition.
Device No.	Set the link device number for the event condition. Setting range: For link devices RX and RY: 0 to 3FFF For link devices SB and SW: 0 to 01FF For link devices RWw and RWr: 0 to 1FFF
Detection Method	Set the detection method. (Page 113 Combination of detection method and event condition)

Item	Description
Event Condition	Set the event condition. (☞ Page 113 Combination of detection method and event condition)
Word Device Setting Value	Set the word device setting value. DEC setting range: 0 to 65535 HEX setting range: 0000 to FFFF
Channel No.	Set the channel number (use for dedicated instructions) . Setting range: 1 to 2
Event No.	Set the event number. Setting range: 0 to 15
[Clear] button	Clears all settings.
[Check] button	Checks whether the settings are correct.

\*1 When selecting "RECV Function", set "No Setting" for "RECV Function Reception Buffer" in the driver setting.

2. Click the [End] button.

### Combination of detection method and event condition

The following table shows results and events of the combination of detection method and event condition.

Device	Detection Method	Event Condition	Description
RX RY SB	Edge Detect	ON	An event occurs at the rising edge of the device.
		OFF	An event occurs at the falling edge of the device.
	Level Detect	ON	An event occurs by turning ON the device.
		OFF	An event occurs by turning OFF the device.
RWw RWr SW	Edge Detect	Equal	An event occurs when values match. (First time only)
		Unequal	An event occurs when values do not match. (First time only)
		Change	An event occurs when values change. (First time only)
	Level Detect	Equal	An event occurs when values match.
		Unequal	An event occurs when values do not match.
RECV Function	Edge Detect	—	An event occurs when a specified channel receives data.

# Driver setting

Set the driver WDT monitoring time, transient timeout monitoring time, link refresh cycle, and RECV function reception buffer.

## Window

[View] ⇒ [Network Parameter] ⇒ "CC IE Field Number of Boards Setting" screen ⇒ "Driver Setting"

The screenshot shows a dialog box titled "Driver Setting" with the following fields and controls:

- Driver WDT Monitoring Time:** A checkbox labeled "Use driver WDT function" is checked. Below it is a text input field containing "200" followed by a multiplier "x10ms".
- RECV Function Receive Buffer:** Two radio buttons are present: "No Setting" (which is selected) and "Setting".
- Transient Timeout Monitoring Time:** A text input field containing "15" followed by a multiplier "s".
- Link Refresh Cycle:** A text input field containing "1" followed by a multiplier "ms".
- Buttons:** "End" and "Cancel" buttons are located at the bottom right of the dialog.

## Operating procedure

1. Set the items in the screen.

Item	Description
Driver WDT Monitoring Time	Select "Use driver WDT function" to enable the function. Set the driver WDT monitoring time. Setting range: 1 to 32767
Transient Timeout Monitoring Time	Set the transient timeout monitoring time. Setting range: 1 to 360
Link Refresh Cycle	Set the link refresh cycle. Setting range: 1 to 1000
RECV Function Reception Buffer*1	Set the RECV function reception buffer.

\*1 Set "No Setting" when "RECV Function" is selected for the device code in the event setting.

2. Click the [End] button.

# Target setting

Set logical station numbers to access to multiple CPU system or redundant CPU system using the MELSEC data link library function.

## Window

[View] ⇒ [Network Parameter] ⇒ "CC IE Field Number of Boards Setting" screen ⇒ "Target Setting"

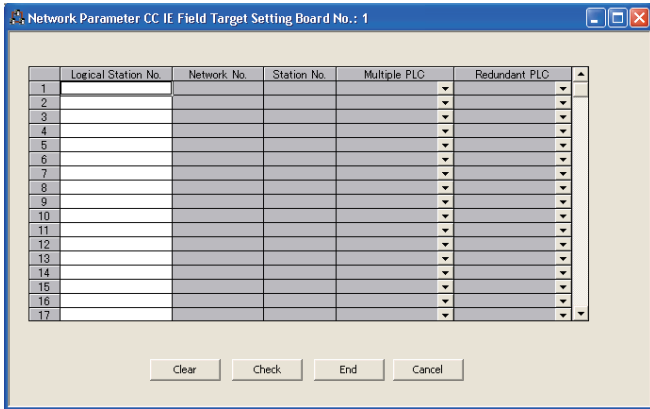

## Operating procedure

1. Set the items in the screen.

Item	Description
Logical Station No.	Set the logical station number. Setting range: 0 to 239
Network No.	Set the network number of the access target. Setting range: 1 to 239
Station No.	Set the station number of the access target. Setting range: 0 to 120
Multiple PLC	Set the access target CPU (CPU number in the multiple CPU system).
Redundant PLC	Set the access target CPU (system specification for the redundant system).
[Clear] button	Clears all settings.
[Check] button	Checks whether the settings are correct.

2. Click the [End] button.

# Routing parameters

Set communication paths for transient transmission between a station in the own network and stations in other networks.

## Window

[View] ⇒ [Network Parameter] ⇒ "CC IE Field Number of Boards Setting" screen ⇒ [Routing Parameters] button

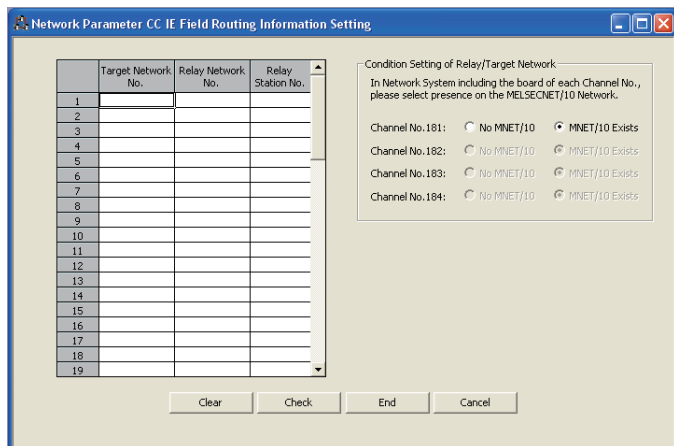

## Operating procedure

1. Set the items in the screen.

Item	Description
Target Network No.	Set the target network number. Numbers cannot be overlapped. Setting range: 1 to 239
Relay Network No.	Set the first relay network number in the path to the target network. Setting range: 1 to 239
Relay Station No.	Set the first relay station number in the path to the target network. Setting range: 0 to 120
Condition Setting of Relay/Target Network	Set whether MELSECNET/10 network is to be used for routing the network.
[Clear] button	Clears all settings.
[Check] button	Checks whether the settings are correct.

2. Click the [End] button.

## Target relay network

For a relay station set in the routing parameter, set a relay station of the own network which is routed by the transient transmission.

**Ex.**

A setting to perform transient transmission to network number ●

To go to network No. ●, station No. ▲ of its own network No. ■.

	Target Network No.	Relay Network No.	Relay Station No.
1	●	■	▲

No routing parameter setting is required for network No. ● because the module of network No. ● is mounted on the relay station.

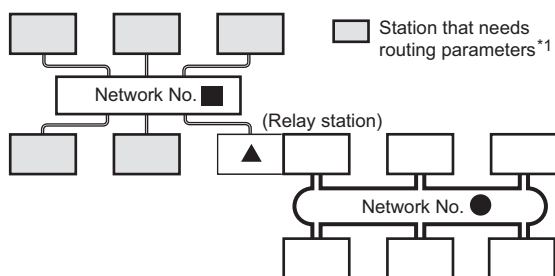

\*1 The stations, which routing parameter settings are not supported such as head modules, do not need to be set. The communication with other networks is made depending on the routing parameters set to the master station.

### Point

- Transient transmission range  
Communications can be made with stations on up to the eighth network (the number of relay stations: 7).
- To check whether routing parameters have been correctly set and transient transmission will be successfully performed, perform a communication test in CC-Link IE Field Network diagnostics. (☞ Page 54 Communication test)
- On a relay station in the multiple CPU system, when different control CPUs are set for the network modules Set the same routing parameters to all the control CPUs.

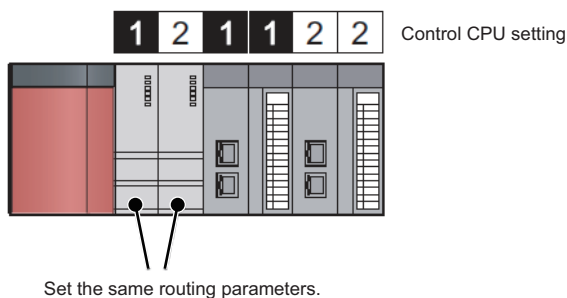

## Stations that need routing parameter settings

Routing parameter settings are required for relay stations and a request source which performs transient transmission to other networks.

**Ex.**

A setting to perform transient transmission from the station number 2 on the network number 1 to the station number 4 on the network number 3

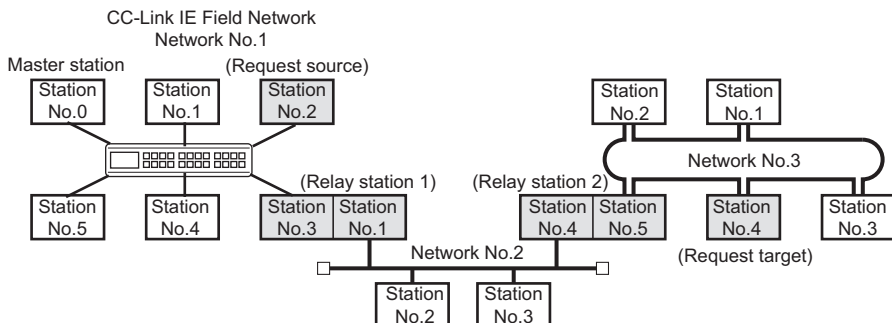

Station	Transient transmission (request)			Transient transmission (response)													
Request source	Station No. 2	<table border="1"> <tr> <th>Target Network No.</th> <th>Relay Network No.</th> <th>Relay Station No.</th> </tr> <tr> <td>3</td> <td>1</td> <td>3</td> </tr> </table> <p>Transmit data through station No. 3 on network No. 1 to communicate with network No. 3.</p>	Target Network No.	Relay Network No.	Relay Station No.	3	1	3	Station No. 2								
Target Network No.	Relay Network No.	Relay Station No.															
3	1	3															
Relay station 1	<table border="1"> <tr> <th>Target Network No.</th> <th>Relay Network No.</th> <th>Relay Station No.</th> </tr> <tr> <td>3</td> <td>2</td> <td>4</td> </tr> </table> <p>Transmit data through station No. 4 on network No. 2 to communicate with network No. 3.</p>	Target Network No.	Relay Network No.	Relay Station No.	3	2	4	<table border="1"> <tr> <th>Target Network No.</th> <th>Relay Network No.</th> <th>Relay Station No.</th> </tr> <tr> <td>1</td> <td>2</td> <td>1</td> </tr> </table> <p>Transmit data through station No. 1 on network No. 2 to communicate with network No. 1.</p>	Target Network No.	Relay Network No.	Relay Station No.	1	2	1	Station No. 3 Station No. 1	Pass data to the request source on network No. 1.	
Target Network No.	Relay Network No.	Relay Station No.															
3	2	4															
Target Network No.	Relay Network No.	Relay Station No.															
1	2	1															
Relay station 2	Passes data to the request target on network No. 3.		Station No. 4 Station No. 5	<table border="1"> <tr> <th>Target Network No.</th> <th>Relay Network No.</th> <th>Relay Station No.</th> </tr> <tr> <td>1</td> <td>2</td> <td>1</td> </tr> </table> <p>Transmit data through station No. 1 on network No. 2 to communicate with network No. 1.</p>			Target Network No.	Relay Network No.	Relay Station No.	1	2	1					
Target Network No.	Relay Network No.	Relay Station No.															
1	2	1															
Request target			Station No. 4	Pass data to the relay station automatically.													

- Setting for stations that do not perform transient transmission to other networks

Routing parameters are not required for stations that do not perform transient transmission to other networks; however, setting the same routing parameters to all stations is recommended.

Note that routing parameters need not to be set for stations for which routing parameters are not available (such as a station including a head module). The station communicates with other networks according to routing parameters set to the master station.

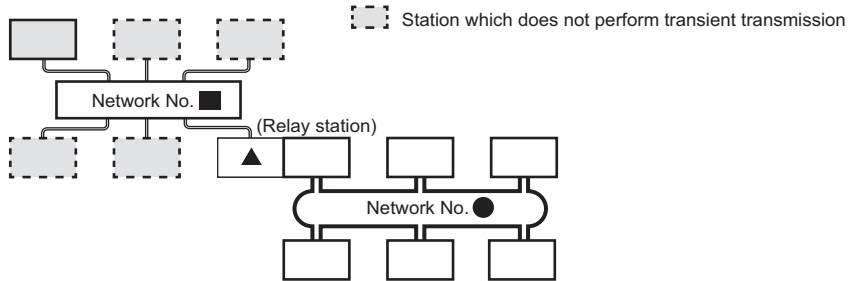

It is recommended to set the same routing parameters as  for  and  can communicate by the same routing parameters, since they pass through the same relay station.

# 11 OPERATING BOARD ONLINE

This chapter explains a method for operating a board online using CC IE Field Utility.

## 11.1 Setting Board Channel Numbers

This section explains a method for checking/setting board channel numbers.



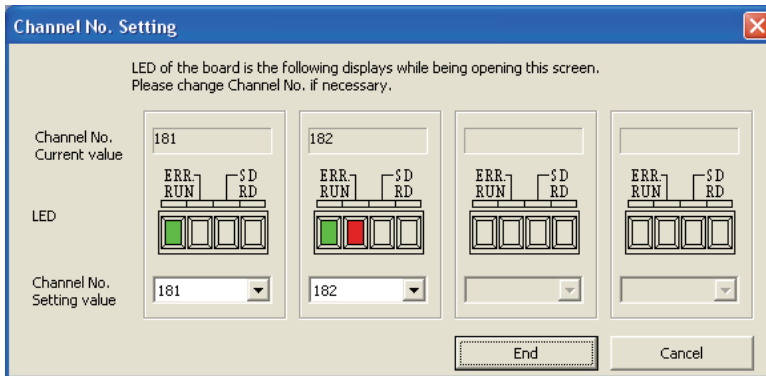

### Window

 [Online] ⇒ [Channel No. Setting]



### Operating procedure

1. Set the items in the screen.

Item	Description
Channel No. Current Value	Display current channel numbers of each board.
LED	Display LED status of each board. <ul style="list-style-type: none"> <li>The status is displayed as shown below according to the current channel number while opening the "Channel No. Setting" screen.</li> </ul> <div style="display: flex; justify-content: space-around; align-items: center;"> <div style="text-align: center;"> <p>&lt;181&gt;</p>  </div> <div style="text-align: center;"> <p>&lt;182&gt;</p>  </div> <div style="text-align: center;"> <p>&lt;183&gt;</p>  </div> <div style="text-align: center;"> <p>&lt;184&gt;</p>  </div> </div>
Channel No. Setting Value	Set the channel number to be changed.

2. Click the [End] button.

"Channel No. Setting Value" is set to the board.

### Point

181 is set for the board channel number as a factory default.

When using two or more boards in a single personal computer, set channel numbers not to overlap.

# 11.2 Writing/Reading Parameters to/from Board

This section explains methods for writing project parameter settings to the board and reading current board parameter settings to the project.

## Operating procedure

1. Select [Online] ⇒ [Read from Board]/[Write to Board]

### Point

- Channel numbers

Parameter settings to be written to the board are reflected to the board of the corresponding channel number.

Change board channel numbers in the "Channel No. Setting" screen. (  Page 120 Setting Board Channel Numbers)

	Board 1	Board 2	Board 3	Board 4
Network Type	CC IE Field (Master Station) ▾	CC IE Field (Local Station) ▾	None ▾	None ▾
Channel No.	181 ▾	182 ▾		
Network No.	1	1		
Total Stations	2			
Station No.	0	1		
Mode	Online (Normal Mode) ▾	Online ▾		
	<a href="#">Network Configuration Setting</a>			
	<a href="#">Network Operation Setting</a>	<a href="#">Network Operation Setting</a>		
	<a href="#">Event Setting</a>	<a href="#">Event Setting</a>		
	Parameter setting of channel number 181	Parameter setting of channel number 182		

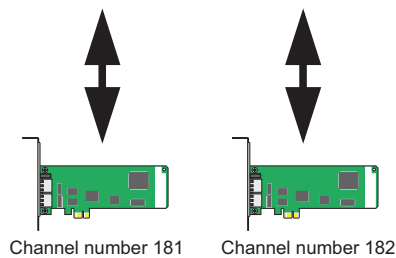

- Creating a new project with data read from the board

A new project is created with the data read from the board when data are read from the board before creating a new project. (  Page 90 Creating Projects)

## 11.3 Verifying Parameters of Board and Project

This section explains a method for verifying parameters set to the board and parameters of open project. Use this function to check if the parameters of the projects are the same, or to check the changed parameter locations. To verify two projects, perform the project verification. (☞ Page 96 Verifying Project Data)

### Operating procedure

1. Select [Online] ⇒ [Verify with Board]

The verify result is displayed in the "Verify Result" screen.

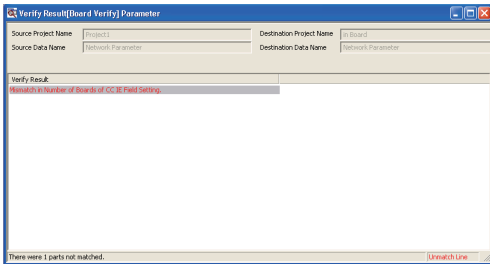

## 11.4 Resetting Board

This section explains a method for resetting the board from CC IE Field Utility.

### Window

- ☞ [Online] ⇒ [Reset Operation]

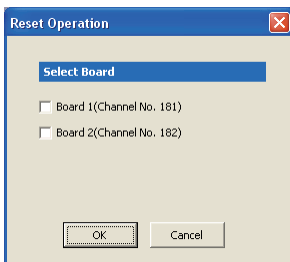

### Operating procedure

1. Check the check box of the board to be reset.
2. Click the [OK] button.

The selected board is reset.

# 12 MONITORING

---

This function is performed using Device Monitor Utility.

For Device Monitor Utility, refer to the following:

📖 MELSEC Data Link Library Reference Manual

# MEMO

---

# 13 DIAGNOSING BOARD STATUS

This chapter explains the methods for diagnosing the board or CC-Link IE Field Network status using CC IE Field Utility.

## 13.1 Diagnosing Board

This section explains a method for checking the board status.

### Window

 [Diagnostics] ⇨ [Board Diagnostics]

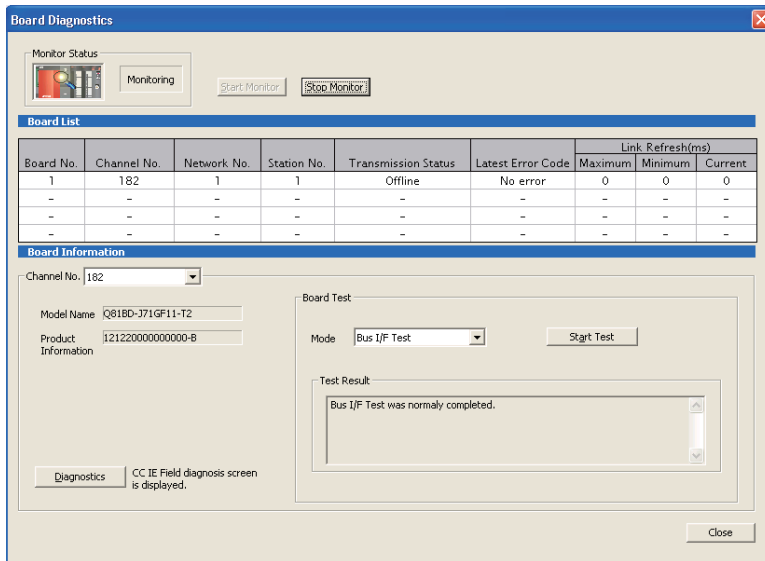

### Displayed items

Item	Description	
Monitor Status	Displays current monitor status.	
Board List	Board No.	Displays the board number of each board.
	Channel No.	Displays the channel number of each board.
	Network No.	Displays the network number set for each board.
	Station No.	Displays the station number set for each board.
	Transmission Status	Displays communication status of each board.
	Latest Error Code	Displays the latest error code of board.
	Link Refresh	Displays the maximum, minimum, and current time of link refresh.
Board Information	Channel No.	Select a board channel number of a test target or information display target.
	Model Name	Displays a model name of the selected board.
	Product Information	Displays product information of the selected board.
	Board Test	Executes a test on the selected board.
[Diagnostics] button	Displays the "CC IE Field Diagnostics" screen. (  Page 128 Displaying diagnostics screen)	

## Operating procedure

**1.** Click the [Start Monitor] button and start monitoring.

Click the [Stop Monitor] button to stop monitoring.

**2.** Set a board channel number of a test target or information display target.

**3.** Select a test mode for "Mode".

**4.** Click the [Start Test] button.

Start the board test.

**5.** Result is displayed in the "Test result" field.

## 13.2 Diagnosing CC-Link IE Field Network

This section explains a method for checking the CC-Link IE Field Network status of a selected board.

Target station by CC IE Field Utility for the CC-Link IE Field Network diagnostics is as follows.

Board/module	Station type	Model name
CC-Link IE Field Network board	Master station/Local station	Q80BD-J71GF11-T2 Q81BD-J71GF11-T2
Master/local module	Master station/Local station	RJ71EN71*1 RJ71GF11-T2 QJ71GF11-T2 LJ71GF11-T2
Bridge module	Intelligent device station	NZ2GF-CCB
Head module	Intelligent device station	LJ72GF15-T2
Ethernet adapter module	Intelligent device station	NZ2GF-ETB
Basic digital input module	Remote device station	NZ2GF12A4-16D NZ2GF12A4-16DE NZ2GF2B1-16D NZ2GF2B2-16A NZ2GF2S1-16D NZ2GF2S2-16A NZ2GFCE3-16D NZ2GFCE3-16DE NZ2GFCM1-16D NZ2GFCM1-16DE NZ2GFCE3-32D
	Intelligent device station	NZ2GF2B1-32D NZ2GFCF1-32D
Basic digital output module	Remote device station	NZ2GF12A2-16T NZ2GF12A2-16TE NZ2GF2B1-16T NZ2GF2B1-16TE NZ2GF2B2-16R NZ2GF2B2-16S NZ2GF2S1-16T NZ2GF2S1-16TE NZ2GF2S2-16R NZ2GF2S2-16S NZ2GFCE3-16T NZ2GFCE3-16TE NZ2GFCM1-16T NZ2GFCM1-16TE NZ2GFCE3-32T
	Intelligent device station	NZ2GF2B1-32T NZ2GF2B1-32TE NZ2GFCF1-32T
Basic digital I/O combined module	Remote device station	NZ2GF12A42-16DT NZ2GF12A42-16DTE NZ2GFCE3-32DT
	Intelligent device station	NZ2GF2B1-32DT NZ2GF2B1-32DTE NZ2GFCF1-32DT
Basic analog input module	Remote device station	NZ2GF2B-60AD4 NZ2GFCE-60ADI8 NZ2GFCE-60ADV8
Basic analog output module	Remote device station	NZ2GF2B-60DA4 NZ2GFCE-60DAI8 NZ2GFCE-60DAV8
Basic multiple input (voltage/current/temperature) module	Remote device station	NZ2GF2S-60MD4
Basic temperature control module	Remote device station	NZ2GF2B-60TCRT4 NZ2GF2B-60TCTT4
Basic high-speed counter module	Remote device station	NZ2GFCF-D62PD2

\*1 When using a CPU module with a built-in port that supports CC-Link IE Field Network, select a model name with '\_' (underscore).

# Selecting the diagnostics target

The following explains the target selection for CC-Link IE Field Network diagnostics.

The entire network status can be checked by connecting CC IE Field Utility to a master station. However, when a local station status cannot be checked because of a failure such as a cable disconnection, connect the utility to a local station directly.

## Selecting diagnostics target board

When two or more CC-Link IE Field Network boards are installed to a personal computer, the "Select Diagnostics Destination" screen as shown below is displayed before starting diagnostics. Select a board to be diagnosed and click the [OK] button.

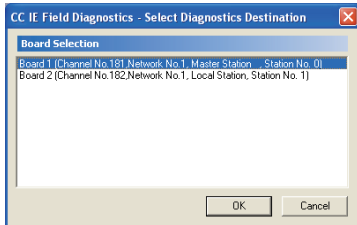

## Changing diagnostics target board

To change a board to be diagnosed during the CC-Link IE Field Network diagnostics, click the [Change Board] button in the "CC IE Field Diagnostics" screen. The "Board Change" screen appears.

Select a board to be diagnosed, and click the [OK] button.

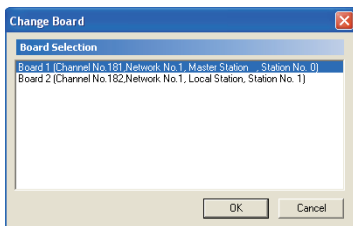

# Displaying diagnostics screen

The following explains the diagnostics screen of CC-Link IE Field Network.

## Window

[Diagnostics] ⇒ [CC IE Field Diagnostics]

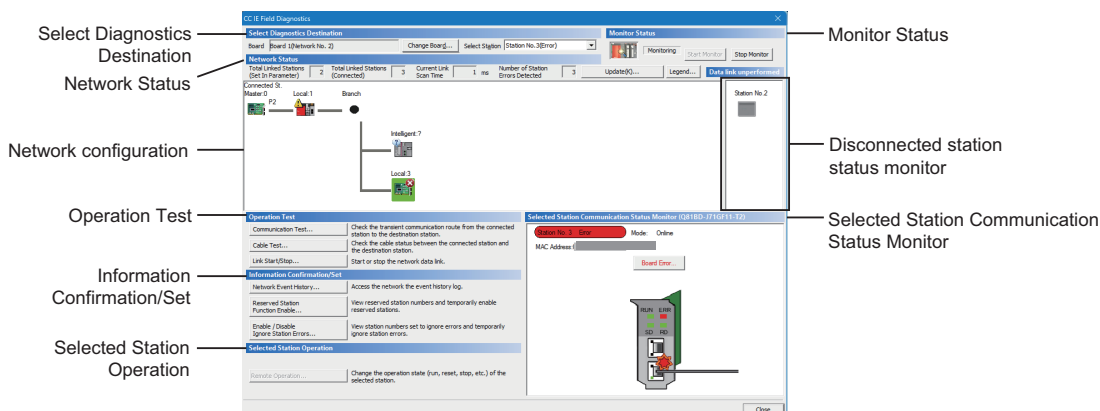

## Displayed items

○: Diagnosed, △: Diagnosed with restrictions, ×: Not diagnosed

Item		Diagnostics target		Restrictions	Reference
		Master station	Local station		
Select Diagnostics Destination		—	—	—	Page 131 Select diagnostics target
Monitor Status		—	—	—	Page 131 Monitor status
Network Status, Network configuration, Legend	Display of network configuration and error status	○	○	—	Page 131 Network status Page 132 Legend Page 133 Network configuration
	Display of disconnected cable and disconnected station	○	○		
Data link unperformed	Disconnected station status monitor	—	—	—	Page 136 Disconnected station status monitor
Selected Station Communication Status Monitor	Display of selected station status and error details	○	○	The selected station status and error details are not displayed when using a module which is not supported by the selected station communication status monitor function of CC IE Field Utility.	Page 136 Selected station communication status monitor
	Device station number setting (Only for device stations whose number has not been set.)	○	×	—	
Operation Test	Communication Test	○	○	—	Page 138 Communication test
	Cable Test	○	○	—	Page 139 Cable test
	Link Start/Stop	○	△	For a local station, this function can only be performed on an own station.	Page 140 Link start/stop
Information Confirmation/Set	Network Event History	○	○	Events that can be collected differ according to the station type.	Page 141 Network event history
	Reserved Station Function Enable	○	△	For a local station, reserved stations/temporary error invalid stations can only be displayed.	Page 143 Reserved station function enable
	Temporary Error Invalid Station Setting/Restore	○	△		Page 144 Enable/Disable ignore station errors
Selected Station Operation	Remote Operation	—	△	Available only when the selected station is a remote device station	Page 145 Remote operation of a selected station

### Point

- Starting from the "Board Diagnostics" screen  
CC-Link IE Field Network diagnostics can also be started from the "Board Diagnostics" screen. (  Page 125 Diagnosing Board)

## Operating procedure

1. Select a station to be diagnosed from "Select Station" or "Network Status".

(☞ Page 131 Select diagnostics target, Page 133 Network configuration)

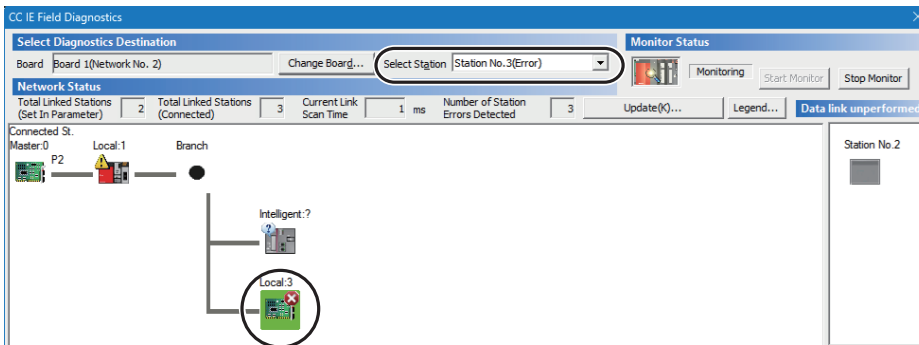

Item	Description
Station where errors occurred	✖, ⚠, or ? is displayed on the module icon of the station where an error occurs.
Disconnected station	The 'disconnected station' icon ( ) is displayed on the network configuration. For disconnected stations displayed on "Disconnected station status monitor", refer to the following: ☞ Page 136 Disconnected station status monitor
Communication error	✖ is displayed on the icon of a cable where a communication error occurs. To check the details of the communication error, click the neighboring stations of ✖.
When the loopback function is disabled	✖ is displayed if the network is configured in ring topology.
When the loopback function is enabled	✖ is displayed if the network is configured in star topology.
When the network is incorrectly configured in ring topology	✖ is displayed.

2. Status of a station selected in "Network Status" is displayed on the "Selected Station Communication Status Monitor".

(☞ Page 136 Selected station communication status monitor)

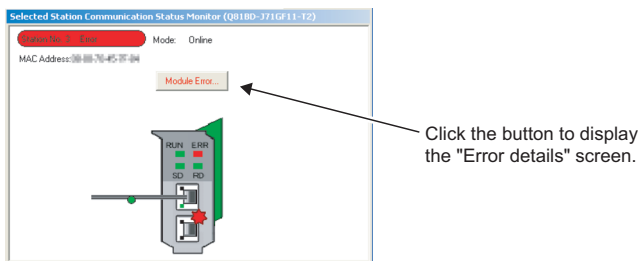

- The station status is displayed on the top of "Selected Station Communication Status Monitor".
- If an error occurs, a button indicating the error (such as [Module Error] button) is displayed on the "Selected Station Communication Status Monitor". Clicking the button allows checking of error details and corrective actions.

3. Various tests and operations can be performed from "Operation Test," "Information Confirmation/Set," and "Selected Station Operation" on the bottom left of the screen.

(☞ Page 138 Communication test to Page 145 Remote operation of a selected station)

<b>Operation Test</b>	
Communication Test...	Check the transient communication route from the connected station to the destination station.
Cable Test...	Check the cable status between the connected station and the destination station.
Link Start/Stop...	Start or stop the network data link.
<b>Information Confirmation/Set</b>	
Network Event History...	Access the network's event history log.
Reserved Station Function Enable...	View reserved station numbers and temporarily enable reserved stations.
Enable / Disable Ignore Station Errors...	View station numbers set to ignore errors and temporarily ignore station errors.
<b>Selected Station Operation</b>	
Remote Operation...	Reset the selected station, (reset, stop, etc.) of the selected station.

## Select diagnostics target

### Window

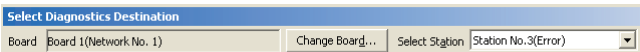

### Displayed items

Item	Description
Board	Display the selected diagnostics target board and the network number.
Select Station	Display the station number of the station selected in the network configuration. Set the station number to be selected.
[Change Board] button	Displays the "Change Board" screen. (Page 128 Selecting the diagnostics target)

### Point

- Selecting a target from "Network Status"  
A diagnostics target can also be selected from the network configuration of "Network Status".

13

## Monitor status

Display current monitor status.

### Window



### Displayed items

Item	Description
[Start Monitor] button	Starts monitoring.
[Stop Monitor] button	Stops monitoring.

## Network status

### Window

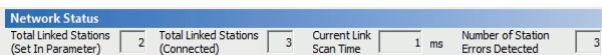

### Displayed items

Item	Description
Total Linked Stations	Display the total number of linked stations, the link scan time (in units of ms), and the number of stations error occurrences on the network being displayed.
Current Link Scan Time	
Number of Station Errors Detected	

## Legend

Displays the explanation for icons displayed in the diagnostics screen.

## Window

Click the [Legend] button.

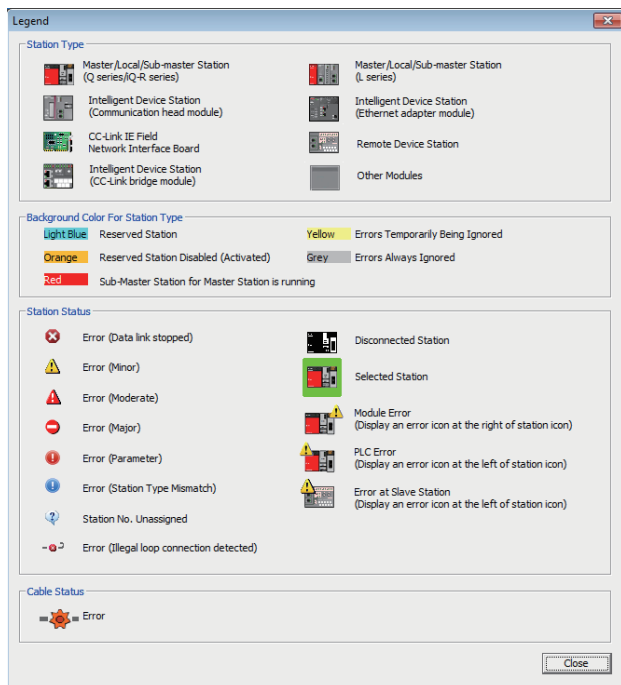

## Point

- Station type display of the icon

When modules other than the target of the CC-Link IE Field Network diagnostics ( [Page 127 Diagnosing CC-Link IE Field Network](#) ) are used in a local station, it is displayed as "Other Modules" (  ).

## Network configuration

CC-Link IE Field Network configuration and status of each station are displayed.

When the status of each station is not displayed, check if master stations or station numbers are not duplicated.

### Window

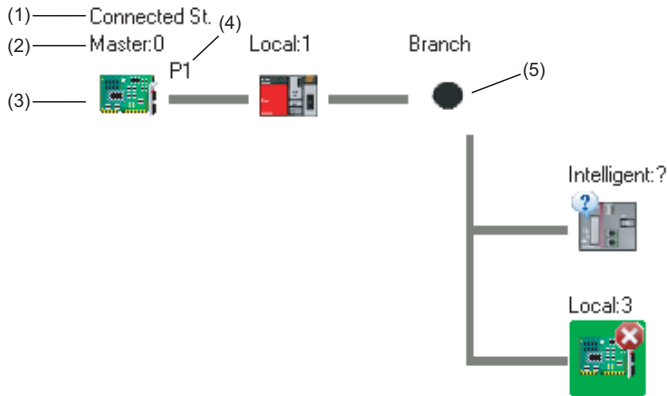

### Displayed items

No.	Item	Description
(1)	Connected Station	Indicates a station connected to the utility (own station).
(2)	Network type Station No.	Displays a network type and station number. "?" is displayed when a station number has not been set. When the background of the characters is colored, setting such as reserved station specification has been configured to the relevant station.
(3)	Icon	Displays a module type and station status.
(4)	Port	Displays a port to which an Ethernet cable is connected.
(5)	Divergence	A branch of star topology configured by using a network device such as a hub.

### Icon

By clicking an icon, the station is set as a selected station and details are displayed in "Selected Station Communication Status Monitor".

(A station with an error, such as master station duplication or station number duplication, details are not displayed as a selected station even by clicking the icon. In such case, execute the board diagnostics on the error station, and determine the error cause. When the error station is a module, determine the error cause using the system monitor function of GX Works2.)

Use the right and left arrow keys to move the focus and press the **[Space]** or **[Enter]** key to confirm the selected station.

The same functions as the functions of "Operation Test" and "Information Confirmation/Set" can be executed from the menus displayed by right-clicking the icon.

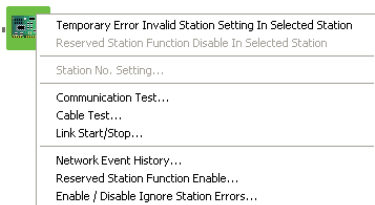

The content of the displayed icons can be confirmed with the **[Legend]** button. ( Page 132 Legend)

## ■When is displayed in "Network Status"

<The system does not contain a switching hub.>

Although the loopback function is disabled, the network is configured in ring topology.

Perform the following measures.

- When not using the loopback function

Disconnect an Ethernet cable connected to any stations on the network (either PORT1 or PORT2).

The network topology will become a line topology and data link will start.

- When using the loopback function

Enable the loopback function and rewrite the network parameter to the board. ( Page 76 Loopback Function)

When a master/local module is used for the master station, check if the master/local module supports the loopback function.

If the master/local module does not support the loopback function, replace the module with the one which supports the loopback function.

<The system contains a switching hub.>

 is displayed by any of the following causes.

- Although the loopback function is disabled, the network is configured in ring topology.
- Although the loopback function is enabled, the network is configured in star topology.
- The network is incorrectly configured in ring topology.

Perform the following measures.

- Check if the loopback function setting is correctly configured. ( Page 76 Loopback Function)

If incorrect, correct the network parameter and rewrite it to the board.

When data link starts over the network, the action is successful.

- When the loopback function is disabled, perform the following measures.

Disconnect an Ethernet cable connected to the switching hub and power cycle the hub. (Repeat this operation until data link starts over the network.)

When data link starts over the network, check the network configuration by CC-Link IE Field Network diagnostics.

- When the loopback function is enabled, perform the following measures.

Configure the network in ring topology without a switching hub.



Connecting a switching hub will cause a problem such as data link failure. ( Page 24 Configuration in which data link cannot be performed (incorrect ring topology))

When a master/local module is used for the master station, check if the master/local module supports the loopback function.

If the master/local module does not support the loopback function, replace the module with the one which supports the loopback function.

## ■Display of network configuration

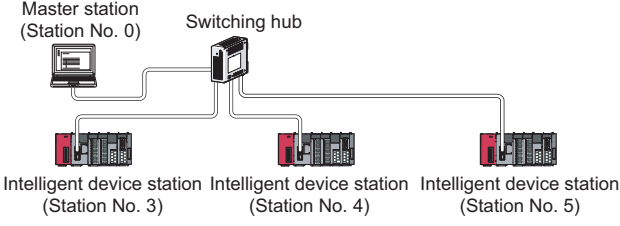
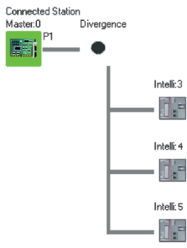
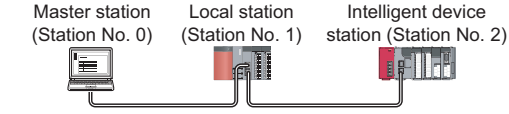
Network configuration is displayed according to the connection status.

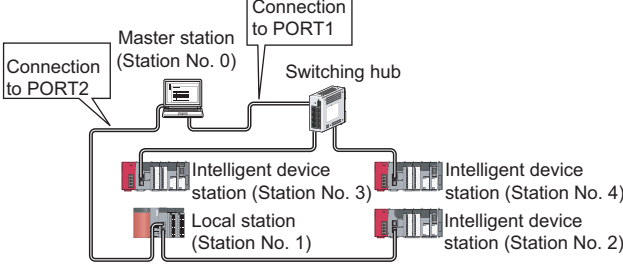
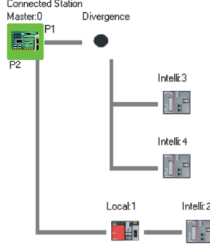
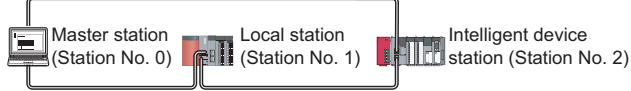
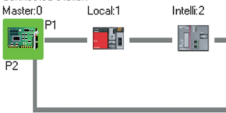
Network configuration	Actual system configuration	Network configuration
Star topology		
Line topology		
Star and line mixed		
Ring topology		

However, in the following cases, network configuration displayed in the network configuration screen differs from the actual configuration.

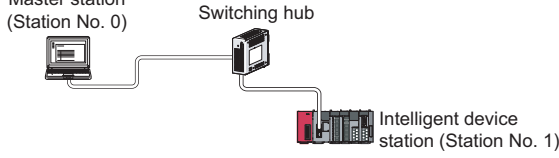
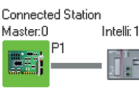
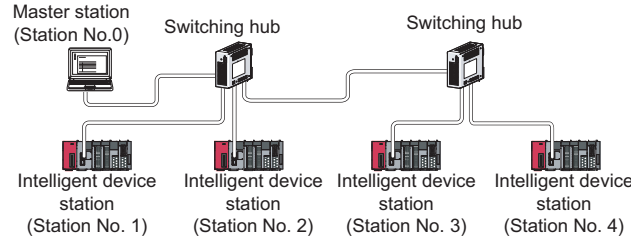
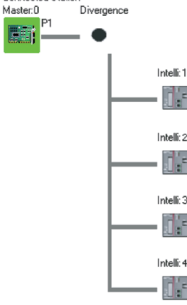
Network configuration	Actual system configuration	Network configuration
Two stations are connected through a switching hub.		<p>Branches are not displayed in the network configuration display area.</p> 
Switching hubs are in cascade connection.		<p>Only one branch is displayed.</p> 

Click the [Update] button to update the network configuration diagram as follows:

- When a serial number (first five digits) of the master station is "17022" or higher, and if the network configuration diagram in the diagnostic screen does not match with the actual network configuration, match it by updating the network configuration diagram. Whether mismatch is occurred or not can be checked using 'Network configuration mismatch occurrence status' (SB0098). (  Page 26 When a serial number (first five digits) of the master station is '17022' or higher)
- When a serial number (first five digits) of the master station is "17021" or lower, delete the disconnected station displayed on the network configuration diagram. The disconnected station is displayed on "Disconnected station status monitor".

## Disconnected station status monitor

Displays a disconnected station that has been set in the network configuration settings but has not yet performed data link. However, even if a disconnected station has performed data link, it is displayed in this area in the following cases.

- A station that was reconnected to a network after cable disconnection/insertion or power-OFF and power-ON of the system and remains disconnected
- A station that was disconnected with the station icon deleted in the network map display area by clicking the [Update] button

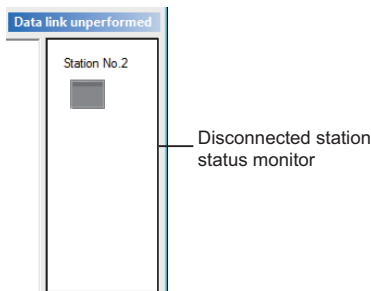

The  icon indicates a station that has not yet performed data link.

Icons other than  indicate stations that had performed data link before disconnection.

## Selected station communication status monitor



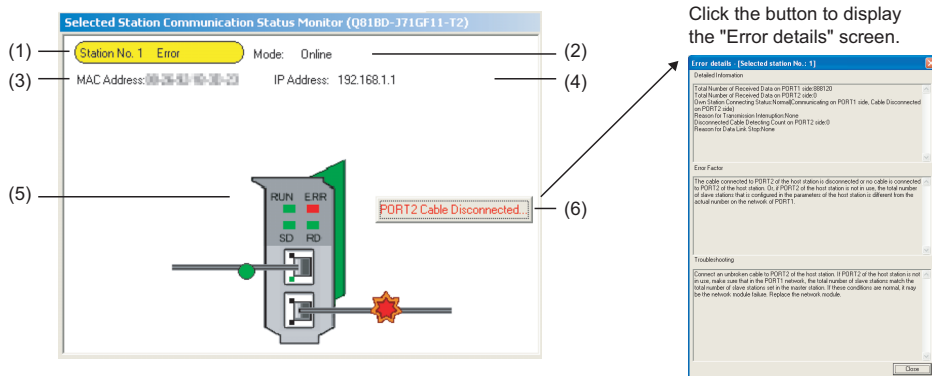

Display status of the selected station.

### Window

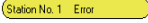

Click the button to display the "Error details" screen.

## Displayed items

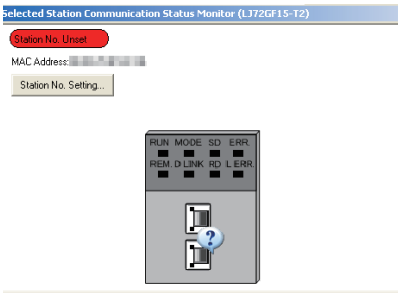
No.	Item	Description
(1)	Operating status	Display the station number and operating status.  : Normal  : Error (Data link is continued.) (yellow)  : Error (Data link is stopped.) (red)  : Station number is not specified. (red)
(2)	Mode	Display the mode. It is not displayed if a station number is not specified.
(3)	MAC Address	Display the MAC address.
(4)	IP Address	Displays an IP address (only when it is set).
(5)	LED	Display LED status and communication status of PORT1 and PORT2. Display the  icon when the target station is disconnected.
(6)	Error buttons	An error button is displayed when an error occurs on the CC-Link IE Field Network board or connection cable. The "Error details" screen is displayed by clicking the button.
(7)	[Station No. Setting] button	This button is displayed when a station number is not specified for the selected station. The "Station number setting" screen for changing the station number is displayed by clicking the button.  

13

### ■ Specifying station number

Specify a station number for the station number unspecified station when the connected station is a master station.

## Window

 [Diagnostics] ⇒ [CC IE Field Diagnostics] ⇒ "CC IE Field Diagnostics" screen ⇒ [Station No. Setting] button

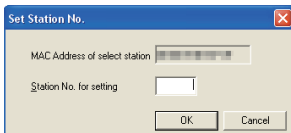

## Operating procedure

1. Set the items in the screen.

Item	Description
MAC Address of select station	Display the MAC address of the selected station.
Station No. for setting	Set the station number. Setting range: 1 to 120, numerals (0 to 9) in 3 digits only

2. Click the [OK] button.

### Point

- Adding a station set in "Network Configuration Setting"  
The external device on a device station outputs data input from the master station, simultaneously with configuration of the station number setting. Therefore, set the CPU module to STOP or check that outputs from the external device will not cause a problem beforehand.
- A station number is not specified to the device station  
For a method for canceling the station number set to the device station in the CC-Link IE Field Network Diagnostics, refer to the manual of device station being used.

# Communication test

Perform a communication test on CC-Link IE Field Network.

## Window

[Diagnostics] ⇒ [CC IE Field Diagnostics] ⇒ "CC IE Field Diagnostics" screen ⇒ [Communication Test] button

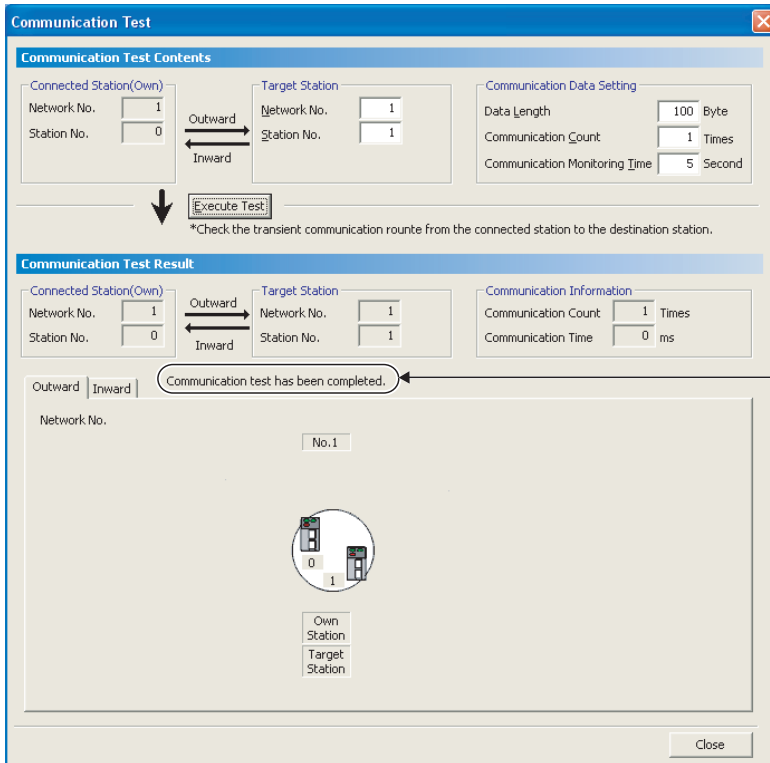

Presence or absence of errors on the communication test

## Operating procedure

1. Set the items in the screen.

Item		Description
Communication Test Contents	Connected Station (Own)	Display the network number and station number of the connected station.
	Target Station	Set the network number and station number.
	Communication Data Setting	Set the data length (1 to 900 bytes), the number of communications (1 to 100 times), and monitoring time (1 to 100 seconds) to execute the test.

2. Click the [Execute Test] button.

The communication test is executed according to the set contents.

## Displayed items

Item	Description
Communication Test Result	Displays the result of inter-network communication test. Also in 'Presence or absence of errors on the communication test', displays whether the communication test has been executed normally. Networks and stations routed from the own station (connected station) to the target station are displayed in the <<Outward>> tab and those routed from the target station to the own station (connected station) are displayed in the <<Inward>> tab.

# Cable test

Test the status of the cable connections between the testing station and the devices connected to the ports of the testing station.

## Window

[Diagnostics] ⇒ [CC IE Field Diagnostics] ⇒ "CC IE Field Diagnostics" screen ⇒ [Cable Test] button

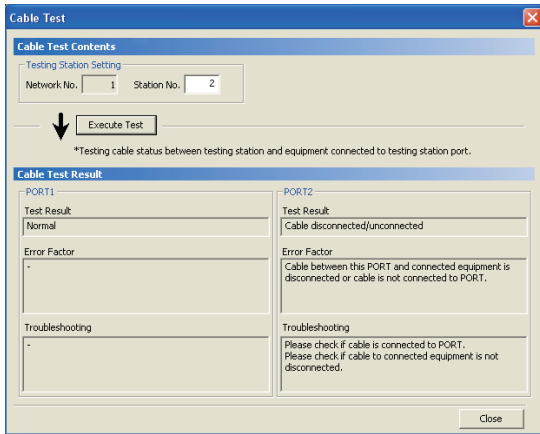

## Operating procedure

1. Set the items in the screen.

Item	Description	
Cable Test Contents	Testing Station Setting	Set the network number and station number of the station which executes the cable test.

2. Click the [Execute Test] button.

The cable test is executed on the testing station.

## Displayed items

Item	Description
Cable Test Result	Display the cable test result, error factor, and troubleshooting of each port.

# Link start/stop

Start/stop the data link of a specified station. Use this function for debugging purposes to stop the station from receiving data from other stations and sending its own data.

## Window

[Diagnostics] ⇒ [CC IE Field Diagnostics] ⇒ "CC IE Field Diagnostics" screen ⇒ [Link Start/Stop] button

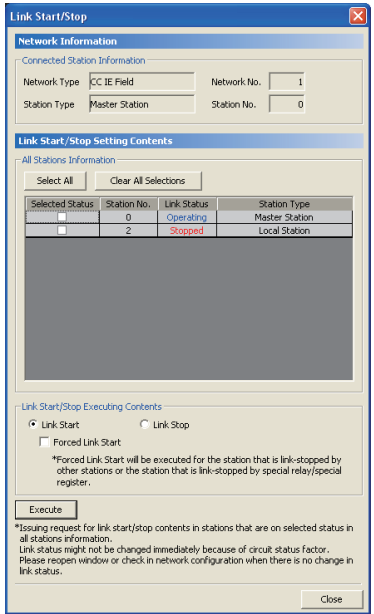

## Operating procedure

1. Set the items in the screen.

Item	Description	
Network Information	Connected Station Information	Display the network information of the connected station.
Link Start/Stop Setting Contents	All Stations Information	Display the link status of all stations on the same network which are performing the data link with the connected station. Target stations of the link start/stop operation can be selected in "Selected Status".
	Link Start/Stop Executing Contents	Select "Link Start"/"Link Stop". To forcibly start the data link of a station which has been stopped by another station or a special relay/special register, check "Forced Link Start".
[Select All] button	Selects all stations displayed in the list.	
[Cancel All Selections] button	Cancels the selection status of all stations selected in the list.	

2. Click the [Execute] button.

The link start/stop is executed for all selected stations at once.

When the process is completed, "Selected Status" are cleared and the contents of "Link Status" are updated.

# Network event history

Display a list of event history occurred on the own station and on the network.

## Window

[Diagnostics] ⇒ [CC IE Field Diagnostics] ⇒ "CC IE Field Diagnostics" screen ⇒ [Network Event History] button

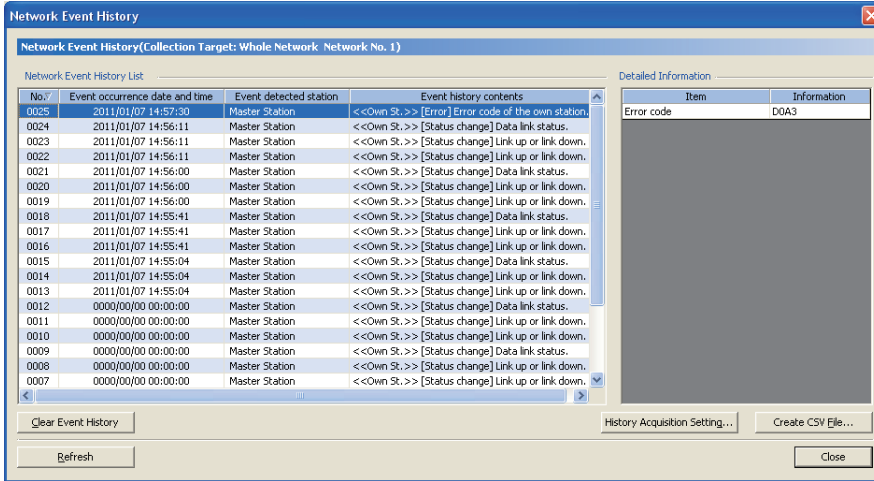

## Displayed items

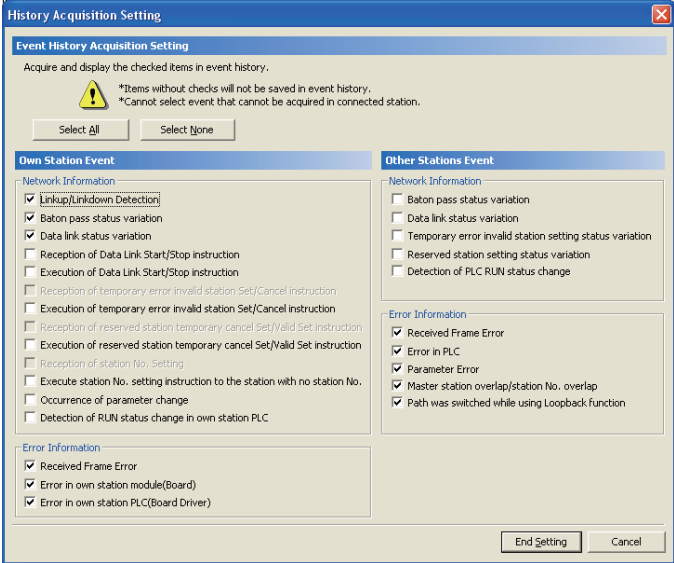
Item	Description
Network Event History	Network Event History List Display the list of network event history. Each column can be sorted in ascending/descending order by clicking on the column header.
	Detailed Information Display the detailed information of an event selected in "Network Event History List".
[History Acquisition Setting] button	Displays the "History Acquisition Setting" screen. Select events to be acquired. 
[Clear Event History] button	Clears the network event history existing in the board.
[Create CSV File] button	Saves the network event history in CSV file format.

- The number of displayed events  
Up to 1000 events can be displayed. When the maximum is reached, the events will be erased in sequence from the oldest one and the latest events will be displayed.
- Incorrect display of error occurrence time and date  
If an error occurs during initial processing, '0000/00/00 00:00:00' will be displayed.
- Sorting event history data  
Click each title to sort events.

Network Event History(Collection Target: Whole Network Network No. 1)

Network Event History List

No.	Event occurrence date and time	Event detected station	Event history contents
0024	2011/01/07 14:56:11	Master Station	<<Own St.>> [Status change] Data link status.
0023	2011/01/07 14:56:11	Master Station	<<Own St.>> [Status change] Link up or link down.

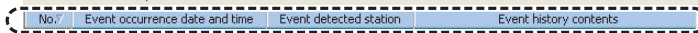
 Click

- The board automatically saves event history data on the flash ROM.
- Auto-save may fail if it operates after the board is reset or powered OFF and later ON until initial processing is completed. If failed, the event, "Invalid event history data." is displayed in "Event history contents".
- An event, generated one second before the board is reset or powered OFF, is not saved to event history.

# Reserved station function enable

Cancel reserved stations temporarily and reserve the stations again.

This function cannot be performed when the connected station is a local station.

## Window

[Diagnostics] ⇒ [CC IE Field Diagnostics] ⇒ "CC IE Field Diagnostics" screen ⇒ [Reserved Station Function Enable] button

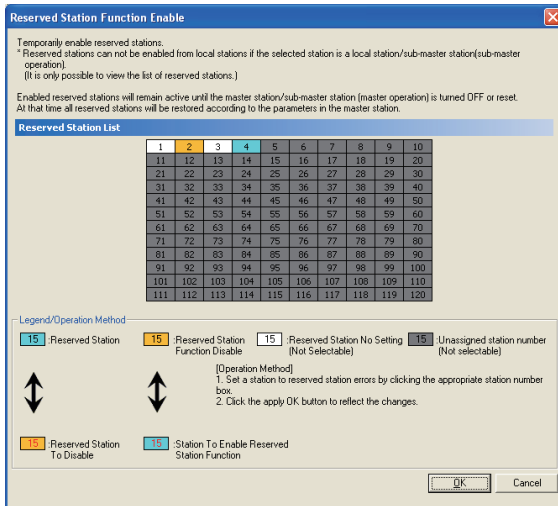

## Operating procedure

1. Select reserved stations to be canceled temporarily or reserved again from "Reserved Station List".
2. Click the [OK] button.

The selected reserved stations are canceled temporarily or reserved again.

When the process is completed, the contents of "Reserved Station List" are updated.

### Point

- Parameter setting  
The network parameter does not reflect the temporary cancellation of reserved station specification.
- Resetting master station or turning OFF the system  
The temporary cancellation of reserved station specification is reset and the device station returns to the status set by the master station's network parameter.
- Disconnecting a station for which reservation has been temporarily cancelled  
If the master station is reset, the master station and local stations will differ in the following:  
ERR. LED status  
Data in Reserved station specification (SW00C0 to SW00C7) and Reserved station function disable status (SW0180 to SW0187)  
The difference can be corrected by the following procedure.
  1. Reconnect the disconnected station.
  2. Temporarily cancel the reservation and then reserve the station again.

# Enable/Disable ignore station errors

Set/restore temporary error invalid stations.

This function can be performed when the connected station is a master station.

## Window

[Diagnostics] ⇒ [CC IE Field Diagnostics] ⇒ "CC IE Field Diagnostics" screen ⇒ [Enable/Disable Ignore Station Errors] button

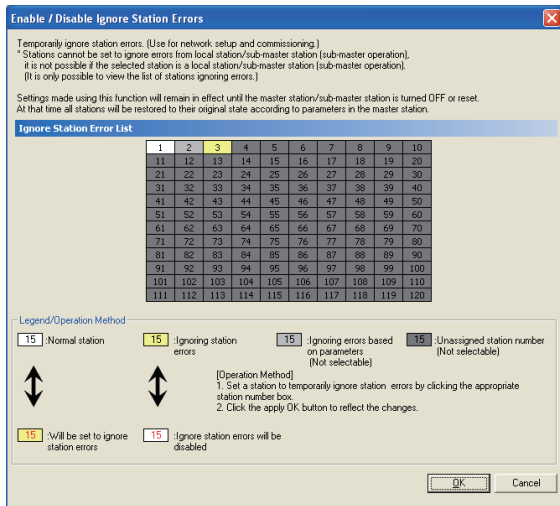

## Operating procedure

1. Select stations to be set/restored as temporary error invalid stations from "Error Invalid Station List".
2. Click the [OK] button.

The temporary error invalid stations are set/restored.

When the process is completed, the contents of "Error Invalid Station List" are updated.

- Station for which temporary error invalid station setting cannot be configured  
When reservation for a device station is temporarily canceled, temporary error invalid station setting cannot be configured for the station.
- An error invalid station is used in line topology.  
In the following cases, the station is not detected as a data link faulty station. However, stations subsequent to the disconnected station are detected as a data link faulty station.

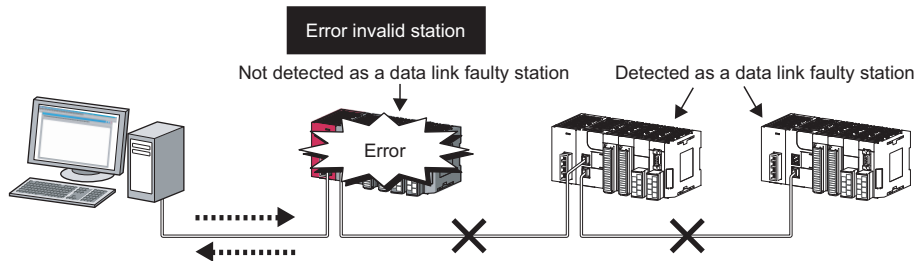

- Setting in the "Network status" in the "CC IE Field Diagnostics" screen  
The temporary error invalid station setting/restoration can be performed from the network configuration of "Network Status" in the "CC IE Field Diagnostics" screen.  
The menu is displayed by right-clicking the target station. (  Page 133 Icon)
- Parameter setting  
The network parameter does not reflect temporary error invalid station setting.
- Resetting the master station or powering off the system  
Temporary error invalid station setting is reset and the device station returns to the status set by the master station's network parameter.
- Disconnecting a station for which temporary error invalid station setting has been configured  
If the master station is reset, the master station and local stations will differ in the following:  
ERR. LED status  
Temporary error invalid station setting (SW00E0 to SW00E7)  
The difference can be corrected by the following procedure.
  1. Reconnect the disconnected station.
  2. Configure temporary error invalid station setting and then cancel the setting

## Remote operation of a selected station

When the selected station is a remote device station, the remote reset can be performed.

### Window

 [Diagnostics] ⇒ [CC IE Field Diagnostics] ⇒ "CC IE Field Diagnostics" screen ⇒ [Remote Operation] button

# 14 MELSEC DATA LINK LIBRARY

This chapter explains the features of the functions provided by the library.

These functions are used when creating a user program to communicate with a programmable controller CPU.

With these functions, a user can communicate without being aware of hardware types or communication protocols on the target.

The following table shows the list of MD functions which are provided with the software package.

Function name	Description
mdOpen	Open a communication line.
mdClose	Close a communication line.
mdSendEx	Batch write devices. (Extended function <sup>*1</sup> )
	Send data. (SEND function) (Extended function <sup>*1</sup> )
mdReceiveEx	Batch read devices. (Extended function <sup>*1</sup> )
	Receive data. (RECV function) (Extended function <sup>*1</sup> )
mdRandWEx	Write devices randomly. (Extended function <sup>*1</sup> )
mdRandREx	Read devices randomly. (Extended function <sup>*1</sup> )
mdDevSetEx	Set a bit device. (Extended function <sup>*1</sup> )
mdDevRstEx	Reset a bit device. (Extended function <sup>*1</sup> )
mdRemBufWriteEx	Write data to the buffer memory of a remote device station or remote station. <sup>*2</sup>
mdRemBufReadEx	Read data from the buffer memory of a remote device station or remote station. <sup>*2</sup>
mdTypeRead	Read the type of programmable controller CPU.
mdControl	Remote operation of programmable controller CPU. (RUN/STOP/PAUSE).
mdWaitBdEvent	Wait for an event occurrence.
mdBdRst	Reset the board.
mdBdModSet	Set the mode of the board.
mdBdModRead	Read the mode of the board.
mdBdLedRead	Read the LED information of the board.
mdBdSwRead	Read the switch status of the board.
mdBdVerRead	Read the version information of the board.
mdInit	Refresh the programmable controller device address.
mdSend	Batch write devices.
	Send data. (SEND function)
mdReceive	Batch read devices.
	Receive data. (RECV function)
mdRandW	Write devices randomly.
mdRandR	Read devices randomly.
mdDevSet	Set a bit device.
mdDevRst	Reset a bit device.

\*1 A function in which the access range is extended according to the extension of the device points at the access target. It is accessible to all device numbers. Use extended functions when creating a new program.

\*2 For the version of CC-Link IE Field Network board and SW1DNC-CCIEF-B that can be used for the functions, refer to the following:

 Page 233 Added and Changed Functions

## Point

For details on the MELSEC data link library function, refer to the following:

 MELSEC Data Link Library Reference Manual

# MEMO

---

# 15 PROGRAMMING

---

This chapter explains CC-Link IE Field Network programming.

## 15.1 Precautions on Programming

---

This section explains precautions for creating CC-Link IE Field Network programs.

### Cyclic transmission programs

For cyclic transmission programs, interlock with the following link special relay (SB) and link special register (SW). (☞ Page 198 Link Special Relay (SB) List, Page 209 Link Special Register (SW) List)

- Data link status (own station) (SB0049)
- Data link status (each station) (SW00B0 to SW00B7)

### Transient transmission programs

For transient transmission programs, interlock with the following link special relay (SB) and link special register (SW).

(☞ Page 198 Link Special Relay (SB) List, Page 209 Link Special Register (SW) List)

- Baton pass status (own station) (SB0047)
- Baton pass status (each station) (SW00A0 to SW00A7)



# 16 TROUBLESHOOTING

This chapter explains the identification of the causes and corrective actions when an error occurs. Perform the troubleshooting in the following order in case of trouble.

## Basic checking procedure

Check if there is a corresponding error symptom written in "Error Examples". (☞ Page 151 Error Examples)  
If the corresponding error could not be found, check the cause by following the procedure shown below.

### Operating procedure

- 1.** Check if all the boards installed on a personal computer are displayed with the utility.
  - ☞ Page 170 Checking channel numbers
  - ☞ Page 170 Checking operations with board diagnostics
- 2.** Check the LED display of the board.
  - ☞ Page 171 Checking LED status
- 3.** Check the error occurring at the utility.
  - ☞ Page 171 Checking operations with tests
  - ☞ Page 174 Checking network status with CC-Link IE Field Network diagnostics
  - ☞ Page 174 Checking network status with monitoring link special relays (SB) and link special registers (SW)
- 4.** Check the access target device.

Check whether the system is performing as set on the parameters and programs by checking the performance of link device communication, or transient transmission/reception.

  - ☞ Page 175 Checking communication status with monitoring access target device
- 5.** Check the user program.
  - ☞ Page 167 Checking operation environment
  - Check the arguments of the communication function:  MELSEC Data Link Library Reference Manual
  - Check the returned values of the communication function: ☞ Page 177 Error Code List

## When an error cannot be solved

If the problem is not solved by the corrective actions described in the manual, refer to the following section and contact us.  
☞ Page 176 Information Required for Inquiries

# 16.1 Error Examples

The following tables show examples of the major errors under the specific conditions. When a corresponding error occurs, refer to the troubleshooting of each error.

## Installation of the software package

Error	Description	Reference
Installation of the software package has failed.	Installation aborted.	Page 153 Installation failed
	Driver is not installed.	Page 156 When the driver is not installed
	A " ! " is displayed next to the icon of the driver name of board in the Device Manager screen of Windows.	Page 168 Checking with Device Manager
Uninstallation of the software package has failed.	The software package is not uninstalled despite the "uninstallation completed" message has been displayed.	Page 153 Uninstallation failed

## Personal computer and utility

Error	Description	Reference
Personal computer does not start or shuts down.	The system error is displayed when OS rebooting is stopped and blue screen appears.	Page 157 Personal computer does not start or shuts down
Personal computer shuts down.	The operating system down or system reset occurred when the system is in operation. The system down occurred when deleting or disabling the driver.	
Utility does not start up.	<ul style="list-style-type: none"> <li>There is no icon in the start menu of the operating system.</li> <li>The utility does not start up by clicking the icon.</li> </ul>	Page 157 Utility does not startup
The screen or operation is abnormal.	<ul style="list-style-type: none"> <li>The utility screen is not displayed normally.</li> <li>The utility cannot be operated.</li> </ul>	Page 158 The screen or operation is abnormal
The screen for which corrective action is not clear, is displayed.	<ul style="list-style-type: none"> <li>An unexpected screen is displayed.</li> <li>The screen for which corrective action is not clear, is displayed.</li> </ul>	Page 159 The screen for which corrective action is not clear, is displayed.
Personal computer operates slowly.	<ul style="list-style-type: none"> <li>The operation of mouse or keyboard is slow.</li> <li>The operation of other application is slow.</li> <li>CPU utilization of personal computer is high.</li> <li>Operation of sound function is unstable.</li> </ul>	Page 160 Personal computer operates slowly

## Board and driver

Error	Description	Reference
A WDT error occurred.	A hardware failure or a board WDT error has occurred. (RUN LED is OFF.)	Page 160 Hardware error or board WDT error
	A driver WDT error occurred. (RUN LED is flashing and RD LED is ON.)	Page 160 Driver WDT error
Driver does not activate.	The driver cannot communicate with the board. (RUN LED is OFF.)	Page 161 Driver does not start
A bus error occurred.	PCI bus/PCI Express bus error occurred. (RUN LED is flashing and SD LED is ON.)	Page 161 Bus error

## Network access

Error	Description	Reference
An error occurred in the network data link.	The communication error occurred.(ERR.LED is ON/Flashing.)	Page 161 Communication error (ERR. LED is ON/Flashing)
	The user program cannot access CPU modules other than QCPU (Q mode) and MELSEC iQ-R series CPU modules.	Page 162 User program cannot access CPU modules other than QCPU (Q mode) and MELSEC iQ-R series CPU modules
	The board cannot perform communication occasionally while executing a user program.	Page 162 Communication cannot be performed occasionally when executing user program
	Station is disconnected from the network unexpectedly. <ul style="list-style-type: none"> <li>The connected station is disconnected unexpectedly.</li> <li>Data cannot be read from/written to the accessed station.</li> <li>Communication with the accessed station occasionally fails.</li> <li>A relevant station repeats network connection and disconnection.</li> </ul>	Page 162 Station is disconnected
	Communication is unstable. <ul style="list-style-type: none"> <li>The link scan time and transmission delay time is abnormally longer.</li> <li>A timeout occurs during transient transmission.</li> </ul>	Page 163 Communication is unstable
	The station number is duplicated.	Page 163 Station number is duplicated
An error occurred while accessing the device via a network.	The cyclic transmission cannot be performed. <ul style="list-style-type: none"> <li>The output of the own station does not reach the accessed station.</li> <li>The change of the input from the accessed station does not reach the own station.</li> <li>An unexpected value is set to the link device.</li> </ul>	Page 164 Cyclic transmission cannot be performed
	The transient transmission cannot be performed. <ul style="list-style-type: none"> <li>The data cannot be written to the accessed station.</li> <li>The data cannot be read from the accessed station.</li> <li>The data cannot be monitored with the utility.</li> <li>The data cannot be read/written while accessing to the device using a communication function with a user program.</li> </ul>	Page 165 Transient transmission cannot be performed

## 16.2 Troubleshooting for Installation/Uninstallation

The following explains the troubleshooting for error at installation or uninstallation.

### Installation failed

When the installation is aborted or failed, reinstall the utility by the following procedure.

#### Operating procedure

1. Check the installation/uninstallation precautions.  
☞ Page 78 Installation and Uninstallation Precautions
  2. Restart the personal computer.
  3. If the utility can be uninstalled, uninstall it. After the uninstallation, restart the personal computer.  
☞ Page 81 Uninstallation
  4. Install the utility again by following the installation procedure.  
☞ Page 79 Installation procedure, Page 155 Action displayed in the screen is not effective while installation
  5. If the personal computer does not operate normally after the reinstallation, check if the personal computer has any problems.  
☞ Page 167 Checking operation environment, Page 168 Checking personal computer and operating system
- If the problem is not solved by the above corrective actions, refer to the following section and contact us.  
☞ Page 176 Information Required for Inquiries

### Uninstallation failed

When the uninstallation fails, it is necessary to reinstall the software package and then uninstall the utility using the following procedure.

#### Operating procedure

1. Check the installation/uninstallation precautions.  
☞ Page 78 Installation and Uninstallation Precautions
- If the creation of 8.3 filename is disabled, perform the following operation.  
☞ Page 154 Operation for the creation of 8.3 filename is disabled
2. Save the data for installation to the system drive, or insert an installation media to the drive.
  3. Display the "Run" screen from the Start Menu or Quick Access Menu of Windows.
  4. Append option "-A" and execute "Setup.exe" in the installation data.
  5. Install the utility again by following the installation procedure.
  6. Perform the uninstallation.
  7. If the utility cannot be uninstalled normally, check if the personal computer has any problems.  
☞ Page 167 Checking operation environment, Page 168 Checking personal computer and operating system
- If the problem is not solved by the above corrective actions, refer to the following section and contact us.  
☞ Page 176 Information Required for Inquiries

## Operation for the creation of 8.3 filename is disabled

### Operating procedure

1. Enable the creation of 8.3 filename.
2. Save the data for installation to the system drive, or insert an installation media to the drive.
3. Display the "Run" screen from the Start Menu or Quick Access Menu of Windows.
4. Append option "-G" and execute "Setup.exe" in the installation data.
5. Perform the uninstallation.

# Action displayed in the screen is not effective while installation

The following table shows the corrective actions when the screen is displayed.

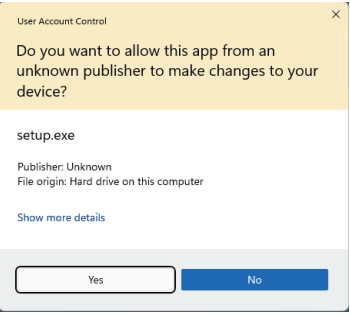
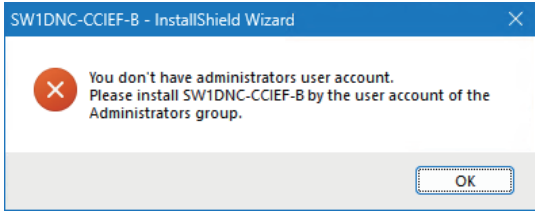
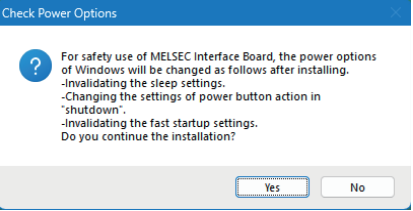
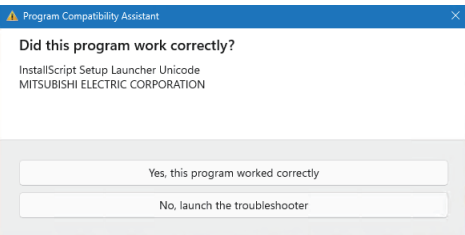
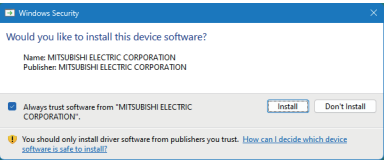
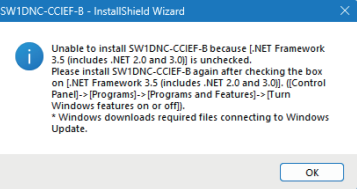
Screens	Procedure
 <p>User Account Control</p> <p>Do you want to allow this app from an unknown publisher to make changes to your device?</p> <p>setup.exe</p> <p>Publisher: Unknown File origin: Hard drive on this computer</p> <p>Show more details</p> <p>Yes No</p>	<p>Appears when the user account control is enabled.</p> <p>Click the [Yes] button.</p>
 <p>SW1DNC-CCIEF-B - InstallShield Wizard</p> <p>You don't have administrators user account. Please install SW1DNC-CCIEF-B by the user account of the Administrators group.</p> <p>OK</p>	<p>Appears when the user account control is disabled and logging on as a user without the administrator authority.</p> <p>Check the user account control settings. (Page 234 Windows User Account Control)</p> <p>Log off, and log on as a user with the administrator authority, then try again.</p>
 <p>Check Power Options</p> <p>For safety use of MELSEC Interface Board, the power options of Windows will be changed as follows after installing.</p> <ul style="list-style-type: none"> <li>-Invalidating the sleep settings.</li> <li>-Changing the settings of power button action in "shutdown".</li> <li>-Invalidating the fast startup settings.</li> </ul> <p>Do you continue the installation?</p> <p>Yes No</p>	<p>Click the [Yes] button.</p> <p>MELSECPowerManager is installed and the Windows Power Options settings are changed automatically.</p> <p>For details on MELSECPowerManager, refer to the following: Page 236 MELSECPowerManager</p>
 <p>Program Compatibility Assistant</p> <p>Did this program work correctly?</p> <p>InstallScript Setup Launcher Unicode MITSUBISHI ELECTRIC CORPORATION</p> <p>Yes, this program worked correctly</p> <p>No, launch the troubleshooter</p>	<p>If this screen appears during or after the installation, click "Yes, this program worked correctly."</p> <p>If this screen appears when the installation is terminated, click the [X] button to close the screen.</p> <p>Do not select "No, launch the troubleshooter." An incorrect module may be installed.</p>
 <p>Windows Security</p> <p>Would you like to install this device software?</p> <p>Name: MITSUBISHI ELECTRIC CORPORATION Publisher: MITSUBISHI ELECTRIC CORPORATION</p> <p>Always trust software from "MITSUBISHI ELECTRIC CORPORATION".</p> <p>Install Don't Install</p> <p>You should only install driver software from publishers you trust. <a href="#">How can I decide which device software is safe to install?</a></p>	<p>Confirm that the publisher is "MITSUBISHI ELECTRIC CORPORATION", and click the [Install] button.</p> <p>This screen may be displayed a couple of times.</p>
 <p>SW1DNC-CCIEF-B - InstallShield Wizard</p> <p>Unable to install SW1DNC-CCIEF-B because [.NET Framework 3.5 (includes .NET 2.0 and 3.0)] is unchecked.</p> <p>Please install SW1DNC-CCIEF-B again after checking the box on [.NET Framework 3.5 (includes .NET 2.0 and 3.0)]. ([Control Panel]-&gt;[Program]-&gt;[Programs and Features]-&gt;[Turn Windows features on or off]).</p> <p>* Windows downloads required files connecting to Windows Update.</p> <p>OK</p>	<p>The message is displayed when the .NET Framework 3.5 (including .NET 2.0 and 3.0) is set to disabled.</p> <p>Reinstall the utility after searching the "Turn Windows features on or off" on the control panel and enabling the function of ".NET Framework 3.5 (including .NET 2.0 and 3.0)".</p> <p>For details on the procedure, refer to the technical bulletin FA-A-0464. Products Confirmed to Operate on Windows 11, and Considerations for Installation</p>

## When the driver is not installed

The driver is installed automatically when installing the board on the personal computer after installing the software package. If the "Found New Hardware Wizard" screen is not displayed automatically after the board installation, update the driver on the Device Manager screen.

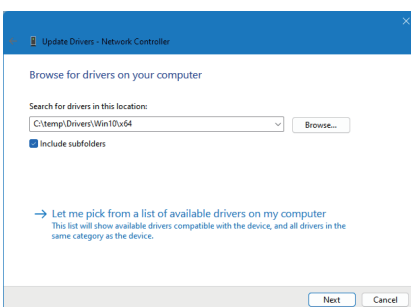
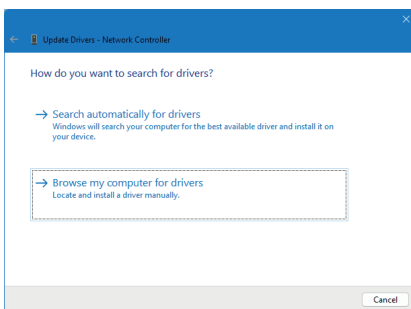
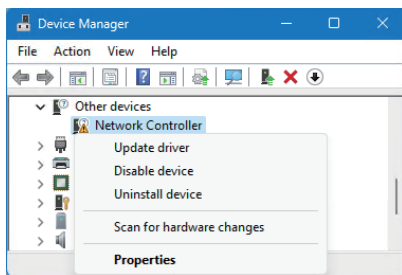

End

1. Open Windows Device Manager, and right-click any of the following then select "Update driver."
  - "MELSEC CC-Link IE Field Device" ⇒ "MELSEC CC-Link IE Field Controller"
  - "MELSEC CC-Link IE Field Device" ⇒ "Network Controller"
  - "Other devices" ⇒ "Network Controller"

2. Click "Browse my computer for drivers."

3. Set either of the following folders of software package for "Search for drivers in this location:."

- For 64-bit version operating system\*1:  
"Drivers\Win10\x64"
- For 32-bit version operating system\*1:  
"Drivers\Win10\x86"

4. Click the [Next] button.

\*1 The operating system can be checked by Windows system information. For details, refer to the Microsoft Knowledge Base. [support.microsoft.com/kb/827218/](https://support.microsoft.com/kb/827218/) (As of July 2024)

If the problem is not solved by the above corrective actions, refer to the following section and contact us.

📄 Page 176 Information Required for Inquiries

# 16.3 Troubleshooting for Personal Computer and Utility

The following shows the troubleshooting for error for operation of a personal computer or utility.

- ☞ Page 157 Personal computer does not start or shuts down
- ☞ Page 157 Utility does not startup
- ☞ Page 158 The screen or operation is abnormal
- ☞ Page 159 The screen for which corrective action is not clear, is displayed.
- ☞ Page 160 Personal computer operates slowly

## Personal computer does not start or shuts down

When the personal computer on which the board is installed does not start, or the system shuts down or system is reset, check the items following the procedure shown below.

### Point

Do not delete or disable the driver in the Windows Device Manager screen when the board is normally recognized. If it is deleted or disabled, the operating system may shut down (blue screen).

### Operating procedure

1. Uninstall the board and check if the personal computer is started.  
☞ Page 168 Checking personal computer and operating system
2. After restarting the personal computer, check if there is any error.  
☞ Page 169 Checking operations with event viewer
3. Install the board and restart the personal computer.  
☞ Page 167 Check the board installation  
☞ Page 168 Checking with Device Manager

If the problem is not solved by the above corrective actions, refer to the following section and contact us.

- ☞ Page 176 Information Required for Inquiries

For the troubleshooting for the specific symptoms, refer to the following section.

## Utility does not startup

When the utility does not startup, check the following items.

Item	Corrective action
Is an error message displayed?	Take corrective action following the message. (☞ Page 159 The screen for which corrective action is not clear, is displayed.)
Is the icon of the utility displayed in the menu of the operating system? Does the utility start by clicking the icon?	The installation is not completed normally. Install the software package. (☞ Page 153 Installation failed)

If the problem is not solved by the above corrective actions, refer to the following section and contact us.

- ☞ Page 176 Information Required for Inquiries

## The screen or operation is abnormal

When the screen is not displayed normally or the software cannot be operated normally, check the following items.

Item	Corrective action
Is an error message displayed?	Take corrective action following the message. (☞ Page 159 The screen for which corrective action is not clear, is displayed.)
Is the display setting correct?	<ul style="list-style-type: none"><li>• Check if the display setting is correct with Device Manager, and install the appropriate display driver.</li><li>• Perform Windows Update</li><li>• Change the hardware acceleration setting in the display setting.</li></ul>
Are other applications being executed?	Close the screens of all other applications.
Is there any error in the personal computer?	<ul style="list-style-type: none"><li>• Check the operating environment. (☞ Page 167 Checking operation environment)</li><li>• Check the personal computer and operating system. (☞ Page 168 Checking personal computer and operating system)</li></ul>

If the problem is not solved by the above corrective actions, refer to the following section and contact us.

☞ Page 176 Information Required for Inquiries

### A manual cannot be displayed from CC IE Field Utility

When a manual cannot be displayed in e-Manual Viewer, end all e-Manual Viewer running and retry the operation.

☞ Page 89 Displaying manuals

### A module is not displayed normally in the CC IE Field configuration window.

If a module is not displayed normally in the CC IE Field configuration window when setting parameters, perform either of the following operations:

- When a profile is deleted in another MELSOFT product, register the deleted profile in the MELSOFT product again.
- Run the MELSOFT Complete Clean Up Tool, and reinstall the software package.

# The screen for which corrective action is not clear, is displayed.

When an unexpected screen is displayed or the corrective action displayed in the screen is not effective, check the following items.

The following table shows the corrective actions when the screen is displayed.

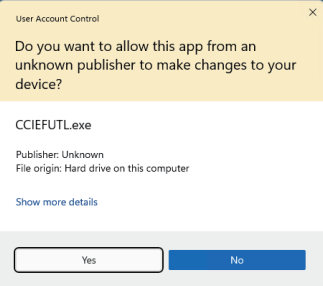
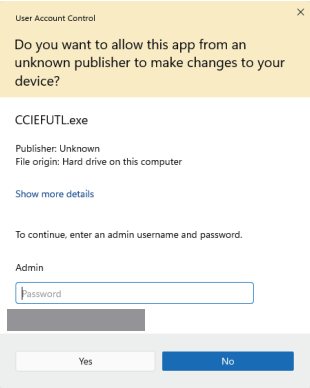
Screens	Corrective action
	<p>Appears when the user account control is enabled. Click the [Yes] button.</p>
<p>The user account control screen in which the password is required to be entered</p> 	<p>Appears when logging on as a user without the administrator authority. Log off, and log on as a user with the administrator authority, then try again.</p>

For error codes, refer to the following:

☞ Page 177 Error Code List

For screens displayed when installing the software package, refer to the following:

☞ Page 155 Action displayed in the screen is not effective while installation

For the screens of the operating system, contact the operating system manufacturer.

For corrective actions related to the screens displayed by a user program, check the user program.

If the problem is not solved by the above corrective actions, refer to the following section and contact us.

☞ Page 176 Information Required for Inquiries

## Personal computer operates slowly

The following explains the troubleshooting when the following symptoms have occurred and operating speed of the personal computer becomes slow.

- The operation of mouse or keyboard is slow.
- The operation of another application is slow.
- CPU utilization of personal computer is high.
- Operation of sound function is unstable.
- When the operating speed of the personal computer becomes slow, check the following items.

Item	Corrective action
Is the CPU utilization of other application high?	<ul style="list-style-type: none"><li>• Start the Windows task manager, and specify the application with high CPU utilization in the [Processes] or [Performance] tab.</li><li>• Reduce the execution frequency of the application with high CPU utilization.</li></ul>
Is the cyclic transmission operation time longer?	<ul style="list-style-type: none"><li>• Adjust the value of link refresh cycle setting. (☞ Page 114 Driver setting)</li><li>• Set the constant link scan. (☞ Page 101 Supplementary setting)</li></ul>
Is the transient transmission operation time longer?	<ul style="list-style-type: none"><li>• Adjust the number of transient transmissions.</li><li>• Reconsider "Event Condition" of the event function. (☞ Page 112 Event setting)</li></ul>

Replace the personal computer if its processing capability is lower for the desired processing.

## 16.4 Troubleshooting for Board and Driver

The following shows the troubleshooting for error for the functions.

- ☞ Page 160 Hardware error or board WDT error
- ☞ Page 160 Driver WDT error
- ☞ Page 161 Driver does not start
- ☞ Page 161 Bus error

### Hardware error or board WDT error

When a hardware error or board WDT error occurs, check the following items.

Item	Corrective action
Is the board installed properly?	Check the board installation status. (☞ Page 167 Check the board installation)
Is the board operating normally on another personal computer?	<ul style="list-style-type: none"><li>• After formatting the HD, install the operating system again.</li><li>• Repair or replace the personal computer.</li></ul>

If the problem is not solved by the above corrective actions, refer to the following section and contact us.

- ☞ Page 176 Information Required for Inquiries

### Driver WDT error

When the driver WDT error occurred, check the following items.

Item	Corrective action
Has the error occurred due to a temporary system overload ?*1	<ul style="list-style-type: none"><li>• Reset the board. (☞ Page 122 Resetting Board)</li><li>• Restart the personal computer.</li></ul>
Has the same error occurred repeatedly? (Is the system overloaded constantly?)	<ul style="list-style-type: none"><li>• Remove the factor of system overload.</li><li>• Disable the driver WDT function or increase the driver WDT monitoring time. (☞ Page 114 Driver setting)</li></ul>

- \*1 A driver WDT error may occur when the system is overloaded temporarily due to the following factors.
- Windows start processing at the personal computer startup.
  - Operation of a device driver such as a graphic board.
  - Operation of other software applications.

If the problem is not solved by the above corrective actions, refer to the following section and contact us.

- ☞ Page 176 Information Required for Inquiries

## Driver does not start

When the driver does not start normally, check the following items.

Item	Corrective action
Is the board installed properly?	Check the board installation status. (☞ Page 167 Check the board installation)
Is the channel number set properly?	Check the channel number. (☞ Page 170 Checking channel numbers)
Is the software package installed?	Reinstall the software package. (☞ Page 153 Installation failed)

If the problem is not solved by the above corrective actions, refer to the following section and contact us.

☞ Page 176 Information Required for Inquiries

## Bus error

When a bus error occurs, check the following items.

Item	Corrective action
Is the board installed properly?	Check the board installation status. (☞ Page 167 Check the board installation)
Is the board operating normally on another personal computer?	<ul style="list-style-type: none"><li>• After formatting the HD, install the operating system again.</li><li>• Repair or replace the personal computer.</li></ul>

If the problem is not solved by the above corrective actions, refer to the following section and contact us.

☞ Page 176 Information Required for Inquiries

# 16.5 Troubleshooting for Data Link

The following shows the troubleshooting for error for the data link on the network.

☞ Page 161 Communication error (ERR. LED is ON/Flashing)

☞ Page 162 User program cannot access CPU modules other than QCPU (Q mode) and MELSEC iQ-R series CPU modules

☞ Page 162 Communication cannot be performed occasionally when executing user program

☞ Page 162 Station is disconnected

☞ Page 163 Communication is unstable

☞ Page 163 Station number is duplicated

## Communication error (ERR. LED is ON/Flashing)

When the ERR.LED is ON/flashing due to the communication error, check the following items.

### ERR.LED is ON

One of the following error occurred.

- An error is detected in all stations.
- Stations with same station number exist on the network.
- Network parameters are corrupted.
- Network parameters do not match the installation status. (Reserved station specification, number of connected stations, network number etc.)

Check the following items.

Item	Corrective action
Is the network parameter set according to the actual board installation status?	Check the parameter settings. (☞ Page 98 Setting Network Parameter)
Has a board error occurred?	Perform the board test. (☞ Page 170 Checking operations with board diagnostics)
Is the board hardware operating normally?	Perform the board standalone test. (☞ Page 171 Board test)

If the problem is not solved by the above corrective actions, refer to the following section and contact us.

☞ Page 176 Information Required for Inquiries

## ERR.LED is flashing

The error station is detected. Check the following items.

Item	Corrective action
Is a disconnected station displayed in the network configuration of the CC-Link IE Field Network diagnostics? ( <a href="#">Page 128</a> Displaying diagnostics screen)	Perform a troubleshooting on the disconnected station for when D LINK LED is OFF or flashing. ( <a href="#">Page 172</a> D LINK LED is turned OFF or flashing)
"Total stations" set for network parameter of the master station is different from the number of device stations connected to the network.	Correct "Total stations" to match with the number of device stations.

If the problem is not solved by the above corrective actions, refer to the following section and contact us.

[Page 176](#) Information Required for Inquiries

## User program cannot access CPU modules other than QCPU (Q mode) and MELSEC iQ-R series CPU modules

The 64-bit version user program cannot access CPU modules other than QCPU (Q mode) and MELSEC iQ-R series CPU modules.

Use 32-bit version user program.

## Communication cannot be performed occasionally when executing user program

When the communication cannot be performed occasionally when executing a user program, check the following items.

Item	Corrective action
Is the error code returned to the user program?	Check the returned value of the communication function. ( <a href="#">Page 177</a> Error Code List)
Can the network error be monitored with utility?	Check the network status with the utility. ( <a href="#">Page 174</a> Checking network status with CC-Link IE Field Network diagnostics)
Does the same error occur when adding the station to the system?	Check if the same error occurs when adding the station in order next to the existing station for the system configuration which is configured only by a master station and own station. If the same error has occurred, check the added station. <ul style="list-style-type: none"><li><a href="#">Page 167</a> Checking installation environment</li><li><a href="#">Page 167</a> Checking cables and wiring</li><li><a href="#">Page 171</a> Board test</li></ul>

If the problem is not solved by the above corrective actions, refer to the following section and contact us.

[Page 176](#) Information Required for Inquiries

## Station is disconnected

The following explains the troubleshooting when the following symptoms have occurred and the station is disconnected.

- The connected station is disconnected unexpectedly.
- Data cannot be read from/written to the accessed station.
- Communication with the accessed station occasionally fails.
- A relevant station repeats network connection and disconnection

When the station is disconnected, check the following items.



Item	Corrective action
Is there influence of ambient temperature or noise?	Check the installation environment. ( <a href="#">Page 167</a> Checking installation environment)
Is there an error in the cable or hub? Is the wiring proper?	Check the cables and wiring. ( <a href="#">Page 167</a> Checking cables and wiring)

If the problem is not solved by the above corrective actions, refer to the following section and contact us.

[Page 176](#) Information Required for Inquiries

## Communication is unstable

When the link scan time and transmission delay time is abnormally longer or a timeout occurs during transient transmission, check the following items.

Item	Corrective action
Is there influence of ambient temperature or noise?	Check the installation environment. (  Page 167 Checking installation environment)
Is the L ERR. LED of the master or device station ON?	Check the LED and take corrective action in the case of L ERR. LED turned ON. (  Page 173 L ERR. LED/L ER LED is turned ON)
Does the error occur on the "Selected Station Communication Status Monitor" screen in CC-Link IE Field Network diagnostics?	When an error occurred on PORT1 and PORT2 , perform cable and self loopback tests. (  Page 53 Cable test, Page 47 Self-loopback test)

If the problem is not solved by the above corrective actions, refer to the following section and contact us.

 Page 176 Information Required for Inquiries

## Station number is duplicated

When the station number is duplicated, check the following items.

Item	Corrective action
Is the station number duplicated with any of other stations?	Change the duplicated station number.
Are any stations other than those to be replaced disconnected when replacing device stations?	Perform either of the following operations. <ul style="list-style-type: none"><li>• Click the [Update] button in the diagnostics screen of CC-Link IE Field Network. (  Page 128 Displaying diagnostics screen)</li><li>• Reset the master station or power OFF and ON.</li></ul>
Is the connection position changed when replacing device stations?	
Are device stations connected to the same network replaced with each other?	After performing the above operations, reset the device station with the duplicated station number or power OFF and ON.

If the problem is not solved by the above corrective actions, refer to the following section and contact us.

 Page 176 Information Required for Inquiries

# 16.6 Troubleshooting for Device Access

The following shows the troubleshooting when an error has occurred in the network data link.

☞ Page 164 Cyclic transmission cannot be performed

☞ Page 165 Transient transmission cannot be performed

## Cyclic transmission cannot be performed

The following explains the troubleshooting when the following symptoms have occurred and the cyclic transmission cannot be performed.

- The output of the own station does not reach the accessed station.
- The change of the input from the accessed station does not reach the own station.
- An unexpected value is set to the link device.

When cyclic data are not delivered to the master or a device station, check the following items.

Item	Corrective action
Is the D LINK LED of the master or device station ON?	If the D LINK LED is flashing or OFF, perform the troubleshooting. (☞ Page 172 D LINK LED is turned OFF or flashing)
In "Network Configuration Setting" of the master station, is a device station specified as a reserved station?	Cancel the reserved station setting of the device station. (☞ Page 100 Network configuration setting)
In "Network Configuration Setting" of the master station, is "RX/R Y Setting" or "RWw/RWr Setting" for device stations configured?	Set RX/R Y or RWw/RWr data for each device station within the allowable range. (☞ Page 100 Network configuration setting)
Do the station numbers set in "Network Configuration Setting" of the master station match those set for corresponding device stations?	Correct the station number(s).
Do the station types set in "Network Configuration Setting" of the master station match those set for the connected device stations?	Correct the station types set in "Network Configuration Setting" of the master station.
Is the station number of CC-Link IE Field Network board duplicated with the station number of other station?	Change the duplicated station number.
Is the board hardware operating normally?	Perform the board test. (☞ Page 171 Board test)

If the problem is not solved by the above corrective actions, refer to the following section and contact us.

☞ Page 176 Information Required for Inquiries

For the troubleshooting for the specific symptoms, refer to the following:

### An unexpected value is set to the specific link device

Check the following items.

Item	Corrective action
Is there a link error station?	Check the network condition by CC-Link IE Field Network diagnostics. (☞ Page 174 Checking network status with CC-Link IE Field Network diagnostics)
Is the parameter assignment range correct?	Check the "Network Configuration Setting" of the master station. (☞ Page 100 Network configuration setting)
Is the link device accessed using a user program?	Check the argument of the communication function accessing to the link device.
Is the link device accessed from a sequencer in the network?	Check the device range used in the sequence program.

## Transient transmission cannot be performed

The following explains the troubleshooting when the following symptoms have occurred and the transient transmission cannot be performed.

- The data cannot be written to the accessed station.
- The data cannot be read from the accessed station.
- The data cannot be monitored with the utility.
- The data cannot be read/written while accessing to the device using a communication function with a user program.

When transient transmissions cannot be executed to the target station, check the following items.

Item	Corrective action
Is the D LINK LED of the master or device station ON or flashing?	If the D LINK LED is OFF, perform the troubleshooting. (☞ Page 172 D LINK LED is turned OFF or flashing)
Is the baton passing status of the target station normal?	In the CC-Link IE Field Network diagnostics, identify the cause of the error and perform the corrective action. (☞ Page 127 Diagnosing CC-Link IE Field Network)
Is the station number of CC-Link IE Field Network board duplicated with the station number of other station?	Change the duplicated station number.
Is the Communication test result normal? (☞ Page 54 Communication test)	In the CC-Link IE Field Network diagnostics, identify the cause of the error and perform the corrective action. (☞ Page 127 Diagnosing CC-Link IE Field Network)
Is the MD function argument correct? • Is the target station's network number correct? • Is the target station number correct?	Check the MD function argument.
Is the board hardware operating normally?	Perform the board test. (☞ Page 171 Board test)

If the problem is not solved by the above corrective actions, refer to the following section and contact us.

☞ Page 176 Information Required for Inquiries

# 16.7 Checking method

---

The following shows the checking methods of the board.



## Checking with eyesight

---

Check the appearance of the device and connection status.



### ■Checking the installation and wiring

Check if the installation and wiring are performed within the range of the specification.

-  Page 167 Checking installation environment
-  Page 167 Check the board installation
-  Page 167 Checking cables and wiring

### ■Checking the board appearance

The board status and network status can be checked by MODE LED or switch setting.

-  Page 171 Checking LED status
-  Page 170 Checking channel numbers



## Checking the error

---

Check the screen displayed on a personal computer.







### ■Checking with the operating system

The driver operation status can be checked with Device Manager or event viewer.

-  Page 168 Checking personal computer and operating system
-  Page 168 Checking with Device Manager
-  Page 169 Checking operations with event viewer

### ■Checking with the utility

The board status and network status can be checked with the utility.

-  Page 170 Checking channel numbers
-  Page 170 Checking operations with board diagnostics
-  Page 171 Checking operations with tests
-  Page 171 Checking LED status
- Checking network status with CC-Link IE Field Network diagnostics:  Page 174 Checking network status with CC-Link IE Field Network diagnostics
-  Page 174 Checking network status with monitoring link special relays (SB) and link special registers (SW)
-  Page 175 Checking communication status with monitoring access target device

## Checking installation environment

Check if the installation environment is within the general specification or clear from noise.

 Page 33 General Specifications

Item	Corrective action
Is the ambient temperature within the specified range?	Keep the ambient temperature within the specified range by taking action such as removing heat source.
Is there any noise affecting the system?	Check the wire and cable lengths and grounding condition of each device, and take measures against noise. (  Page 38 PROCEDURE BEFORE OPERATION)



## Check the board installation

Check the board for an abnormal installation.

Item	Corrective action
Is the board installed properly?	<ul style="list-style-type: none"> <li>Remove the board and reinstall it.</li> <li>Change the installation location of the board.</li> <li>Fix the board firmly with screws.</li> </ul>
Is the applicable number of boards installed?	Remove the board which exceeds the maximum number of applicable boards.





## Checking cables and wiring

Check if there is an error in the cable or hub, disconnected connectors, or improper wiring.

Item	Corrective action
Is a specifications compliant Ethernet cable used?	Replace the cable with a specifications compliant Ethernet cable. (  Page 29 Cables)
Is the station-to-station distance 100m or less?	Change the station-to-station distance to 100m or less.
Does the cabling condition (bend radius) meet the specification?	Refer to the manual for the Ethernet cable, and correct the bend radius.
Is any Ethernet cable disconnected?	Replace the Ethernet cable.
Is the switching hub normal?	<ul style="list-style-type: none"> <li>Check if the 1000BASE-T-compliant switching hub is used. ( Page 29 Hubs)</li> <li>Power OFF and then ON the switching hub.</li> <li>Replace the switching hub.</li> </ul>

## Checking operation environment

Check if the supported operating system and functions are used.

Item	Corrective action
Is the operating system written in "Operating Environment" used? (  Page 30 Operating Environment)	Use a personal computer on which the supported operating system is installed.
Is a programming language written in Operating Environment used for a user program using MELSEC data link library? (  Page 30 Operating Environment)	<ul style="list-style-type: none"> <li>Create a user program using a supported programming language.</li> <li>For precautions when using MELSEC data link library, refer to the following manual.  MELSEC Data Link Library Reference Manual</li> </ul>
Are the functions written in "The functions cannot be used" in "Operating Environment" set? (  Page 30 Operating Environment)	Change the settings for the unsupported functions.
Is the administrator authority used for logging on to a personal computer?	Log on as a user with the administrator authority.

## Checking personal computer and operating system

Check if the personal computer or operating system has any problem.

Item	Corrective action
Is the power supply ensured?	Check the power outlet and power cable of the personal computer.
Does the board operate normally if the other optional boards are uninstalled?	<ul style="list-style-type: none"> <li>• Change the installation location of the board.</li> <li>• Check the resource acquisition status of other board and change the resource in the BIOS setting screen or Device Manager screen.</li> <li>• Reinstall the driver of the other optional boards.</li> <li>• Replace the other optional boards.</li> </ul>
Is the board operating normally on another personal computer?	<ul style="list-style-type: none"> <li>• After formatting the HD, install the operating system again.</li> <li>• Repair or replace the personal computer.</li> </ul>

For the problem of the personal computer or operating system, consult the personal computer or operating system manufacturer.

## Checking with Device Manager

Check if the board is displayed on the Windows Device Manager.

Item	Corrective action
Is the driver name of the board not displayed in the Device Manager screen?	<p>The board or driver is not installed.</p> <ul style="list-style-type: none"> <li>• If the board is not installed, install the board.</li> <li>• If the board is already installed, check the board installation status and reinstall the board.</li> <li>• Reinstall the software package. (☞ Page 153 Installation failed)</li> <li>• If the board operates normally on another personal computer, the personal computer may have problems. In this case, repair or replace the personal computer.</li> <li>• If the board does not operate normally on another personal computer, replace the board.</li> </ul>
Is "!" displayed next to the icon of driver for board in the Device Manager screen?	<p>The driver installation failed, or the driver did not start normally.</p> <ul style="list-style-type: none"> <li>• Reinstall the software package. (☞ Page 153 Installation failed)</li> <li>• Check the board installation status and reinstall the board.</li> <li>• If the board operates normally on another personal computer, the personal computer may have problems. In this case, repair or replace the personal computer.</li> <li>• If the board does not operate normally on another personal computer, replace the board.</li> </ul>
Is "Code 52" displayed on the "General" tab as the device status in the properties with "!" displayed next to the icon of driver for board in the Device Manager screen?	<p>The driver signature verification failed.</p> <ul style="list-style-type: none"> <li>• Set the "Date &amp; time" in the Windows settings, to the date after the "Original Install Date" of Windows, and then reinstall the software package. "Original Install Date" can be checked by running "systeminfo" at the command prompt.</li> </ul>

If the problem is not solved by the above corrective actions, refer to the following section and contact us.

☞ Page 176 Information Required for Inquiries

### Point

- Do not uninstall or disable the driver of the board on the Device Manager when the board is normally recognized. If it is uninstalled or disabled, the operating system may shut down (blue screen).
- "?" is displayed next to the icon, however, the CC-Link IE Field Network board is recognized normally.

# Checking operations with event viewer

Check the operations of the board with the Windows event viewer.

## For error events

Errors occurred in the driver are displayed in the system log of the event viewer.

Errors related to the CC-Link IE Field Network board are displayed as "Mccief" in the source field of the event viewer.

The following explains error messages and their corrective actions.



For multiple errors, check the occurrence order (occurrence time) in the event viewer screen and perform corrective actions from the first error that occurred.

Event ID	Error message	Corrective action
256 (0100H)	Because the error had occurred in the during starting of the device, the device was not able to be executed.	<ul style="list-style-type: none"> <li>Reinstall the software package.</li> <li>Check the board installation status. (☞ Page 167 Check the board installation)</li> <li>If the board operates normally on another personal computer, the personal computer may have problems. In this case, repair or replace the personal computer.</li> <li>If the error occurs on another personal computer, replace the board.</li> </ul> If any of the above actions do not solve the error, reinstall the operating system.
258 (0102H)	Time-out was detected while accessing the board.	<ul style="list-style-type: none"> <li>Restart the personal computer.</li> <li>Check the board installation status. (☞ Page 167 Check the board installation)</li> <li>If the board operates normally on another personal computer, the personal computer may have problems. In this case, repair or replace the personal computer.</li> <li>If the error occurs on another personal computer, replace the board.</li> </ul> If any of the above actions do not solve the error, please contact your local Mitsubishi Electric sales office or representative.
259 (0103H)	The board more than the maximum number of sheets which was able to be installed was detected.	Remove the board which exceeds the maximum number of applicable boards.
279 (0117H)	An error occurred when Registry Database wrote out.	<ul style="list-style-type: none"> <li>Restart the personal computer after installing the software package, and check if the error does not occur.</li> <li>Increase the system memory and disk capacity.</li> <li>When the error has occurred at upgrading or updating the operating system with the software package installed, reinstall the software package.</li> </ul>
280 (0118H)	Own station received the request which was not processable from another station.	Check the board which is commanding a process and check the program in the programmable controller CPU.
286 (011EH)	Failed to allocate the Memory Area.	Expand the memory in the personal computer.
287 (011FH)	The parameter is not set to the board. Otherwise, the parameter set to the board is broken.	Set parameters in the utility and reset the board.
288 (0120H)	Driver WDT error had occurred.	Refer to the corrective action when the driver WDT error occurred. (☞ Page 160 Driver WDT error)
295 (0127H)	The Board WDT error had occurred.	Refer to the troubleshooting when the board WDT error occurred. (☞ Page 160 Hardware error or board WDT error)
296 (0128H)	Board error was detected by the hardware self-diagnosis.	<ul style="list-style-type: none"> <li>Restart the personal computer.</li> <li>Refer to the troubleshooting when the Hardware error occurred. (☞ Page 160 Hardware error or board WDT error)</li> </ul>
304 (0130H)		
305 (0131H)	Shift to the sleep, the hibernate, or the fast startup was detected. Because of the board supports neither the sleep nor the hibernate nor the fast startup, it does not operate normally.	Change the power option not to entering the sleep mode, hibernation mode, or enabling fast startup and restart the personal computer.
306 (0132H)	Detect "surprise removal". Please make sure of the installation of the interface board and the state of computer. (Channel:18x,Mcciefx,Busxx)	<ul style="list-style-type: none"> <li>Check the board installation status, and reinstall the board after shutdown in case of an abnormal installation.</li> <li>Check the personal computer operating status, and repair or replace the personal computer in case of an abnormal operation.</li> <li>If an error occurred while using ftServer, consult Stratus Technologies, Inc.</li> </ul>

Event ID	Error message	Corrective action
539 (021BH)	Board error was detected by the hardware self-diagnosis.	<ul style="list-style-type: none"> <li>Restart the personal computer.</li> <li>Refer to the troubleshooting when the Hardware error occurred. (☞ Page 160 Hardware error or board WDT error)</li> </ul>
540 (021CH)		
541 (021DH)		
542 (021EH)		
543 (021FH)		

## For information events

The following information event logs other than errors are displayed in the system log of the event viewer. The corrective actions are not required for the following events.

Event ID	Description	Output timing
1024 (0400H)	Driver started normally. (Channel:18x,Mcciefx,Busxx)	At driver startup
1025 (0401H)	Board reset was executed.	At board reset (Except for board reset at driver startup)
1026 (0402H)	Network parameter was updated.	At common parameter transmission by master station
1027 (0403H)	State information was updated.	At driver operation log update

## Checking channel numbers

Check if the channel numbers are properly assigned to the boards in the "Channel No. Setting" screen.

☞ Page 120 Setting Board Channel Numbers

Item	Corrective action
Are all installed boards displayed?	<ul style="list-style-type: none"> <li>Check the Device Manager screen. (☞ Page 168 Checking with Device Manager)</li> <li>Check the Event Viewer screen. (☞ Page 169 Checking operations with event viewer)</li> </ul>
Are channel numbers duplicated?	Set channel numbers so that they are not duplicated.

## Checking operations with board diagnostics

Check the contents displayed in the board list in the "Board Diagnostics" screen.

☞ Page 125 Diagnosing Board

Item	Corrective action
Are all installed boards displayed?	Check the channel numbers. (☞ Page 170 Checking channel numbers)
Has a board error occurred?	Check the error code and perform the corrective action described in the error code list. (☞ Page 177 Error Code List)

## Checking operations with tests

### Board test

Check for hardware errors by performing board tests in the "Board Diagnostics" screen.

☞ Page 125 Diagnosing Board

Item	Description	Reference
Bus I/F test	Check the hardware related to the bus I/F function of the CC-Link IE Field Network board.	Page 45 Bus I/F test
Memory test	Check the memory of the CC-Link IE Field Network board.	Page 45 Memory test
Hardware test	Check the hardware in the CC-Link IE Field Network board.	Page 46 Hardware test
Self-loopback test	Check the communication circuit of the transmission system of the CC-Link IE Field Network board.	Page 47 Self-loopback test

For module test other than boards, refer to the manuals of each module.

### Network tests

Perform tests in the "Board Diagnostics" screen or the "CC IE Field Diagnostics" screen to check for errors in the connection status or settings of the network.

☞ Page 125 Diagnosing Board, Page 127 Diagnosing CC-Link IE Field Network

Item	Corrective action	Reference
Loop test	Check the network circuit status and parameter setting status of each station.	Page 52 Loop test
Cable test	Check the connection status of the Ethernet cable.	Page 53 Cable test
Communication test	Check whether the communication path for transient transmission from the own station to the target station is correct.	Page 54 Communication test

16

## Checking LED status

The LED status can also be checked by the LED display in the "CC IE Field Diagnostics" screen, other than checking the board visually.

☞ Page 136 Selected station communication status monitor

When using the software package version 1.04E or later, the LED status of MODE, D LINK, and L ERR cannot be confirmed in the "CC IE Field diagnostics" screen. Confirm the LED status with the value stored in the following link special relays (SB) and link special registers (SW).

LED	Status	SB/SW
MODE	ON	The value of SW0043 is '0' or '1'.
	Flash	The value of SW0043 is '2'
	OFF	The value of SW0043 is '6', '7', or '9'.
D LINK	ON	SB0049 is OFF
	Flash	SB0049 is ON and SB0047 is OFF
	OFF	SB0049 is ON and SB0047 is ON
L ERR	ON	SB006C is ON or SB006D is ON
	OFF	SB006C is OFF and SB006D is OFF

Check the LED status and take the corresponding corrective actions.

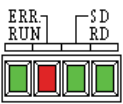
LED	Status				Description	Reference
	RUN	ERR.	SD	RD		
	ON	OFF	OFF	OFF	Operating normally. (Data send/receive is not performed.)	Corrective action unnecessary
	ON	OFF	ON	—	Operating normally. (Sending data)	
	ON	OFF	—	ON	Operating normally. (Receiving data)	
	ON	ON/Flash	—	—	Communication error has occurred.	Page 161 Communication error (ERR. LED is ON/Flashing)
	OFF	OFF	OFF	OFF	A hardware failure or a board WDT error has occurred.	Page 160 Hardware error or board WDT error
					The driver is not started.	Page 161 Driver does not start
	Flash	—	—	ON	Driver WDT error has occurred.	Page 160 Driver WDT error
	Flash	ON	—	—	PCI bus/PCI Express bus error has occurred.	Page 161 Bus error

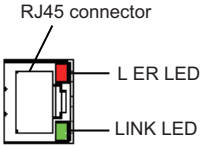
LED	Status		Description	Reference
P1, P2 	L ER	OFF	Operating normally.	Corrective action unnecessary
	LINK	ON	<ul style="list-style-type: none"> <li>The module received normal data.</li> <li>The board does not perform loopback.</li> <li>Linkup in progress.</li> </ul>	
	L ER	ON	<ul style="list-style-type: none"> <li>The module received abnormal data.</li> <li>The board is performing loopback.</li> </ul>	Page 173 L ERR. LED/L ER LED is turned ON
	LINK	OFF	Linkdown in progress.	Page 173 LINK LED is turned OFF

If the LED does not turn ON in synchronization with the utility display or execution status of the board, LED failure may occur. In this case, replace the board.

## MODE LED is turned OFF or flashing

MODE LED is an LED which does not exist on the board. Check the status with the LED display in the "CC IE Field Diagnostics" screen. (☞ Page 136 Selected station communication status monitor)

When the MODE LED is turned OFF, it is in the offline mode. When the MODE LED is flashing, it is in the test mode.

Item	Corrective action
Is the mode set to the online mode?	Change the mode to the online mode. (☞ Page 98 Setting Network Parameter)
Is the board hardware operating normally?	Perform the board test. (☞ Page 171 Board test)

## D LINK LED is turned OFF or flashing

D LINK LED is an LED which does not exist on the board. Check the status with the LED display in the "CC IE Field Diagnostics" screen. (☞ Page 136 Selected station communication status monitor)

When the D LINK LED is turned OFF, both cyclic transmission and transient transmission of the board are stopped.

When the D LINK LED is flashing, the cyclic transmission of the board is stopped, or communication route is consecutively built because the network communication route is unstable.

Item	Corrective action
Is the master station connected to the network and operating normally?	<ul style="list-style-type: none"> <li>If an error has occurred in the master station, solve the error.</li> <li>Check if the master station is performing data link with CC-Link IE Field Network diagnostics, and perform the corrective action. (☞ Page 127 Diagnosing CC-Link IE Field Network)</li> <li>When the master station and submaster station are modules other than the MELSEC iQ-R series, and a local station of the MELSEC iQ-R series module is used, refer to the following: (☞ Page 28 Precautions for when connecting the MELSEC iQ-R series module)</li> </ul>
Are the connected other stations normal?	Check if the other station's power is turned ON.
Are cables and wiring normal?	<ul style="list-style-type: none"> <li>Check the cables and wiring. (☞ Page 167 Checking cables and wiring)</li> <li>Perform a loop test. (☞ Page 52 Loop test)</li> <li>Perform a cable test. (☞ Page 53 Cable test)</li> </ul>
Is the loopback function enabled for the master station?	Configure a ring topology without connecting the switching hub.

Item	Corrective action
Check for any of the following wiring conditions. <ul style="list-style-type: none"> <li>• Connecting both PORT1 and PORT2 to the switching hub</li> <li>• Although the loopback function is disabled, the network is configured in ring topology.</li> <li>• Although the loopback function is enabled, the network is configured in star topology.</li> <li>• The network is incorrectly configured in ring topology.</li> </ul>	Correct the wiring. (☞ Page 19 Single network system) <The system does not contain a switching hub.> <ul style="list-style-type: none"> <li>• When not using the loopback function Disconnect an Ethernet cable connected to any stations on the network (either PORT1 or PORT2).The network topology will become a line topology and data link will start.</li> <li>• When using the loopback function Enable the loopback function and rewrite the network parameter. (☞ Page 76 Loopback Function)</li> </ul> <The system contains a switching hub.> <ul style="list-style-type: none"> <li>• Check if the loopback function setting is correctly configured. (☞ Page 76 Loopback Function) If incorrect, correct the network parameter and rewrite it. When data link starts over the network, the action is successful.</li> <li>• Disconnect one Ethernet cable connected to the switching hub and power OFF and then ON the hub. (Repeat this operation until data link starts over the network.)</li> <li>• When data link starts over the network, check the network configuration by CC-Link IE Field Network diagnostics. (☞ Page 127 Diagnosing CC-Link IE Field Network)</li> </ul>
Is the station number duplicated with any of other stations?	Change the duplicated station number.
Is the board hardware operating normally?	Perform the board test. (☞ Page 171 Board test)

## L ERR. LED/L ER LED is turned ON

An error has occurred due to received data or loop. The L ER LED of the PORT which detected the error is turned ON. The error detail can be checked with the CC-Link IE Field Network diagnostics. (☞ Page 128 Displaying diagnostics screen)  
L ERR. LED is turned OFF automatically when a normal data is received or the loopback function is not performed in a ring topology.

Item	Corrective action
Are cables and wiring normal?	<ul style="list-style-type: none"> <li>• Check the cables and wiring. (☞ Page 167 Checking cables and wiring)</li> <li>• Perform a cable test. (☞ Page 53 Cable test)</li> </ul>
Are the connected other stations normal?	Check if the other station's power is turned ON.
Is the master station set to online mode?	Change the mode of the master station to online. (☞ Page 98 Setting Network Parameter)
Is the installation environment within the specifications? Is there any noise influence?	Check the installation environment. (☞ Page 167 Checking installation environment)
Is the loopback function enabled for the master station?	When the loopback function is enabled, check if the ring topology is correctly configured for the port where the L ER LED is on. (☞ Page 24 Configuration in which data link cannot be performed (incorrect ring topology))
Is the board hardware operating normally?	Perform the board test. (☞ Page 171 Board test)

## LINK LED is turned OFF







This indicates a status in which the board can not communicate (link down).

Item	Corrective action
Are cables and wiring normal?	<ul style="list-style-type: none"> <li>• Check the cables and wiring. (☞ Page 167 Checking cables and wiring)</li> <li>• Perform a cable test. (☞ Page 53 Cable test)</li> </ul>
Are the connected other stations normal?	Check if the other station's power is turned ON.
Is the board hardware operating normally?	Perform the board test. (☞ Page 171 Board test)

## Checking network status with CC-Link IE Field Network diagnostics





Check the network condition in the "CC IE Field Diagnostics" screen.

 Page 128 Displaying diagnostics screen

Item	Corrective action
Are all installed boards displayed in the "Select Diagnostics Destination" screen? (  Page 128 Selecting diagnostics target board)	Check the channel numbers. (  Page 170 Checking channel numbers)
Is an error displayed on the network configuration diagram?	Check the details of the communication error on the "Selected Station Communication Status Monitor" screen. (Perform the troubleshooting described in the "Error details" screen.) (  Page 136 Selected station communication status monitor)
Are details of the error station selected on the network configuration diagram displayed on the "Selected Station Communication Status Monitor" screen?	Click the button displayed when an error occurs in the "Selected Station Communication Status Monitor" screen and perform the troubleshooting described in the "Error details" screen. (  Page 136 Selected station communication status monitor) The following are the causes for when details of the error station are not displayed. <ul style="list-style-type: none"> <li>• Master station duplication</li> <li>• Station number duplication</li> <li>• Device station type error</li> </ul> Check the "Board Diagnostics" screen and identify the cause of the error. (  Page 125 Diagnosing Board) If the error station is a module, identify the cause of the error with System Monitor of GX Works2.
Is there any error log in the "Network Event History" screen? (  Page 141 Network event history)	Check the detailed information and identify the cause of the error.

## Checking network status with monitoring link special relays (SB) and link special registers (SW)

Check link special relays (SB) and link special registers (SW) with Device Monitor Utility.

Item	Corrective action
Is SB0047 (Baton pass status (own station)) faulty (ON)?	Perform the troubleshooting for when the transient transmission cannot be performed at own station. (  Page 165 Transient transmission cannot be performed)
Is SW00A0 to SW00A7 (Baton pass status (each station)) faulty (ON)?	Perform the troubleshooting for when the transient transmission cannot be performed at station in which baton pass error has occurred. (  Page 165 Transient transmission cannot be performed)
Is SB0049 (Data link status (own station)) faulty (ON)?	Perform the troubleshooting for when the cyclic transmission cannot be performed at own station. (  Page 164 Cyclic transmission cannot be performed)
Is there a cyclic transmission error station in SW00B0 to SW00B7 (Data link status (each station))?	Perform the troubleshooting for when the cyclic transmission cannot be performed at station in which data link error has occurred. (  Page 164 Cyclic transmission cannot be performed)
Is SB004A/SB004B (Own station's CPU status (1)/Own station's CPU status (2)) faulty (ON)?	Check the Windows event viewer. (  Page 169 Checking operations with event viewer)
Is there an error station in SW0100 to SW0107/SW0110 to SW0117 (Operation status (each station) (1)(2))?	Refer to the CPU module manual regarding the CPU of the station in which a CPU Stop error/Continuation error has occurred, perform the troubleshooting of the CPU module.

For Device Monitor Utility, refer to the following:

 MELSEC Data Link Library Reference Manual



For link special relays (SB) and link special registers (SW), refer to the following:

 Page 198 Link Special Relay (SB) List, Page 209 Link Special Register (SW) List

# Checking communication status with monitoring access target device

Monitor the link device and access target device with Device Monitor Utility.

Check whether the system is performing as set on the parameters and programs by checking the performance of link device communication, or transient transmission/reception.

Item	Corrective action
An error message is displayed.	<ul style="list-style-type: none"><li>• Take corrective action following the message.</li><li>• Check the error code and perform the corrective action described in the error code list. (  Page 177 Error Code List)</li></ul>
Is an unexpected value set to the link device?	Take corrective action for when an unexpected value is set to the link device.(  Page 164 An unexpected value is set to the specific link device)
Is the device able to be written with Device Monitor Utility?	Check the user program when the access can be performed normally with Device Monitor Utility.

For Device Monitor Utility, refer to the following:

 MELSEC Data Link Library Reference Manual

# 16.8 Information Required for Inquiries

When the troubleshooting cannot solve the problem, or a board failure occurs, please contact your local Mitsubishi Electric sales office or representative.

Inform the following conditions and situations when inquiring the problems.

Product information			
Item		Condition/Situation	Reference
Product version	Board	Model: Q80BD-J71GF11-T2/Q81BD-J71GF11-T2 Rating plate: _____-_ Product information: _____-_	Page 232 Checking Serial Number and Function Version
	Utility	Model: SW1DNC-CCIEF-( ) Version: _._ _	Page 89 Help Function
Personal computer	Personal computer name	Manufacturer: Personal computer name:	Page 30 Operating Environment
	CPU	(Example: Intel® Core™2 Duo Processor 3GHz)	
	Memory size		
	OS	(Example: Windows 11 Professional)	
Other option boards	Existence	(If exists, type, the number of boards and so on)	—
	Situation checked with disconnecting other option boards		—

Failure content	
Item	Condition/Situation
Failure description	(Example: The RUN LED does not turn ON even though the computer is started.)
Occurrence frequency	
Occurrence condition	If the failure occurs only in the specific case, inform the occurrence condition noticed.
Troubleshooting result	Inform the following descriptions. The result of troubleshooting performed The situation when checking with other boards or computers. (Example: Event ID 295 "The Board WDT error had occurred." is displayed on the event viewer when the personal computer is started. It also occurs when mounting the problem board with another computer. Other boards mounted with the computer work properly.)

# 16.9 Error Code List

The list of error codes is shown.

For error codes not listed in this section, refer to the following:

MELSEC Data Link Library Reference Manual

MELSEC-Q CC-Link IE Field Network Master/Local Module User's Manual

If the error still occurs after the corrective action, please contact your local Mitsubishi Electric sales office or representative.

For information required for inquiries, refer to the following:

Page 176 Information Required for Inquiries

Error code	Error code	Corrective action
D000H to D00FH	Hardware error	Refer to corrective action for hardware error. ( Page 185 Hardware error)
D010H to D013H	Parameter error	Correct the points assigned to the link devices.
D014H to D016H	Hardware error	Refer to corrective action for hardware error. ( Page 185 Hardware error)
D018H	Parameter error	Correct the constant link scan time.
D019H to D020H	Hardware error	Refer to corrective action for hardware error. ( Page 185 Hardware error)
D030H to D035H	Connection failure	Correct the wiring condition.
D036H	Hardware error	Refer to corrective action for hardware error. ( Page 185 Hardware error)
D037H	Connection failure	Check the number of connected modules.
D040H	Hardware error	Refer to corrective action for hardware error. ( Page 185 Hardware error)
D041H	Connection failure	Check the number of connected modules.
D080H to D084H	Hardware error	Refer to corrective action for hardware error. ( Page 185 Hardware error)
D0A0H	Transient data transmission response wait timeout	If the own station or target station is disconnected from the network, identify the cause of the disconnection and take action. When the mode of the master station is "Online (High Speed Mode)", change it to "Online (Normal Mode)" and retry the operation. When the target station is overloaded and cannot receive transient data, reduce the frequency of transient transmission and retry the operation.
D0A1H	Transient data transmission completion wait timeout	Check if the cables and switching hub are connected properly. Exchange the cables between PORT1 and PORT2 and retry the operation. Reduce the frequency of transient transmission and then retry the operation. Perform hardware and self-loopback tests. ( Page 46 Hardware test, Page 47 Self-loopback test)
D0A2H	Transient data transmission processing wait timeout	Reduce the frequency of transient transmission and then retry the operation. Check if the cables and switching hub of the request source are connected properly.
D0A3H	Transient data transmission error	If the own station or target station is disconnected from the network, identify the cause of the disconnection and take action. Correct the target station number of the transient data, and retry the operation. If the target station of the transient data resides in another network, check if the routing parameters for respective stations are correctly set, and take corrective action.
D0A4H to D0A6H	Transient transmission failed	Check if the cables and switching hub are connected properly. Exchange the cables between PORT1 and PORT2 and retry the operation.
D0A7H	Transient reception failed	Reduce the frequency of transient transmission and then retry the operation. Perform hardware and self-loopback tests. ( Page 46 Hardware test, Page 47 Self-loopback test)
D0C0H to D0D0H	Process error	The error has occurred in the following process. Wait for a while, and retry the operation. <ul style="list-style-type: none"> <li>• D0C0H: Reserved station specification</li> <li>• D0C1H: Disabling the reserved station</li> <li>• D0C2H: Data link stop instruction</li> <li>• D0C3H: Data link start instruction</li> <li>• D0C4H: Temporary error invalid station setting</li> <li>• D0C5H: Cancellation of temporary error invalid station setting</li> <li>• D0C6H: Change of other station number setting</li> <li>• D0D0H: Other station number setting</li> </ul>
D0E0H	Station type mismatch	In "Network Configuration Setting" of the master station, change the station type to that of the own station.

Error code	Error code	Corrective action
D0E1H	Own station specified as reserved	In "Network Configuration Setting" of the master station, cancel the reserved station setting. Change the station number of the own station to a station number that is not reserved.
D0E2H	Station No. duplication (own station)	Change the station number so that it will not be duplicated with any other station number. After taking the above action, power OFF and then ON all the stations that detected the station number duplication error, or reset them.
D0E3H	Own station No. out of range	Add information of the own station to "Network Configuration Setting" of the master station.
D0E4H	Multiple master stations (including own station)	Check the network condition by CC-Link IE Field Network diagnostics, and take action. Check if the cables and switching hub are connected properly. After taking the above action, power OFF and then ON all the stations that detected this error, or reset them.
D0F0H to D113H	Hardware error	Refer to corrective action for hardware error. (☞ Page 185 Hardware error)
D200H	Transient data received twice	Check the network condition by CC-Link IE Field Network diagnostics, and take action. Check if the cables and switching hub are connected properly. If the request source resides in another network, check if the routing parameters are correctly set, and take corrective action.
D201H	Header information error in transient data	Correct the header information at the request source, and retry the operation.
D202H	Send buffer full	Reduce the frequency of transient transmission and then retry the operation. When the mode of the master station is "Online (High Speed Mode)", change it to "Online (Normal Mode)" and retry the operation. Check if the cables and switching hub are connected properly.
D203H	Read/write address error in transient data	Correct the read/write address at the request source, and retry the operation.
D204H	Network No. error in transient data	Correct the network number at the request source, and retry the operation. If the request source resides in another network, check if the routing parameters are correctly set, and take corrective action.
D205H	Target station No. error in transient data	Correct the target station number at the request source, and retry the operation.
D206H	Network No. error in transient data	Correct the network number at the request source, and retry the operation. If the request source resides in another network, check if the routing parameters are correctly set, and take corrective action.
D207H	Incorrect number of relays specified in transient data	Correct the system configuration to reduce the number of relay stations to seven or less. Check if the routing parameters are correctly set, and take corrective action.
D208H	Network No. error in transient data	Correct the network number at the request source, and retry the operation. If the request source resides in another network, check if the routing parameters are correctly set, and take corrective action.
D209H	Target station No. error in transient data	Correct the target station number at the request source, and retry the operation.
D20AH		
D20BH	Specified master station No. error in transient data	
D20CH	Current master station No. error in transient data	
D20DH	Transient data transmission completion wait timeout	Check the network condition by CC-Link IE Field Network diagnostics, and take action. When the own station or target station detected an error, identify the cause of the error and take action. Reduce the frequency of transient transmission and then retry the operation. When the mode of the master station is "Online (High Speed Mode)", change it to "Online (Normal Mode)" and retry the operation. Check if the cables and switching hub of the request source are connected properly.
D20EH	Header information error in transient data	Correct the header information at the request source, and retry the operation.
D20FH	Target station No. error in transient data	Check if the command can be requested to all or a group of stations at the request source, and retry the operation.
D210H	Target station No. error in transient data	Correct the header information at the request source, and retry the operation.
D211H	Own station No. undefined (dedicated instruction)	Set the station number in the parameter setting, and retry the operation.
D212H	Transient transmission failed	Check if the cables and switching hub of the request source are connected properly. Exchange the cables between PORT1 and PORT2 of the request source and retry the operation. Reduce the frequency of transient transmission and then retry the operation.
D213H	Transient data request error	Correct the request command at the request source, and retry the operation.

Error code	Error code	Corrective action
D214H	Transient data request error	Correct the data length at the request source, and retry the operation.
D215H	Transient data request error	Change the mode to Online, and retry the operation.
D216H to D217H	Transient data request error	Correct the request command at the request source, and retry the operation.
D218H	Transient data request error	At the request source, correct the number of the data to be read from or written to the device, and retry the operation.
D219H	Transient data request error	Correct the attribute code at the request source, and retry the operation.
D21AH	Transient data request error	Correct the access code at the request source, and retry the operation.
D21BH to D21CH	Transient data request error	Abnormal transient data were issued from the CPU module. Replace the CPU module and retry the operation. If this error persists, please contact your local Mitsubishi Electric sales office or representative.
D21DH	Network No. error in transient data	A cable test cannot be applied to a network of a different network number. Correct the data in "Testing Station Setting", and retry the cable test. Transient data that is not applicable to a different network were received. Correct the network number or target station number at the request source, and retry the operation.
D21EH	Target station No. error in transient data	The communication test cannot be executed with the relay station(s) specified. Correct "Communication Destination Setting", and then execute the communication test again. Transient data of the application type that is not executable for the own station were received. Correct the application type or target station number at the request source, and retry the operation.
D21FH	Target station type error (dedicated instruction)	The SEND instruction is not applicable to head modules. Modify the program so that the SEND instruction will not be used for head modules.
D220H	No master station	Add a master station to the network.
D222H	Transient data request error	Correct the request command at the request source, and retry the operation.
D223H	Transient error	Check the network condition by CC-Link IE Field Network diagnostics, and take action. Check if the cables and switching hub are connected properly. If the request source resides in another network, check if the routing parameters are correctly set, and take corrective action. If this error persists, please contact your local Mitsubishi Electric sales office or representative.
D22EH	Station No. setting not available for the target station	Although change of the target station number was attempted online from the master station, the target station does not have the online station number setting function. • Check the manual for the target station for availability of the station number setting function. • If the function is supported by the model, please contact your local Mitsubishi Electric sales office or representative.
D22FH	No baton pass for the target station	Check the communication status of the station whose station number will be changed.
D230H	Incorrect station No. specified	Station number change was attempted for the own station (master station). Check if no station number has been set for the target station of station number change.
D231H	Station No. already set for the target station	For the target station of station number change, a station number has already been set. Check if no station number has been set for the target station of station number change.
D232H	Station No. setting target not exist	The target station of station number change does not exist. Check if no station number has been set for the target station of station number change.
D234H	No baton pass	Check the communication status.
D235H	Transient error	Check the network condition by CC-Link IE Field Network diagnostics, and take action. Check if the cables and switching hub are connected properly. If the request source resides in another network, check if the routing parameters are correctly set, and take corrective action. If this error persists, please contact your local Mitsubishi Electric sales office or representative.
D240H to D243H	Target network module failure (dedicated instruction)	Correct the following settings at the request source of the dedicated instruction, and retry the operation. • D240H: Network number • D241H: Target station number • D242H: Command code • D243H: Channel used (correct within the range) If the request source resides in another network, check if the routing parameters are correctly set, and take corrective action.
D244H	Incorrect transient data	Correct the transient data at the request source, and retry the operation. If this error persists, please contact your local Mitsubishi Electric sales office or representative.
D245H	Target station No. error (dedicated instruction)	Correct the target station number at the request source of the dedicated instruction, and retry the operation. If the request source resides in another network, check if the routing parameters are correctly set, and take corrective action.
D246H	Incorrect transient data	Correct the transient data at the request source, and retry the operation. If this error persists, please contact your local Mitsubishi Electric sales office or representative.

Error code	Error code	Corrective action
D247H	Dedicated instruction received twice	Check the network condition by CC-Link IE Field Network diagnostics, and take action. Check if the cables and switching hub of the request source are connected properly. If the request source resides in another network, check if the routing parameters are correctly set, and take corrective action.
D248H	Incorrect transient data	Correct the transient data at the request source, and retry the operation. If this error persists, please contact your local Mitsubishi Electric sales office or representative.
D249H	Target station's CPU type error (dedicated instruction)	Correct the target station's CPU type at the request source of the dedicated instruction, and retry the operation. If the request source resides in another network, check if the routing parameters are correctly set, and take corrective action.
D24AH	Arrival monitoring time error (dedicated instruction)	Correct the arrival monitoring time at the request source of the dedicated instruction, and retry the operation. When the own station or target station has detected an error, identify the cause of the error and take action. Reduce the frequency of transient transmission and then retry the operation. When the mode of the master station is "Online (High Speed Mode)", change it to "Online (Normal Mode)" and retry the operation. Check if the cables and switching hub of the request source are connected properly.
D24BH	Number of resends error (dedicated instruction)	Correct the number of resends at the request source of the dedicated instruction, and retry the operation. When the own station or target station has detected an error, identify the cause of the error and take action. Reduce the frequency of transient transmission and then retry the operation. When the mode of the master station is "Online (High Speed Mode)", change it to "Online (Normal Mode)" and retry the operation. Check if the cables and switching hub of the request source are connected properly.
D24CH	Target network No. error (dedicated instruction)	Correct the network number at the request source of the dedicated instruction, and retry the operation. If the request source resides in another network, check if the routing parameters are correctly set, and take corrective action.
D24DH	Incorrect channel used for the dedicated instruction	For the SEND instruction, set 1 or 2 for the target channel No. in the control data. For the REMFR/REMTO instruction, set any of 1 to 32 for the channel No.
D24EH	Dedicated instruction error	An invalid value is set for the control block of the dedicated instruction. Correct the value, and then retry the operation. If this error persists, please contact your local Mitsubishi Electric sales office or representative.
D24FH	Own station No. undefined (dedicated instruction)	Set the station number in "Network Parameter", and retry the operation. If this error persists, please contact your local Mitsubishi Electric sales office or representative.
D250H	Flash ROM failure	The flash ROM may be faulty. Refer to corrective action for hardware error. (☞ Page 185 Hardware error)
D251H	Arrival confirmation error (dedicated instruction)	Correct the number of resends at the request source of the dedicated instruction, and retry the operation. When the own station or target station has detected an error, identify the cause of the error and take action. Reduce the frequency of transient transmission and then retry the operation. When the mode of the master station is "Online (High Speed Mode)", change it to "Online (Normal Mode)" and retry the operation. Check if the cables and switching hub of the request source are connected properly.
D252H	Transmission completion wait timeout (dedicated instruction)	Check the network condition by CC-Link IE Field Network diagnostics, and take action. Reduce the frequency of transient transmission and then retry the operation. When the mode of the master station is "Online (High Speed Mode)", change it to "Online (Normal Mode)" and retry the operation. If this error persists, please contact your local Mitsubishi Electric sales office or representative.
D253H	Response timer timeout (dedicated instruction)	The dedicated instruction did not end within the transient timeout monitoring time. Send data from other station may be received, or the specified target station for executing the dedicated instruction may be failed. • When executing the RECV instruction, check if a message is sent from another station. • Check the network condition by CC-Link IE Field Network diagnostics, and take action. • If this error persists, please contact your local Mitsubishi Electric sales office or representative.
D254H	Unsupported request received (dedicated instruction)	Change the target station at the station that sent the SEND instruction. If this error persists, please contact your local Mitsubishi Electric sales office or representative.
D255H	Target station No. error (dedicated instruction)	Check the target station number, and retry the operation. If this error persists, please contact your local Mitsubishi Electric sales office or representative.
D256H	Execution/abnormal end type error (dedicated instruction)	Check the execution/abnormal end type, and retry the operation. If this error persists, please contact your local Mitsubishi Electric sales office or representative.

Error code	Error code	Corrective action
D257H	Request type error (REQ)	Check the request type in the request data, and retry the operation. If this error persists, please contact your local Mitsubishi Electric sales office or representative.
D258H	Specified/current control station not exist (dedicated instruction)	Check the target station number, and retry the operation. If this error persists, please contact your local Mitsubishi Electric sales office or representative.
D259H	Mode error during dedicated instruction execution	Change the mode of the master station from "Loop test" to "Online", and execute it again. If this error persists, please contact your local Mitsubishi Electric sales office or representative.
D25AH	Channel in use (dedicated instruction)	Retry it after a little while. Change the channel for the own or target station.
D25BH	Channel in use (dedicated instruction)	Change the channel for the own or target station.
D25CH	Dedicated instruction error	An invalid value is set for the control block of the dedicated instruction. Correct the value, and then retry the operation. If this error persists, please contact your local Mitsubishi Electric sales office or representative.
D25DH	Incorrect transient data	Check the transient data at the request source, and retry the operation. If this error persists, please contact your local Mitsubishi Electric sales office or representative.
D25EH	Dedicated instruction error	Another CC-Link dedicated instruction is in execution. Retry it after a little while. If this error persists, please contact your local Mitsubishi Electric sales office or representative.
D25FH	Station type error (REMFR/REMTO executing station)	The REMFR/REMTO instruction is not available for stations other than master and local stations. Modify the program so that the REMFR/REMTO instruction will not be used.
D260H	Station type error (REMTO executing station)	The REMTO instruction is not available for local stations. The REMTO instruction must be executed on the master station.
D261H	Station type error (CCPASET executing station)	Parameter setting using the CCPASET instruction is not available for local stations. It must be executed to the master station.
D262H	Total linked stations setting error (CCPASET)	Correct the total number of linked stations in the control data, and retry the operation. If this error persists, please contact your local Mitsubishi Electric sales office or representative.
D263H	Constant link scan time setting error (CCPASET)	Correct the constant link scan time in the control data, and retry the operation. If this error persists, please contact your local Mitsubishi Electric sales office or representative.
D264H	Station No. range error (CCPASET)	Change the station number in the setting data to any of 1 to 120, and retry the operation. If this error persists, please contact your local Mitsubishi Electric sales office or representative.
D265H	Duplicate station No. (CCPASET)	Correct the station number in the setting data, and retry the operation. If this error persists, please contact your local Mitsubishi Electric sales office or representative.
D266H	Number of total device stations error (CCPASET)	Correct the number of total device stations in the setting data, and retry the operation. If this error persists, please contact your local Mitsubishi Electric sales office or representative.
D267H	Station type error (CCPASET)	Change the station type value in the setting data to any of 0 to 3, and retry the operation. If this error persists, please contact your local Mitsubishi Electric sales office or representative.
D268H	Device range assignment error (CCPASET)	Execute the function again after correcting the offset or size of the link device of the device station in the setting data. If this error persists, please contact your local Mitsubishi Electric sales office or representative.
D269H	Target station type error	Set the target station number in the REMFR/REMTO instruction to the station number of an intelligent device station.
D26AH	Target station No. error	Reconnect the target station of the REMFR/REMTO instruction.
D26BH	Network No. error (CCPASET executing station)	Set any of 1 to 239 to Switch 1 (network No.) in the intelligent function module switch setting of the master/local module.
D26CH	Station No. error (CCPASET executing station)	When activating as a master station, set 0 to Switch 2 in the intelligent function module switch setting of the master/local module. When activating as a local station by the CCPASET instruction, use a master/local module with a serial number whose first five digits are '12072' or higher. When activating as a local station, set a value within the range from 3101H to 3178H to Switch 2 in the intelligent function module switch setting of the master/local module.
D26DH	Mode error (CCPASET executing station)	Set 0 to Switch 3 in the intelligent function module switch setting of the master/local module
D280H	Transient data request error	Correct the request command at the request source, and retry the operation.
D281H	Transient reception failed	Check the network condition by CC-Link IE Field Network diagnostics, and take action. When the target station is overloaded and cannot receive transient data, send the data to the target station after the load on the station is reduced.
D282H	Receive queue full	Temporarily stop the transient transmission, and then retry the operation. Reduce the frequency of transient transmission and then retry the operation. Use the COM instruction to increase the frequency of transient transmission. If this error persists, please contact your local Mitsubishi Electric sales office or representative.

Error code	Error code	Corrective action
D283H	Transient transmission failed	Check the network condition by CC-Link IE Field Network diagnostics, and take action. Exchange the cables between PORT1 and PORT2 of the request source and retry the operation. Reduce the frequency of transient transmission and then retry the operation.
D2A0H	Receive buffer full	Check the network condition by CC-Link IE Field Network diagnostics, and take action. When the target station is overloaded and cannot receive transient data, send the data to the target station after the load on the station is reduced.
D2A1H	Send buffer full	Reduce the frequency of transient transmission and then retry the operation. Check if the cables and switching hub of the request source are connected properly.
D2A2H	Transmission completion wait timer timeout	Reduce the frequency of transient transmission and then retry the operation. When the mode of the master station is "Online (High Speed Mode)", change it to "Online (Normal Mode)" and retry the operation. Check if the cables and switching hub of the request source are connected properly.
D2A3H to D2ADH	Error in transient data	Adjust the following settings at the request source of transient, and retry the operation. <ul style="list-style-type: none"> <li>• D2A3H: Number of data (frame length)</li> <li>• D2A4H: Header information</li> <li>• D2A5H: Target station number</li> <li>• D2A6H: Request source number</li> <li>• D2A7H to D2A8H: Header information</li> <li>• D2A9H: Target network number</li> <li>• D2AAH: Target station number</li> <li>• D2ABH: Network number of the request source</li> <li>• D2ACH: Station number of the request source</li> <li>• D2ADH: Number of data (frame length)</li> </ul>
D2AEH	Target station No. error in transient data	The own station received transient data that is addressed to another station on the route. Check and correct the network and target station numbers, and retry the operation. Check if the routing parameters are correctly set, and take corrective action.
D2AFH	Target station No. error in transient data	Transient data transmission addressed to the own station was requested. Check the network number and target station number, and retry the operation. Check if the routing parameters are correctly set, and take corrective action.
D2B0H	Transient transmission failed	Check if the cables and switching hub of the request source are connected properly. Exchange the cables between PORT1 and PORT2 of the request source and retry the operation. Reduce the frequency of transient transmission and then retry the operation.
D602H to D609H	Parameter error	Write the network parameters to the board again. If this error persists, please contact your local Mitsubishi Electric sales office or representative.
D60AH	Parameter error (Link scan mode/constant link scan time setting error)	Set the link scan mode to asynchronous, or cancel the constant link scan time setting.
D60DH to D610H	Hardware error	Refer to corrective action for hardware error. (Page 185 Hardware error)
D611H to D618H	Parameter error (Device range assignment error)	Correct the link device size of device station(s), and retry the operation. <ul style="list-style-type: none"> <li>• D611H, D612H: RWw</li> <li>• D613H, D614H: RWr</li> <li>• D615H, D616H: RY</li> <li>• D617H, D618H: RX</li> </ul>
D619H to D61AH	Parameter error	Write the network parameters to the board again. If this error persists, please contact your local Mitsubishi Electric sales office or representative.
D61BH to D61EH	Parameter error (Overlapping of the device)	Correct the link device offset or size of device station(s), and retry the operation. <ul style="list-style-type: none"> <li>• D61BH: RWw</li> <li>• D61CH: RWr</li> <li>• D61DH: RY</li> <li>• D61EH: RX</li> </ul>
D61FH	CCPASET execution error	Erase the network parameter settings, select "Write to PLC", and execute the CCPASET instruction again.
D620H	Incorrect transient data	Check the transient data at the request source, and retry the operation. If this error persists, please contact your local Mitsubishi Electric sales office or representative.
D621H to D62CH	Parameter error	Write the network parameters to the board again. Correct the network parameters, and retry the operation. <ul style="list-style-type: none"> <li>• D622H: Number of total linked stations error</li> <li>• D624H: Constant link scan time setting error</li> <li>• D625H: Block data assurance per station setting error</li> <li>• D628H: Station type error</li> <li>• D629H: Station No. range error</li> </ul>

Error code	Error code	Corrective action
D62DH	Failed to start data link	The system failed to start data link due to any of the following causes. Remove the cause of the problem, and retry the operation. <ul style="list-style-type: none"> <li>• No station number setting</li> <li>• Own station error</li> <li>• Master station duplication</li> <li>• Station type mismatch</li> <li>• No master station</li> <li>• Invalid station number of the own station</li> <li>• Duplication of the own station number</li> <li>• Own station specified as reserved station</li> <li>• Parameter error</li> <li>• Parameters being sent</li> <li>• Parameters not received (Only the master station, and no device stations exist.)</li> <li>• Link stop instruction</li> </ul>
D630H	CCPASET execution error at local station	Specify the network number, station type, and station number in the switch setting, and execute the instruction again in the condition in which the network parameters are not set.
D701H	No station specified for Reserved station function disable/temporary error invalid station setting	Specify relevant station(s) in Reserved station function disable/temporary error invalid station setting (SW0010 to SW0017), and retry the operation.
D706H	Request error of temporary error invalid station setting/cancel or reserved station function disable/enable (when the own station is a local station)	For a local station, temporary error invalid station setting/cancel and reserved station function disable/enable cannot be executed. Retry it on the master station.
D70BH	Request error of temporary error invalid station setting/cancel or reserved station function disable/enable (when concurrently requested to multiple stations)	Temporary error invalid station setting/cancel by SB0010 and SB0011 and reserved station function disable/enable by SB0012 and SB0013 cannot be executed at the same time. Turn OFF all bits in SB0010 to SB0013, and turn ON only one bit of them in the relay.
D720H	Data link start/stop instruction out of range	Check the setting, and then stop or start data link.
D721H	Link start/stop retry error (to another station)	Retry the operation after stop or restart of cyclic transmission is completed.
D722H	Link start/stop retry error (to own station)	
D723H	Link start/stop retry error (to entire system)	
D724H	Link start/stop station error	Check the setting, and then stop or start cyclic transmissions.
D725H	Station type error (station executing data link start/stop to the entire system)	A local station cannot start or stop data link of all or multiple stations. Execute data link start/stop of all or multiple stations from the master station
D726H	Transient data request error	Correct the request command at the request source, and retry the operation.
D727H	Data link start/stop instructing station error	Link start was instructed from a station different from the station that instructed the link stop. The station instructing a link start must be the same as the station that instructed the link stop. The method of the link start (data link start instruction in CC-Link IE Field Network diagnostics or by using the link special relay (SB) or link special register (SW) in the program) is different from that of the link stop. Instruct the link start by the same method as used for the link stop instruction. Link start has failed in the past. Force the system to restart data link.
D728H	Data link start/stop instructing station error	Link start was instructed during execution of data link. Instruct link start after instruction of link stop.
D780H	History acquisition setting data full	The area for writing history acquisition setting data for the network event history is insufficient. Reset or power OFF and then ON the module.
D781H	Hardware error	Refer to corrective action for hardware error. (☞ Page 185 Hardware error)
D782H	History acquisition setting data error	The previous history acquisition setting data for the network event history was not written successfully. Reset or power OFF and then ON the module.
D783H to D784H	Transient data request error	The read request in "CC-Link IE Field Network Diagnostics" is incorrect. Close the CC-Link IE Field Network diagnostics dialog box, and request it again. Check the read request data at the request source station, and retry the operation.
D785H	Flash ROM failure	The maximum number of writes to the flash ROM is exceeded. Replace the master/local module or board.

Error code	Error code	Corrective action
D786H	Flash ROM failure	The flash ROM may be faulty. Perform hardware and self-loopback tests. (☞ Page 46 Hardware test, Page 47 Self-loopback test)
D800H to D805H	Hardware error	Refer to corrective action for hardware error. (☞ Page 185 Hardware error)
D806H	Receive queue full	Reduce the frequency of transient transmission and then retry the operation. Check if the cables and switching hub are connected properly. Use the COM instruction to increase the frequency of transient transmission.
D807H	Hardware error	Refer to corrective action for hardware error. (☞ Page 185 Hardware error)
D80AH to D80FH	Parameter error	Write the network parameters again to the programmable controller. If this error persists, please contact your local Mitsubishi Electric sales office or representative.
D812H to D813H	Parameter check result error	
D814H to D819H	Hardware error	Refer to corrective action for hardware error. (☞ Page 185 Hardware error)
D81AH	CPU module stop error (Board driver stop error)	Check the error in the "PLC Diagnostics" screen in GX Works2, and take action. If the error has occurred on the board, check it in the event viewer. (☞ Page 169 Checking operations with event viewer)
D81BH	Programmable controller power failure	The power is OFF. Turn it ON.
D81DH to D825H	Buffer memory start parameter error	Correct the following settings in the buffer memory start parameter area <ul style="list-style-type: none"> <li>• D81DH: Total linked stations range</li> <li>• D81FH: Station number range</li> <li>• D820H: Total linked stations range</li> <li>• D821H: Device station setting information</li> <li>• D822H: Station type</li> <li>• D823H: Offset values or points assigned to the devices of each station</li> <li>• D824H: Setting flag</li> <li>• D825H: Setting flag, application parameter, and information setting data</li> </ul>
D826H	Flash ROM failure	The maximum number of writes to the flash ROM is exceeded. Check the network event history and configure the setting such as not to generate events consecutively. This error code cannot be cleared. To clear this error code, please contact your local Mitsubishi Electric sales office or representative.
D827H	Communication RAM failure	Refer to corrective action for hardware error. (☞ Page 185 Hardware error)
D902H	Incorrect online test data	Check the data at the station that initiated the online test, and retry the test. If this error persists, please contact your local Mitsubishi Electric sales office or representative.
D903H	Communication test retry error	After completion of the communication test, retry it.
D905H	Communication monitoring time in communication test timed out	Check the network condition by CC-Link IE Field Network diagnostics, take action, and retry the operation. Check if the routing parameters are correctly set.
D906H	Communication test transmission completion wait timeout	Check the network condition by CC-Link IE Field Network diagnostics, take action, and retry the operation. Reduce the frequency of transient transmission and then retry the operation. When the mode of the master station is "Online (High Speed Mode)", change it to "Online (Normal Mode)" and retry the operation. Check if the routing parameters are correctly set.
D909H	Header information error in transient data	Correct the header information at the request source, and retry the operation.
D90AH	Communication test data received twice	Check the network condition by CC-Link IE Field Network diagnostics, take action, and retry the operation.
D90BH	Incorrect number of stations	Check the network condition by CC-Link IE Field Network diagnostics, and take action. If the number of device stations per network is more than 120, reduce it to 120 or less.
D90CH	Communication target station specification error	Check "Communication Destination Setting" of the communication test, and retry the operation.
D90DH	Cable test retry error	After completion of the cable test, retry it.
DA00H to DAE7H	Hardware error	Refer to corrective action for hardware error. (☞ Page 185 Hardware error)
DAE8H	Switch setting error	When using the CCPASET instruction, check the intelligent function module switch settings, and write the setting data to the CPU module. When not using the CCPASET instruction, clear the intelligent function module switch settings, and rewrite the setting data to the CPU module. If this error persists, please contact your local Mitsubishi Electric sales office or representative.
DAF1H	Hardware error	Refer to corrective action for hardware error. (☞ Page 185 Hardware error)

Error code	Error code	Corrective action
DAF2H	Failed to write to flash ROM	The flash ROM may be faulty.
DAF3H	MAC address read error	Refer to corrective action for hardware error. (☞ Page 185 Hardware error)
DAF5H to DAF7H	Hardware error	Refer to corrective action for hardware error. (☞ Page 185 Hardware error)
DAF8H to DAF9H	Flash ROM failure	The flash ROM may be faulty. Refer to corrective action for hardware error. (☞ Page 185 Hardware error)

## Hardware error

- A malfunction may have occurred due to noise. Check the wire and cable lengths and grounding condition of each device, and take measures against noise. (☞ Page 38 PROCEDURE BEFORE OPERATION)
- Hardware may be faulty. Test the board alone. (☞ Page 171 Board test)

# APPENDIX

## Appendix 1 Precautions for Accessing Redundant CPU System

This section explains precautions for accessing a redundant CPU system via CC-Link IE Controller Network or MELSECNET/H network using the CC-Link IE Field Network board.

### Redundant CPU specification

When the system (control system, standby system, system A, system B) of the Redundant CPU is specified to access the Redundant CPU, the Logical station No. set in the "Target setting" screen of the CC IE Field Utility is used for access. For the Logical station No. setting, refer to the following:

☞ Page 115 Target setting

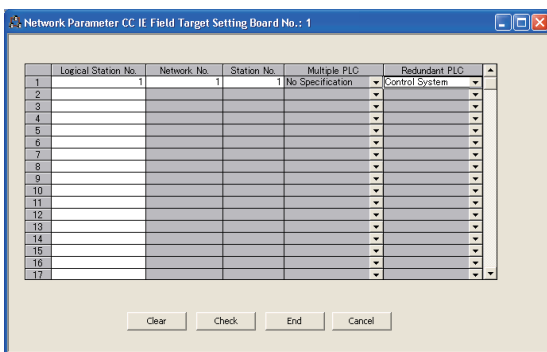

### Operation at occurrence of system switching

When system switching occurs during access to the Redundant CPU, access to the Redundant CPU set for the Logical station No. is continued.

**Ex.**

When the following Logical station No.(66) was specified for access

Item	Description
Logical station No.(66)	—
Network No.	1
Station No.	1
Multiple PLC	Not specified
Redundant PLC	Control system

<Before system switching>

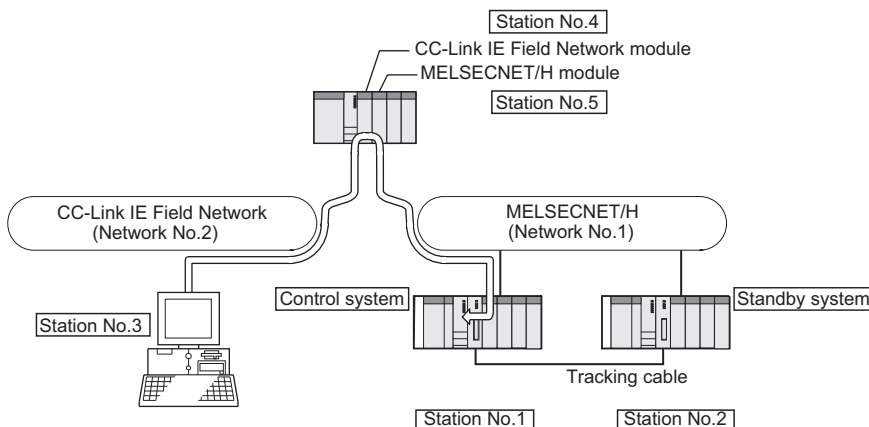

<After system switching>

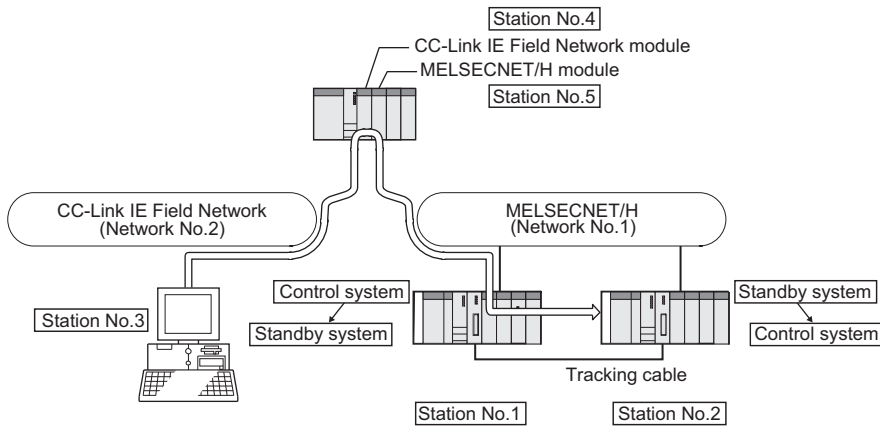

## Checking the system to access target

To check which system in the Redundant CPU system is being accessed by the CC-Link IE Field Network board, create a program to monitor the following special relays.

The flag status does not change even if the tracking cable is disconnected.

- When checking which system is being accessed, System A or System B

Special relay	System A	System B	At the time of TRK.CABLE ERR. (Error code: 6120) occurrence (System not determined)
SM1511 (System A identification flag)	ON	OFF	OFF
SM1512 (System B identification flag)	OFF	ON	OFF

- When checking the operation system status

Special relay	Control system	Standby system	At the time of TRK.CABLE ERR. (Error code: 6120) occurrence (System not determined)
SM1515 (Control system judgment flag)	ON	OFF	OFF
SM1516 (Standby system judgment flag)	OFF	ON	OFF

## Retry processing for the error that occurs during system switching processing

When the MELSEC data link library is used to access the Redundant CPU during system switching being processed by the Redundant CPU, a system switching error (error code: 4248H), CPU starting error (error code: 4004H), other system CPU module error (error code: 4245H), access destination illegal error (error code: FFDFH) or similar error occurs.

In this case, create a user program that checks the error code and performs retry processing as necessary.

## Functions that result in error if executed during system switching

Functions that result in error by system switching	
MELSEC data link library	mdDevSetEx, mdDevRstEx, mdRandREx, mdRandWEx, mdReceiveEx, mdSendEx, mdControl, mdDevRst, mdDevSet, mdRandR, mdRandW, mdReceive, mdSend, mdTypeRead

A

## Error occurrence

The following example gives a flowchart for error occurrence at batch write.

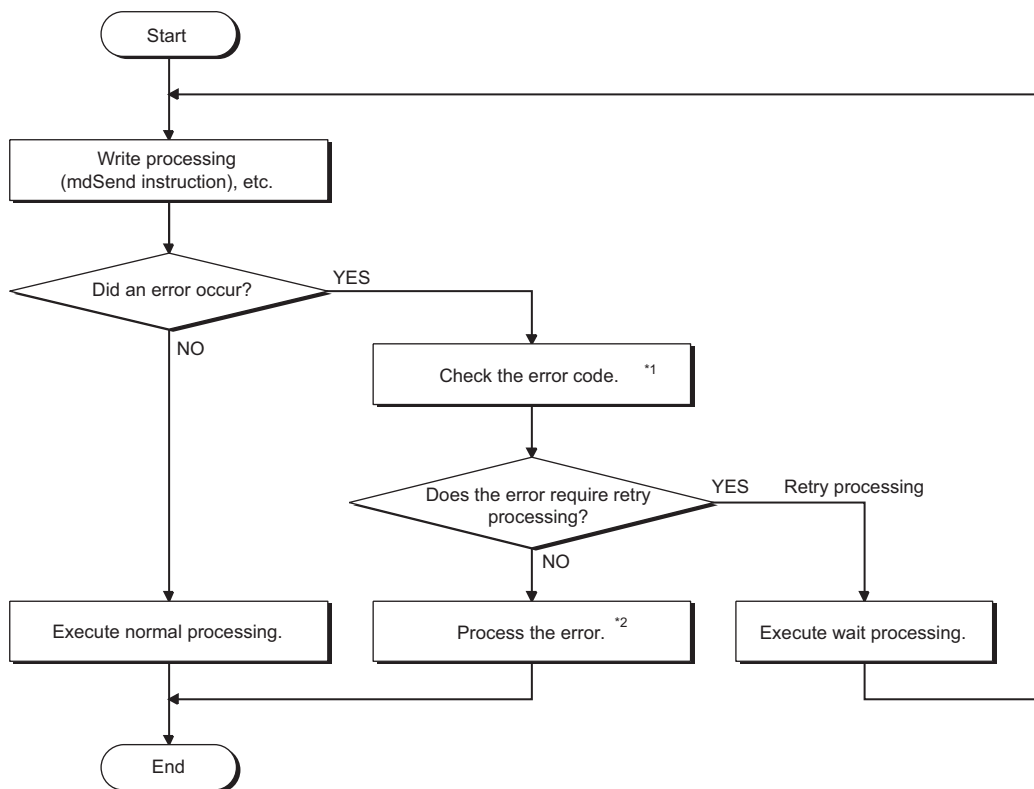

\*1 For details and corrective action of the error code, refer to the following:

📖 QCPU User's Manual (Hardware Design, Maintenance and Inspection)

\*2 Execute retry processing as required depending on the system specifications.

## Automatic switching of communication path

When a communication error occurs during access to the Redundant CPU connected via MELSECNET/H, the communication path is automatically switched to continue access to the control system.

Hereinafter, this automatic switching of the communication path is referred to as path switching.

The following describes the path switching conditions, checking method of path switching occurrence, and access examples of path switching.

### Path switching conditions

When access is being processed under the following conditions, access to the Redundant CPU is continued by path switching even though a communication error occurs.

Conditions for continued access	
Operation mode	Backup mode, Separate mode
Redundant CPU specification	Control system, Standby system, System A, System B

Note, however, that if a tracking error\*1 has already occurred at the start of communication, access to the control system is not continued by path switching even if tracking is recovered after that.

\*1 Includes the status in which either Redundant CPU is powered OFF or reset.

## Checking method of path switching occurrence

When the system is communicating with the redundant CPU specification, whether communication is continued by path switching due to communication error occurrence can be estimated.

Create a program that monitors the following special relay and special registers to check the occurrence of path switching.

<Special relay and special registers to be monitored and estimated possibility of path switching>

SM1600*1	SD1590*2	SD1690*2	Possibility of path switching	Reference
OFF	Either one is other than 0		Since a system switching request from the network module was detected, path switching may have been executed.	Page 189 Access examples of path switching Figure 1
ON	0	0	Since another system error occurred, path switching may have been executed.	Page 189 Access examples of path switching Figure 2
ON	Either one is other than 0		Since another system error occurred or a system switching request from the network module was detected, path switching may have been executed.	Page 189 Access examples of path switching Figure 1, Figure 2

\*1 Even if SM1600 is ON, path switching does not occur when the CPU is not accessed via the tracking cable.

\*2 When using SM1600, SD1590, and SD1690 to estimate the occurrence of path switching for the Redundant CPU connected via MELSECNET/H, check the following items on the Redundant settings in the network parameter of GX Developer.

Issue system switch in Cable disconnection timeout

Issue system switch in communication error

Check the following based on the statuses of the above special relay and special registers, and remove the error cause.

- Check the Redundant CPU for an error.
- Check the tracking cable status and whether the tracking cable is correctly connected.
- Check both the relevant network module and the network where that relevant network module is connected for an error.

## Access examples of path switching

The following shows examples of path switching during access to the control system.

<Figure 1 When system switching occurs due to communication error>

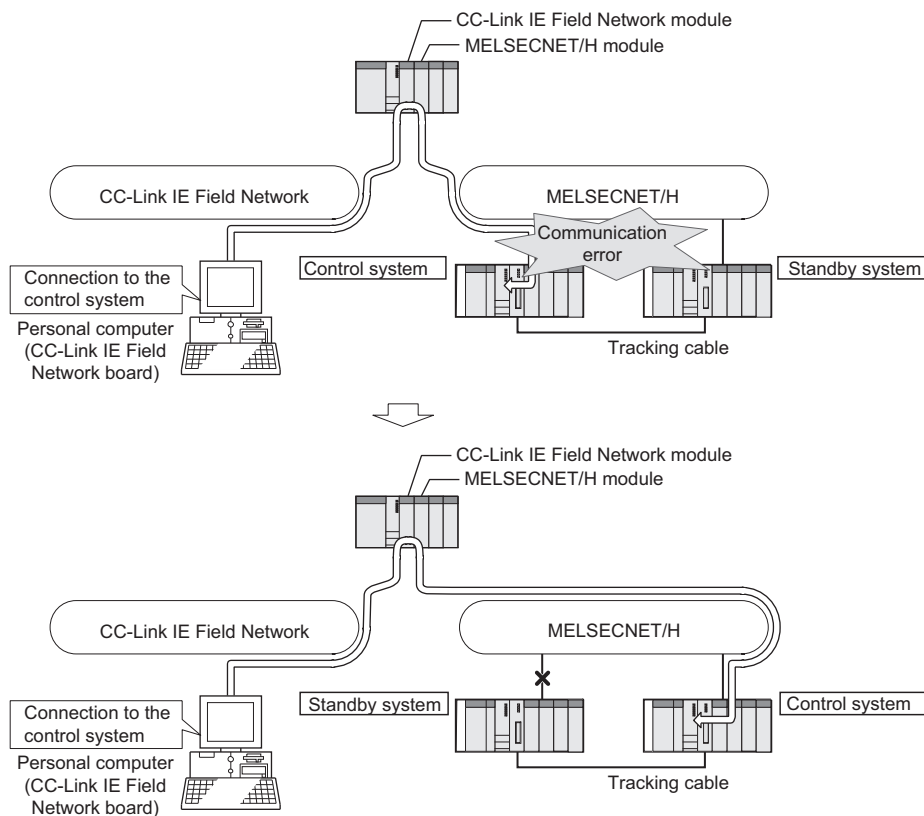

<Figure 2 When system switching occurs due to standby system error>

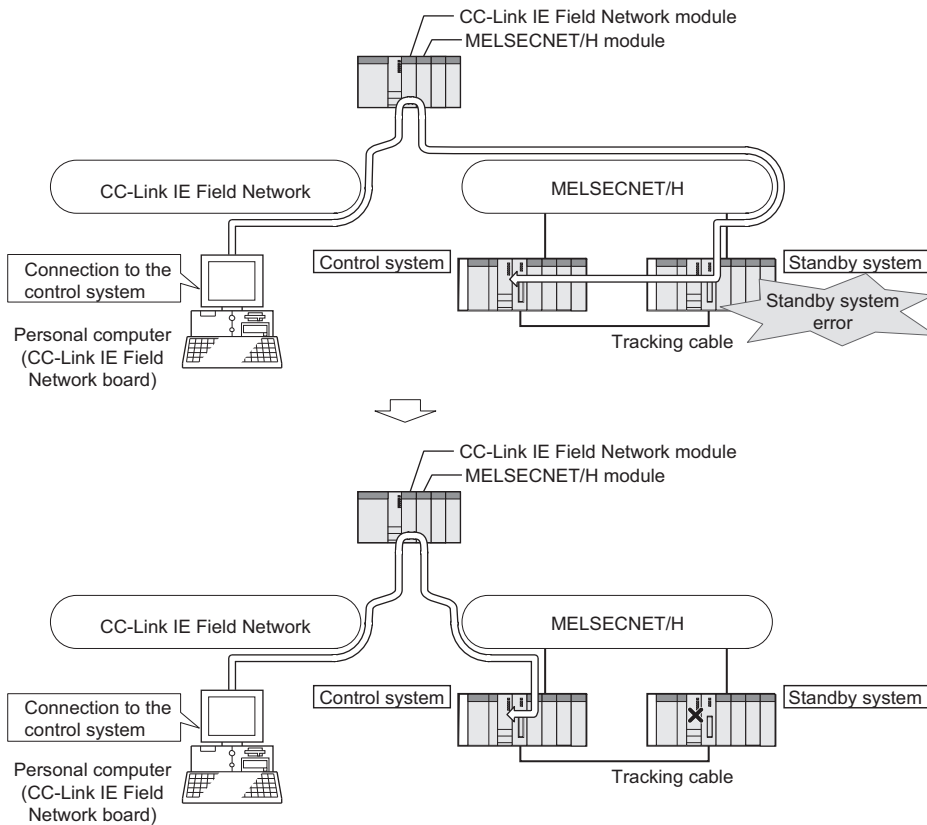

**Point**

- Path switching is not executed when a communication to the Redundant CPU specified at Logical station No. is faulty at communication start\*<sup>1</sup> (A communication error occurs.)  
When a communication is faulty, refer to the following and clear the communication disturbance.  
(☞ Page 189 Checking method of path switching occurrence, Page 189 Access examples of path switching)
- If other station access (including the programmable controller CPU other than the Redundant CPU) is made to 257 or more stations simultaneously, communication path may not be automatically switched.

\*<sup>1</sup> First communication after execution of the mdOpen function in the MELSEC data link library (communications using the mdReceiveEx, mdSendEx, mdDevRstEx, mdDevSetEx, mdRandREx, mdRandWEx, mdReceive, mdSend, mdControl, mdDevRst, mdDevSet, mdRandR, mdRandW or mdTypeRead function).

## ■Details of the special relay and special registers to be monitored when estimating the occurrence of path switching

No.	Name	Description	Description details
SM1600	Other system error flag	OFF: No error ON: Error	<ul style="list-style-type: none"> <li>Turns ON when an error occurs by redundant system error check. (Turns ON when any of bits for SD1600 turns ON.)</li> <li>Remains OFF when no errors are present.</li> </ul>
SD1590	No. of module for which system switching request is issued from the network module in own system	No. of module for which system switching request is issued from the network module in own system	<ul style="list-style-type: none"> <li>Any of the following bits turns ON corresponding to the No. of the module for which system switching request is issued from the network module in own system.</li> <li>Turned OFF by the system after the error of the relevant module is resolved by the user.</li> </ul> <div style="text-align: center;"> <p style="text-align: right;">Each bit 0 : OFF 1 : ON</p> </div> <ul style="list-style-type: none"> <li>For No. of module for which system switching request is issued from the network module in another system, refer to SD1690.</li> </ul>
SD1690	No. of module for which system switching request is issued from the network module in another system	No. of module for which system switching request is issued from the network module in another system	<ul style="list-style-type: none"> <li>Any of the following bits turns ON corresponding to the No. of the module for which system switching request is issued from the network module in another system.</li> <li>Turned OFF by the system after the error of the relevant module is resolved by the user.</li> </ul> <div style="text-align: center;"> <p style="text-align: right;">Each bit 0 : OFF 1 : ON</p> </div> <ul style="list-style-type: none"> <li>For No. of module for which system switching request is issued from the network module in own system, refer to SD1590.</li> </ul>

# Appendix 2 Details of Buffer Memory Addresses

Describes the buffer memory of the CC-Link IE Field Network board.

Address (Decimal) (Hexadecimal)	Name	Reference
0 to 18975 (0000H to 4A1FH)	Link device area	Page 192 Link device area
19456 to 20463 (4C00H to 4FEFH)	Offset/size information	Page 194 Offset/size information
20512 to 20536 (5020H to 5038H)	Own station information	Page 196 Own station information
20544 to 24383 (5040H to 5F3FH)	Other station information	Page 197 Other station information

## Link device area

The areas to store the values of link devices.

Address (Decimal) (Hexadecimal)	Name	Reference
0 to 1023 (0000H to 03FFH)	Remote input (RX)	Page 192 Remote input (RX) (Address 0 to 1023 (0000H to 03FFH))
1024 to 2047 (0400H to 07FFH)	Remote output (RY)	Page 192 Remote output (RY) (Address 1024 to 2047 (0400H to 07FFH))
2048 to 10239 (0800H to 27FFH)	Remote register (RWw)	Page 193 Remote register (RWw) (Address 2048 to 10239 (0800H to 27FFH))
10240 to 18431 (2800H to 47FFH)	Remote register (RWr)	Page 193 Remote register (RWr) (Address 10240 to 18431 (2800H to 47FFH))
18432 to 18463 (4800H to 481FH)	Link special relay (SB)	Page 193 Link special relay (SB) (Address 18432 to 18463 (4800H to 481FH))
18464 to 18975 (4820H to 4A1FH)	Link special register (SW)	Page 193 Link special register (SW) (Address 18464 to 18975 (4820H to 4A1FH))

## Remote input (RX) (Address 0 to 1023 (0000H to 03FFH))

The areas to store the value of RX. The RX start number and number of points for each station number can be checked by the RX offset/size information.

☞ Page 194 RX offset/size information (Address 19456 to 19695 (4C00H to 4CEF))

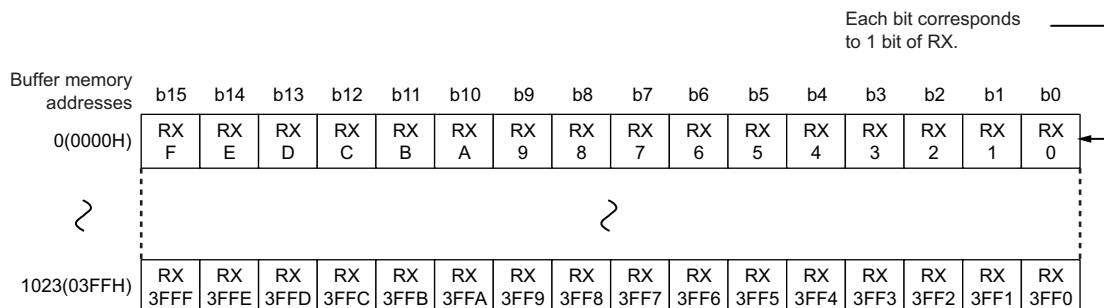

## Remote output (RY) (Address 1024 to 2047 (0400H to 07FFH))

The areas to store the value of RY. The RY start number and number of points for each station number can be checked by the RY offset/size information.

☞ Page 194 RY offset/size information (Address 19712 to 19951 (4D00H to 4DEF))

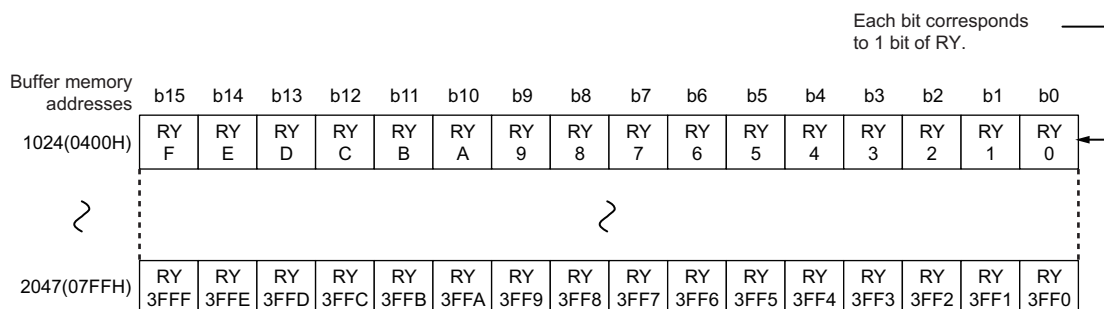

## Remote register (RWw) (Address 2048 to 10239 (0800H to 27FFH))

The areas to store the value of RWw. The RWw start number and number of points for each station number can be checked by the RWw offset/size information.

☞ Page 195 RWw offset/size information (Address 19968 to 20207 (4E00H to 4EEFH))



## Remote register (RWr) (Address 10240 to 18431 (2800H to 47FFH))

The areas to store the value of RWr. The RWr start number and number of points for each station number can be checked by the RWr offset/size information.

☞ Page 195 RWr offset/size information (Address 20224 to 20463 (4F00H to 4FEFH))



## Link special relay (SB) (Address 18432 to 18463 (4800H to 481FH))

The areas to store the value of SB.

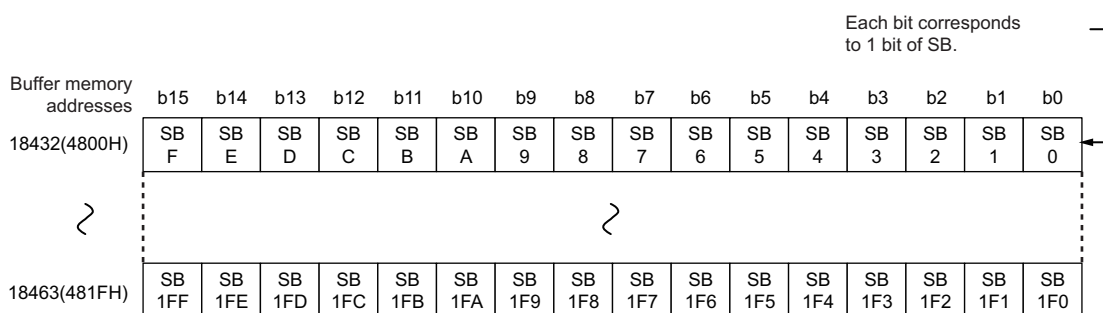

## Link special register (SW) (Address 18464 to 18975 (4820H to 4A1FH))

The areas to store the value of SW.



A

## Offset/size information

The areas to store the device start number and number of points for each station number.

Address (Decimal (Hexadecimal))	Name	Reference
19456 to 19695 (4C00H to 4CEF H)	RX offset/size information	Page 194 RX offset/size information (Address 19456 to 19695 (4C00H to 4CEF H))
19712 to 19951 (4D00H to 4DEF H)	RY offset/size information	Page 194 RY offset/size information (Address 19712 to 19951 (4D00H to 4DEF H))
19968 to 20207 (4E00H to 4EEF H)	RWw offset/size information	Page 195 RWw offset/size information (Address 19968 to 20207 (4E00H to 4EEF H))
20224 to 20463 (4F00H to 4FEF H)	RWr offset/size information	Page 195 RWr offset/size information (Address 20224 to 20463 (4F00H to 4FEF H))

### RX offset/size information (Address 19456 to 19695 (4C00H to 4CEF H))

The areas to store the RX start number and number of points for each station No.

Buffer memory  
addresses

19456(4C00H)	Station No.1	Offset
19457(4C01H)	Station No.1	Size (in units of words)
19458(4C02H)	Station No.2	Offset
19459(4C03H)	Station No.2	Size (in units of words)
⋮		
19694(4CEEH)	Station No.120	Offset
19695(4CEF H)	Station No.120	Size (in units of words)

The offset and size of buffer memory address for each station number (other than a station number 0) can be calculated using the following formulas:

- Offset buffer memory address =  $19456 + (\text{station number} - 1) \times 2$
- Size buffer memory address =  $19457 + (\text{station number} - 1) \times 2$

### RY offset/size information (Address 19712 to 19951 (4D00H to 4DEF H))

The areas to store the RY start number and number of points for each station No.

Buffer memory  
addresses

19712(4D00H)	Station No.1	Offset
19713(4D01H)	Station No.1	Size (in units of words)
19714(4D02H)	Station No.2	Offset
19715(4D03H)	Station No.2	Size (in units of words)
⋮		
19950(4DEEH)	Station No.120	Offset
19951(4DEF H)	Station No.120	Size (in units of words)

The offset and size of buffer memory address for each station number (other than a station number 0) can be calculated using the following formulas:

- Offset buffer memory address =  $19712 + (\text{station number} - 1) \times 2$
- Size buffer memory address =  $19713 + (\text{station number} - 1) \times 2$

## RWw offset/size information (Address 19968 to 20207 (4E00H to 4EEFH))

The areas to store the RWw start number and number of points for each station number.

Buffer memory addresses		
19968(4E00H)	Station No.1	Offset
19969(4E01H)	Station No.1	Size (in units of words)
19970(4E02H)	Station No.2	Offset
19971(4E03H)	Station No.2	Size (in units of words)
20206(4EEEH)	Station No.120	Offset
20207(4EEFH)	Station No.120	Size (in units of words)

The offset and size of buffer memory address for each station number (other than a station number 0) can be calculated using the following formulas:

- Offset buffer memory address =  $19968 + (\text{station number} - 1) \times 2$
- Size buffer memory address =  $19969 + (\text{station number} - 1) \times 2$

## RWr offset/size information (Address 20224 to 20463 (4F00H to 4FEFH))

The areas to store the RWr start number and number of points for each station number.

Buffer memory addresses		
20224(4F00H)	Station No.1	Offset
20225(4F01H)	Station No.1	Size (in units of words)
20226(4F02H)	Station No.2	Offset
20227(4F03H)	Station No.2	Size (in units of words)
20462(4FEEH)	Station No.120	Offset
20463(4FEFH)	Station No.120	Size (in units of words)

The offset and size of buffer memory address for each station number (other than a station number 0) can be calculated using the following formulas:

- Offset buffer memory address =  $20224 + (\text{station number} - 1) \times 2$
- Size buffer memory address =  $20225 + (\text{station number} - 1) \times 2$

## Own station information

The areas to store the own station's information on the network.

### Network card information (Address 20512 to 20515 (5020H to 5023H))

Address (Decimal (Hexadecimal))	Name	Description
20512 (5020H)	Manufacturer code	The own station's board information is stored.
20513 (5021H)	Model type	
20514 (5022H)	Model code	
20515 (5023H)	Version	

### Controller information (Address 20520 to 20536 (5028H to 5038H))

Address (Decimal (Hexadecimal))	Name	Description
20520 (5028H)	Controller information valid/invalid flag	Whether the value stored in the own station (controller) information is valid or invalid is stored. 0: Invalid 1: Valid
20521 (5029H)	Manufacturer code	The own station's board information is stored.
20522 (502AH)	Model type	
20523 (502BH)	Model code	
20524 (502CH)	Version	
20525 to 20534 (502DH to 5036H)	Model name string	
20535 to 20536 (5037H to 5038H)	Vendor-specific device information	

## Other station information

The areas to store the other stations information on the network.

### Station number 1 (Address 20544 to 20575 (5040H to 505FH))

#### ■ Network card information (Address 20544 to 20551 (5040H to 5047H))

Address (Decimal (Hexadecimal))	Name	Description
20544 (5040H)	Manufacturer code	The information of other station (station No.1) is stored.
20545 (5041H)	Model type	
20546 (5042H)	Model code	
20547 (5043H)	Version	
20548 to 20551 (5044H to 5047H)	System area	—

#### ■ Controller information (Address 20552 to 20575 (5048H to 505FH))

Address (Decimal (Hexadecimal))	Name	Description
20552 (5048H)	Controller information valid/invalid flag	Whether the value stored in the other station (controller) information (station number 1) is valid or invalid is stored. 0: Invalid 1: Valid
20553 (5049H)	Manufacturer code	The other station's information is stored.
20554 (504AH)	Model type	
20555 (504BH)	Model code	
20556 (504CH)	Version	
20557 to 20566 (504DH to 5056H)	Model name string	
20567 to 20568 (5057H to 5058H)	Vendor-specific device information	
20569 to 20575 (5059H to 505FH)	System area	—

### Station number 2 to 120 (Address 20576 to 24383 (5060H to 5F3FH))

The information for station number 2 to 120 is stored in the same order as the information for other station (network card) information (station number 1) and other station (controller) information (station number 1).

A

# Appendix 3 Link Special Relay (SB) List

A link special relay (SB) is turned ON/OFF depending on various factors at data link. Any error status of the data link can be confirmed by using and monitoring it in the program.

## Application of the link special relay (SB)

By using link special relays (SB), the status of the CC-Link IE Field Network can be checked.

## Ranges of areas that are turned ON/OFF by users and by the system

The following is a range when the link special relays (SB) are assigned from SB0000 to SB01FF.

Range turned ON/OFF by users: SB0000 to SB001F

Range turned ON/OFF by the system: SB0020 to SB01FF

## Link special relay (SB) list

A list of link special relays (SB) when they are assigned from SB0000 to SB01FF is as follows.



Do not turn ON or OFF areas whose numbers are not on the link special relay (SB) list. Doing so may cause malfunction of the programmable controller system.

Number	Name	Description	Availability	
			Master station	Local station
SB0000	Link start (own station)	The own station's cyclic transmission is restarted. <ul style="list-style-type: none"> <li>• OFF: No start direction</li> <li>• ON: Start direction (enabled during start-up)</li> </ul> (Conditions) <ul style="list-style-type: none"> <li>• This is enabled when the Baton pass status (own station) (SB0047) is OFF.</li> <li>• For SB0000 to SB0003, this is enabled when only one of them is turned ON.</li> </ul>	○	○
SB0001	Link stop (own station)	The own station's cyclic transmission is stopped. <ul style="list-style-type: none"> <li>• OFF: No stop direction</li> <li>• ON: Stop direction (enabled during start-up)</li> </ul> (Conditions) <ul style="list-style-type: none"> <li>• This is enabled when the Baton pass status (own station) (SB0047) is OFF.</li> <li>• For SB0000 to SB0003, this is enabled when only one of them is turned ON.</li> </ul>	○	○
SB0002	System link start	Cyclic transmission of the entire system is restarted. The station where cyclic transmission is restarted is specified by the Link stop/start direction (SW0000 to SW0008). <ul style="list-style-type: none"> <li>• OFF: No start direction</li> <li>• ON: Start direction (enabled during start-up)</li> </ul> (Conditions) <ul style="list-style-type: none"> <li>• This is enabled when the Baton pass status (own station) (SB0047) is OFF.</li> <li>• For SB0000 to SB0003, this is enabled when only one of them is turned ON.</li> </ul>	○	×
SB0003	System link stop	Cyclic transmission of the entire system is stopped. The station where cyclic transmission is stopped is specified by the Link stop/start direction (SW0000 to SW0008). <ul style="list-style-type: none"> <li>• OFF: No stop direction</li> <li>• ON: Stop direction (enabled during start-up)</li> </ul> (Conditions) <ul style="list-style-type: none"> <li>• This is enabled when the Baton pass status (own station) (SB0047) is OFF.</li> <li>• For SB0000 to SB0003, this is enabled when only one of them is turned ON.</li> </ul>	○	×
SB0006	Clear communication error count	Clears the link special registers for the communication error (SW0068 to SW006B, SW0074 to SW0077, SW007C to SW007F, SW0120 to SW015F). <ul style="list-style-type: none"> <li>• OFF: No clear direction</li> <li>• ON: Clear direction</li> </ul>	○	○
SB0009	Event count clear	This clears the Event history status (SB007A) and Event count (SW007A). <ul style="list-style-type: none"> <li>• OFF: No clear direction</li> <li>• ON: Clear direction (Errors are not counted while this is ON.)</li> </ul>	○	○
SB0010	Temporary error invalid request	Stations specified in Reserved station function disable/temporary error invalid station setting (SW0010 to SW0017) are set as temporary error invalid stations. <ul style="list-style-type: none"> <li>• OFF: No request</li> <li>• ON: Request issued</li> </ul>	○	×

Number	Name	Description	Availability	
			Master station	Local station
SB0011	Temporary error invalid setting cancel request	Stations specified in Reserved station function disable/temporary error invalid station setting (SW0010 to SW0017) are canceled from temporary error invalid stations. • OFF: No request • ON: Request issued	○	×
SB0012	Reserved station function disable request	Stations specified in Reserved station function disable/temporary error invalid station setting (SW0010 to SW0017) are temporarily canceled from reserved stations. • OFF: No request • ON: Request issued	○	×
SB0013	Reserved station specification enable request	Stations specified in Reserved station function disable/temporary error invalid station setting (SW0010 to SW0017) are returned to reserved stations. Only stations that were temporarily canceled can be returned to reserved stations. • OFF: No request • ON: Request issued	○	×
SB0030	RECV execution request flag (1)	This stores the data reception status of the own station's channel 1. • OFF: No received data • ON: Received data found (Conditions) This is enabled when the Baton pass status (own station) (SB0047) is OFF.	○	○
SB0031	RECV execution request flag (2)	This stores the data reception status of the own station's channel 2. • OFF: No received data • ON: Received data found (Conditions) This is enabled when the Baton pass status (own station) (SB0047) is OFF.	○	○
SB0040	Network type (own station)	Stores the network type of own station. • ON: Field Network	○	○
SB0043	Mode (own station)	Stores the mode of own station. • OFF: Online • ON: Not online	○	○
SB0044	Station setting (own station) (1)	This stores if the own station is a master station or not. • OFF: Not master station • ON: Master station	○	○
SB0045	Station setting (own station) (2)	This stores if the own station is a local station or not. • OFF: Not local station • ON: Local station (Conditions) This is enabled when the Station setting (own station) (1) (SB0044) is OFF.	×	○
SB0047	Baton pass status (own station)	Stores the baton pass status for the own station (transient transmission possible). • OFF: Normal • ON: Error If an error occurs, the cause of the error can be checked by the Baton pass status (own station) (SW0047) and Cause of baton pass interruption (SW0048). Depending on the timing of the link refresh, the update of Baton pass status (own station) (SW0047) and Cause of baton pass interruption (SW0048) may be offset by one sequence scan.	○	○
SB0049	Data link status (own station)	Stores the own station's data link status. • OFF: Normal • ON: Error If an error occurs, the cause of the error can be checked by Cause of data link stop (SW0049). Depending on the timing of the link refresh, the update of Cause of data link stop (SW0049) may be offset by one sequence scan.	○	○
SB004A	Own station's CPU status (1)	Stores the continuation error status of the own station's CPU module. • OFF: Normal • ON: Continuation error	○	○
SB004B	Own station's CPU status (2)	Stores the stop error status of the own station's CPU module. • OFF: Normal • ON: Stop error	○	○
SB004C	CPU RUN status (own station)	Stores the RUN status of the own station's CPU module. • OFF: Normal • ON: Reset status, driver stop by H/W error	○	○
SB004D	Received parameter error	Stores the status of the received parameter. (own parameter status during master station) • OFF: Parameter normal • ON: Parameter error	○	○



Number	Name	Description	Availability	
			Master station	Local station
SB0050	Link start request accept status (own station)	Turns ON when a cyclic transmission start request by Link start (own station) (SB0000) is accepted. • OFF: Not accepted (SB0000 is OFF) • ON: Start accepted (SB0000 is ON) (Conditions) This is enabled when the Baton pass status (own station) (SB0047) is OFF.	○	○
SB0051	Link start completion status (own station)	Turns ON when the Link start request accept status (own station) (SB0050) turns ON, and cyclic transmission start is completed. • OFF: Start not completed (SB0000 is OFF) • ON: Start completed (SB0000 is ON) (Conditions) This is enabled when the Baton pass status (own station) (SB0047) is OFF.	○	○
SB0052	Link stop request accept status (own station)	Turns ON when a cyclic transmission stop request by Link stop (own station) (SB0001) is accepted. • OFF: Not accepted (SB0001 is OFF) • ON: Stop accepted (SB0001 is ON) (Conditions) This is enabled when the Baton pass status (own station) (SB0047) is OFF.	○	○
SB0053	Link stop completion status (own station)	Turns ON when Link stop request accept status (own station) (SB0052) turns ON, and the cyclic transmission stop is completed. • OFF: Stop not completed (SB0001 is OFF) • ON: Stop completed (SB0001 is ON) (Conditions) This is enabled when the Baton pass status (own station) (SB0047) is OFF.	○	○
SB0054	System link start request accept status	Turns ON when a cyclic transmission start request by System link start (SB0002) is accepted. • OFF: Not accepted (SB0002 is OFF) • ON: Start accepted (SB0002 is ON) (Conditions) This is enabled when the Baton pass status (own station) (SB0047) is OFF.	○	×
SB0055	System link start completion status	Turns ON when the System link start request accept status (SB0054) turns ON, and cyclic transmission start is completed. • OFF: Start not completed (SB0002 is OFF) • ON: Start completed (SB0002 is ON) (Conditions) This is enabled when the Baton pass status (own station) (SB0047) is OFF.	○	×
SB0056	System link stop request accept status	Turns ON when a cyclic transmission stop request by System link stop (SB0003) is accepted. • OFF: Not accepted (SB0003 is OFF) • ON: Stop accepted (SB0003 is ON) (Conditions) This is enabled when the Baton pass status (own station) (SB0047) is OFF.	○	×
SB0057	System link stop completion status	Turns ON when the System link stop accept status (SB0056) turns ON, and cyclic transmission stop is completed. • OFF: Stop not completed (SB0003 is OFF) • ON: Stop completed (SB0003 is ON) (Conditions) This is enabled when the Baton pass status (own station) (SB0047) is OFF.	○	×
SB0058	Temporary error invalid request accept status	Turns ON when the Temporary error invalid request (SB0010) is accepted. • OFF: Not accepted (SB0010 is OFF) • ON: Invalid accepted (SB0010 is ON)	○	○
SB0059	Temporary error invalid setting completion status	Turns ON when the Temporary error invalid request accept status (SB0058) is turned ON and the temporary error invalid processing is completed. • OFF: Not completed • ON: Completed or error completion	○	○
SB005A	Temporary error invalid setting cancel request accept status	Turns ON when the Temporary error invalid setting cancel request (SB0011) is accepted. • OFF: Not accepted • ON: Cancel accepted	○	○
SB005B	Temporary error invalid setting cancel completion status	Turns ON when the Temporary error invalid setting cancel request accept status (SB005A) is turned ON and the temporary error invalid setting cancel process is completed. • OFF: Not completed • ON: Completed or error completion	○	○

Number	Name	Description	Availability	
			Master station	Local station
SB005C	Reserved station function disable request accept status	Turns ON when the Reserved station function disable request (SB0012) is accepted. • OFF: Not accepted • ON: Cancel accepted	○	○
SB005D	Reserved station function disable completion status	Turns ON when the Reserved station function disable request accept status (SB005C) is turned ON and disabling the reserved station function is completed. • OFF: Not completed • ON: Completed or error completion	○	○
SB005E	Reserved station specification enable request accept status	Turns ON when the Reserved station specification enable request (SB0013) is accepted. • OFF: Not accepted • ON: Enable accepted	○	○
SB005F	Reserved station specification enabled status	Turns ON when the Reserved station specification enable request accept status (SB005E) is turned ON and the reserved station specification enable processing is completed. • OFF: Not completed • ON: Completed or error completion	○	○
SB0060	Constant link scan status	Stores the constant link scan status. • OFF: Constant link scan is disabled • ON: Constant link scan is enabled (Conditions) This is enabled when the Data link status (own station) (SB0049) is OFF.	○	○
SB0061	Event history clear acceptance status	Turns ON when Event count clear (SB0009) is accepted. • OFF: Not performed (SB0009 is OFF.) • ON: Direction accepted (SB0009 is ON.)	○	○
SB0062	Event history clear completion status	Turns ON when Event history clear acceptance status (SB0061) turns ON and the number of events is cleared. • OFF: Not performed (SB0009 is OFF.) • ON: Completed (SB0009 is ON.)	○	○
SB0065	Loopback status	Stores loopback execution status. The loopback station numbers can be checked by Loopback station number 1 (SW0070) and Loopback station number 2 (SW0071). • OFF: Normal (no loopback stations) • ON: Error (loopback being performed) (Loopback stations exist.) (Conditions) This relay is valid while Loopback function setting status (SB0078) is ON.	○	×
SB006A	PORT1 linkup status (own station)	Stores the linkup status of PORT1 (own station). • OFF: Linkup in progress • ON: Linkdown in progress The time that the linkup starts after power-on or Ethernet cable connection may vary. Normally, it takes a few seconds. Depending on device status on the line, a linkup process is repeated, resulting in the increase in the time.	○	○
SB006B	PORT2 linkup status (own station)	Stores the linkup status of PORT2 (own station). • OFF: Linkup in progress • ON: Linkdown in progress The time that the linkup starts after power-on or Ethernet cable connection may vary. Normally, it takes a few seconds. Depending on device status on the line, a linkup process is repeated, resulting in the increase in the time.	○	○
SB006C	PORT1 error frame reception status (own station) (1)	Stores if a receive frame error line status caution level has occurred in the own station's PORT1. • OFF: A receive frame error line status caution level has not yet been occurred. • ON: A receive frame error line status caution level has been occurred.	○	○
SB006D	PORT2 error frame reception status (own station) (1)	Stores if a receive frame error line status caution level has occurred in the own station's PORT2. • OFF: A receive frame error line status caution level has not yet been occurred. • ON: A receive frame error line status caution level has been occurred.	○	○
SB006E	PORT1 error frame reception detection status (own station) (latch) (1)	Stores if a receive frame error line status caution level has occurred in the own station's PORT1 from power-on until the present. • OFF: A receive frame error line status caution level has not yet been occurred. • ON: A receive frame error line status caution level has been occurred.	○	○
SB006F	PORT2 error frame reception detection status (own station) (latch) (1)	Stores if a receive frame error line status caution level has occurred in the own station's PORT2 from power-on until the present. • OFF: A receive frame error line status caution level has not yet been occurred. • ON: A receive frame error line status caution level has been occurred.	○	○



Number	Name	Description	Availability	
			Master station	Local station
SB0072	Scan mode setting information	Stores the scan mode setting status. • OFF: Asynchronous mode • ON: Synchronous mode	○	○
SB0074	Reserved station specification status	Stores the reserved station specification status due to parameters. The station number set for a reserved station can be checked by Reserved station specification (SW00C0 to SW00C7). • OFF: Not specified • ON: Specified	○	○
SB0075	Error invalid station setting status	Stores the Error invalid station setting status due to parameters. The station number set for the error invalid station can be checked by Error invalid station setting (SW00D0 to SW00D7). • OFF: Not specified • ON: Specified	○	○
SB0077	Parameter reception status	Stores the parameter reception status from the master station. • OFF: Reception completed • ON: Reception not completed	×	○
SB0078	Loopback function setting status	Stores the setting status of the loopback function configured by the parameter • OFF: Not used • ON: Used	○	×
SB007A	Event history status	Stores the network event history occurrence. • OFF: No event history • ON: Event history found If the event history is found, the cumulative number of network event history can be checked by the Event count (SW007A). Depending on the timing of the link refresh, the update of Event count (SW007A) may be offset by one sequence scan. This area is cleared when Event count clear (SB0009) is turned ON.	○	○
SB007B	Input data status of data link faulty station	Stores the own station's setting status for "Data Link Faulty Station Setting". • OFF: OFF or cleared to 0 • ON: Hold	○	○
SB007D	Hold/clear status setting for CPU STOP	Stores the own station's setting status for "Output Setting during CPU STOP". • OFF: Hold • ON: Clear (ALL OFF)	○	○
SB008C	PORT1 error frame reception status (own station) (2)	Stores if a receive frame error line status warning level has occurred in the own station's PORT1. • OFF: A receive frame error line status warning level has not yet been occurred. • ON: A receive frame error line status warning level has been occurred.	○	○
SB008D	PORT2 error frame reception status (own station) (2)	Stores if a receive frame error line status warning level has occurred in the own station's PORT2. • OFF: A receive frame error line status warning level has not yet been occurred. • ON: A receive frame error line status warning level has been occurred.	○	○
SB008E	PORT1 error frame reception detection status (own station) (latch) (2)	Stores if a receive frame error line status warning level has occurred in the own station's PORT1 from power-on until the present. • OFF: A receive frame error line status warning level has not yet been occurred. • ON: A receive frame error line status warning level has been occurred.	○	○
SB008F	PORT2 error frame reception detection status (own station) (latch) (2)	Stores if a receive frame error line status warning level has occurred in the own station's PORT2 from power-on until the present. • OFF: A receive frame error line status warning level has not yet been occurred. • ON: A receive frame error line status warning level has been occurred.	○	○
SB0090	Hardware test completion status	Stores the hardware test completion status. • OFF: Not executed or execution in progress • ON: Completed If completed, the completion status can be checked by Hardware test normal/abnormal end (SB0091).	○	○
SB0091	Hardware test normal/abnormal end	Stores the hardware test normal completion or abnormal completion status. • OFF: Normal completion • ON: Abnormal completion (Conditions) This is enabled when Hardware test completion status (SB0090) is ON.	○	○
SB0092	Self-loopback test completion status	Stores the self-loopback test completion status. • OFF: Not executed or execution in progress • ON: Completed If completed, the completion status can be checked by Self-loopback test normal/abnormal end (SB0093).	○	○

Number	Name	Description	Availability	
			Master station	Local station
SB0093	Self-loopback test normal/abnormal end	Stores the self-loopback test normal completion or abnormal completion status. • OFF: Normal completion • ON: Abnormal completion (Conditions) This is enabled when Self-loopback test completion status (SB0092) is ON.	○	○
SB0094	Loop test completion status	Stores the loop test completion status. • OFF: Not executed or execution in progress • ON: Completed If completed, the completion status can be checked by Loop test normal/abnormal end (SB0095).	○	×
SB0095	Loop test normal/abnormal end	Stores the loop test normal completion or abnormal completion status. • OFF: Normal completion • ON: Abnormal completion (Conditions) This is enabled when Loop test completion status (SB0094) is ON.	○	×
SB0098	Network configuration mismatch occurrence status	Stores the match or mismatch status of the actual network configuration and the network map of the CC-Link IE Field Network diagnostics. • OFF: Match • ON: Mismatch After return or addition of the device station, SB0098 may be turned ON regardless of the actual match/mismatch status.	○	×
SB0099	Number of connected modules over occurrence status	Stores whether the number of device stations (including a submaster station) connected is 120 or less, or 121 or more. • OFF: 120 or less • ON: 121 or more Number of connected modules is the total of the device stations (including a submaster station) which are currently connected and the disconnected stations (device stations which were previously connected).	○	×
SB009A	Loop test request accept status	Stores the loop test request accept status. • OFF: Loop test not accepted • ON: Loop test accepted The master station is turned ON during loop test mode. The device stations are turned ON during the loop test and turned OFF when the loop test is completed.	○	○
SB00A0	Baton pass status (each station)	Stores the baton pass status for each station. • OFF: All stations normal • ON: Faulty station found If a faulty station is found, the status of each station can be checked by Baton pass status (each station) (SW00A0 to SW00A7). Depending on the timing of the link refresh, the update of Baton pass status (each station) (SW00A0 to SW00A7) may be offset by one sequence scan. (Conditions) • This is enabled when the Baton pass status (own station) (SB0047) is OFF. • Reserved stations and stations higher than the maximum station number are ignored.	○	○
SB00A1	Baton pass status (master station)	Stores the baton pass status for master station. • OFF: Normal • ON: Error (Conditions) This is enabled when the Baton pass status (own station) (SB0047) is OFF.	○	○
SB00B0	Data link status (each station)	Stores the cyclic transmission status for each station. • OFF: Cyclic transmission for all stations in progress • ON: Cyclic transmission not executed for some stations If cyclic transmission are not executed for some stations, the status of each station can be checked by Data link status (each station) (SW00B0 to SW00B7). Depending on the timing of the link refresh, the update of Data link status (each station) (SW00B0 to SW00B7) may be offset by one sequence scan. (Conditions) • This is enabled when the Baton pass status (own station) (SB0047) is OFF. • Reserved stations and stations higher than the maximum station number are ignored.	○	○



Number	Name	Description	Availability	
			Master station	Local station
SB00B1	Data link status (master station)	Stores the cyclic transmission status for the master station. <ul style="list-style-type: none"> <li>• OFF: Normal</li> <li>• ON: Error</li> </ul> (Conditions) This is enabled when the Baton pass status (own station) (SB0047) is OFF.	○	○
SB00B8	Network connection status (each station)	Stores if any network connection station is found. <ul style="list-style-type: none"> <li>• OFF: No network connection station</li> <li>• ON: Network connection station found</li> </ul> If a network connection station is found, the status of each station can be checked using Network connection status (SW00B8 to SW00BF). Depending on the timing of the link refresh, the update of Network connection status (SW00B8 to SW00BF) may be offset by one sequence scan.	○	○
SB00C0	Reserved station specification	Stores if there are any reserved stations. <ul style="list-style-type: none"> <li>• OFF: No reserved stations</li> <li>• ON: Reserved stations found</li> </ul> If a reserved station is found, the status of each station can be checked by Reserved station specification (SW00C0 to SW00C7). Depending on the timing of the link refresh, the update of Reserved station specification (SW00C0 to SW00C7) may be offset by one sequence scan. (Conditions) This is enabled when the Baton pass status (own station) (SB0047) is OFF.	○	○
SB00D0	Error invalid station setting	Stores if there are any error invalid stations. <ul style="list-style-type: none"> <li>• OFF: No error invalid stations</li> <li>• ON: Error invalid station found</li> </ul> If an error invalid station is found, the status of each station can be checked by Error invalid station setting (SW00D0 to SW00D7). Depending on the timing of the link refresh, the update of Error invalid station setting (SW00D0 to SW00D7) may be offset by one sequence scan. (Conditions) This is enabled when the Baton pass status (own station) (SB0047) is OFF.	○	○
SB00E0	Temporary error invalid station status	Stores if there are any temporary error invalid stations. <ul style="list-style-type: none"> <li>• OFF: No temporary error invalid stations</li> <li>• ON: Temporary error invalid station found</li> </ul> If a temporary error invalid station is found, the status of each station can be checked by Temporary error invalid station setting (SW00E0 to SW00E7). Depending on the timing of the link refresh, the update of Temporary error invalid station setting (SW00E0 to SW00E7) may be offset by one sequence scan. (Conditions) This is enabled when the Baton pass status (own station) (SB0047) is OFF.	○	○
SB00E8	Station type match status (each station)	Stores the station type match status of each station. <ul style="list-style-type: none"> <li>• OFF: Station type match in all stations</li> <li>• ON: Station type mismatch station found</li> </ul> If a station type mismatch station is found, the status of each station can be checked using Station type match status (SW00E8 to SW00EF). Depending on the timing of the link refresh, the update of Station type match status (SW00E8 to SW00EF) may be offset by one sequence scan.	○	○
SB00F0	CPU RUN status (each station)	Stores the RUN status of each station's CPU module. <ul style="list-style-type: none"> <li>• OFF: All stations are in RUN or STEP-RUN status</li> <li>• ON: Station in STOP or PAUSE status found</li> </ul> If a station in STOP or PAUSE status is found, the status of each station can be checked by the CPU RUN status (each station) (SW00F0 to SW00F7). Depending on the timing of the link refresh, the update of CPU RUN status (each station) (SW00F0 to SW00F7) may be offset by one sequence scan. (Conditions) This is enabled when the Baton pass status (own station) (SB0047) is OFF.	○	○
SB00F1	CPU RUN status (master station)	Stores the RUN status of the master station's CPU module. <ul style="list-style-type: none"> <li>• OFF: RUN or STEP-RUN status</li> <li>• ON: STOP or PAUSE status</li> </ul> (Conditions) This is enabled when the Baton pass status (own station) (SB0047) is OFF.	○	○

Number	Name	Description	Availability	
			Master station	Local station
SB00F8	Network number match status	Stores the network number match status of each station. <ul style="list-style-type: none"> <li>• OFF: Network number match in all stations</li> <li>• ON: Network number mismatch station found</li> </ul> If a network number mismatch station is found, the status of each station can be checked using Network number match status (SW00F8 to SW00FF). Depending on the timing of the link refresh, the update of Network number match status (SW00F8 to SW00FF) may be offset by one sequence scan. (Conditions) This is enabled when the Baton pass status (own station) (SB0047) is OFF.	○	○
SB0100	Operation status (each station) (1)	Stores the moderate/major error or stop error status of each station. When the target station is the master/local module, the occurrence status on the control CPU is stored. <ul style="list-style-type: none"> <li>• OFF: No moderate/major error (stop error)</li> <li>• ON: Station with a moderate/major error (stop error) exists</li> </ul> If a station with a moderate/major error (stop error) is found, the status of each station can be checked with Operation status (each station) (1) (SW0100 to SW0107). Depending on the timing of the link refresh, the update of Operation status (each station) (1) (SW0100 to SW0107) may be offset by one sequence scan. (Conditions) This is enabled when the Baton pass status (own station) (SB0047) is OFF.	○	○
SB0101	CPU operation status (master station) (1)	Stores the stop error status of the master station's CPU module. <ul style="list-style-type: none"> <li>• OFF: Normal</li> <li>• ON: Stop error occurred</li> </ul> (Conditions) This is enabled when the Baton pass status (own station) (SB0047) is OFF.	○	○
SB0108	Station number duplication occurrence status	Stores the station number duplication occurrence status of each station. <ul style="list-style-type: none"> <li>• OFF: No duplication of station number</li> <li>• ON: Station number duplicated</li> </ul> If a station number is duplicated, the status of each station can be checked using Station number duplication occurrence status (SW0108 to SW010F). Depending on the timing of the link refresh, the update of Station number duplication occurrence status (SW0108 to SW010F) may be offset by one sequence scan. (Conditions) This is enabled when the Baton pass status (own station) (SB0047) is OFF.	○	○
SB0110	Operation status (each station) (2)	Stores the minor error or continuation error status of each station. When the target station is the master/local module, the occurrence status on the control CPU is stored. <ul style="list-style-type: none"> <li>• OFF: All stations normal or station with a moderate/major error(stop error) exists</li> <li>• ON: Station with a minor error (continuation error) exists</li> </ul> If a station with a minor error (continuation error) is found, the status of each station can be checked by Operation status (each station) (2) (SW0110 to SW0117). Depending on the timing of the link refresh, the update of Operation status (each station) (2) (SW0110 to SW0117) may be offset by one sequence scan. (Conditions) This is enabled when the Baton pass status (own station) (SB0047) is OFF.	○	○
SB0111	CPU operation status (master station) (2)	Stores the continuation error status of the master station's CPU module. <ul style="list-style-type: none"> <li>• OFF: Normal</li> <li>• ON: Continuation error occurred</li> </ul> (Conditions) This is enabled when the Baton pass status (own station) (SB0047) is OFF.	○	○
SB0120	PORT1 current error frame reception status (1)	Stores if a receive frame error line status caution level has occurred in each station's PORT1. <ul style="list-style-type: none"> <li>• OFF: A receive frame error line status caution level has not yet been occurred in any stations.</li> <li>• ON: A receive frame error line status caution level has been occurred in one or more stations.</li> </ul> If a receive frame error line status caution level has been occurred, the status of each station can be checked by PORT1 current error frame reception status (each station) (1) (SW0120 to SW0127). Depending on the timing of the link refresh, the update of PORT1 current error frame reception status (each station) (1) (SW0120 to SW0127) may be offset by one sequence scan. (Conditions) This is enabled when the Baton pass status (own station) (SB0047) is OFF.	○	○



Number	Name	Description	Availability	
			Master station	Local station
SB0121	PORT1 error frame reception status (master station)	Stores if an error frame is received at the master station's PORT1. <ul style="list-style-type: none"> <li>• OFF: An error frame has not yet been received</li> <li>• ON: An error frame has been received</li> </ul> (Conditions) This is enabled when the Baton pass status (own station) (SB0047) is OFF.	<input type="radio"/>	<input type="radio"/>
SB0128	PORT1 current error frame reception status (2)	Stores if a receive frame error line status warning level has occurred in each station's PORT1. <ul style="list-style-type: none"> <li>• OFF: A receive frame error line status warning level has not yet been occurred in any stations.</li> <li>• ON: A receive frame error line status warning level has been occurred in one or more stations.</li> </ul> If a receive frame error line status warning level has been occurred, the status of each station can be checked by PORT1 current error frame reception status (each station) (2) (SW0128 to SW012F). Depending on the timing of the link refresh, the update of PORT1 current error frame reception status (each station) (2) (SW0128 to SW012F) may be offset by one sequence scan. (Conditions) This is enabled when the Baton pass status (own station) (SB0047) is OFF.	<input type="radio"/>	<input type="radio"/>
SB0130	PORT2 current error frame reception status (1)	Stores if a receive frame error line status caution level has occurred in each station's PORT2. <ul style="list-style-type: none"> <li>• OFF: A receive frame error line status caution level has not yet been occurred in any stations.</li> <li>• ON: A receive frame error line status caution level has been occurred in one or more stations.</li> </ul> If a receive frame error line status caution level has been occurred, the status of each station can be checked by PORT2 current error frame reception status (each station) (1) (SW0130 to SW0137). Depending on the timing of the link refresh, the update of PORT2 current error frame reception status (each station) (1) (SW0130 to SW0137) may be offset by one sequence scan. (Conditions) This is enabled when the Baton pass status (own station) (SB0047) is OFF.	<input type="radio"/>	<input type="radio"/>
SB0131	PORT2 error frame reception status (master station)	Stores if an error frame is received at the master station's PORT2. <ul style="list-style-type: none"> <li>• OFF: An error frame has not yet been received</li> <li>• ON: An error frame has been received</li> </ul> (Conditions) This is enabled when the Baton pass status (own station) (SB0047) is OFF.	<input type="radio"/>	<input type="radio"/>
SB0138	PORT2 current error frame reception status (2)	Stores if a receive frame error line status warning level has occurred in each station's PORT2. <ul style="list-style-type: none"> <li>• OFF: A receive frame error line status warning level has not yet been occurred in any stations.</li> <li>• ON: A receive frame error line status warning level has been occurred in one or more stations.</li> </ul> If a receive frame error line status warning level has been occurred, the status of each station can be checked by PORT2 current error frame reception status (each station) (2) (SW0138 to SW013F). Depending on the timing of the link refresh, the update of PORT2 current error frame reception status (each station) (2) (SW0138 to SW013F) may be offset by one sequence scan. (Conditions) This is enabled when the Baton pass status (own station) (SB0047) is OFF.	<input type="radio"/>	<input type="radio"/>
SB0140	PORT1 error frame reception detection status (1)	Stores if a receive frame error line status caution level has occurred in each station's PORT1 from power-on until the present. <ul style="list-style-type: none"> <li>• OFF: A receive frame error line status caution level has not yet been occurred in any stations.</li> <li>• ON: A receive frame error line status caution level has been occurred in one or more stations.</li> </ul> If a receive frame error line status caution level has been occurred, the status of each station can be checked by PORT1 error frame reception detection status (1) (SW0140 to SW0147). Depending on the timing of the link refresh, the update of PORT1 error frame reception detection status (1) (SW0140 to SW0147) may be offset by one sequence scan. (Conditions) This is enabled when the Baton pass status (own station) (SB0047) is OFF.	<input type="radio"/>	<input type="radio"/>

Number	Name	Description	Availability	
			Master station	Local station
SB0141	PORT1 error frame detection (master station)	Stores if an error frame is received from power-on until the present at the master station's PORT1. <ul style="list-style-type: none"> <li>• OFF: An error frame has not yet been received</li> <li>• ON: An error frame has been received at least once</li> </ul> (Conditions) This is enabled when the Baton pass status (own station) (SB0047) is OFF.	<input type="radio"/>	<input type="radio"/>
SB0148	PORT1 error frame reception detection status (2)	Stores if a receive frame error line status warning level has occurred in each station's PORT1 from power-on until the present. <ul style="list-style-type: none"> <li>• OFF: A receive frame error line status warning level has not yet been occurred in any stations.</li> <li>• ON: A receive frame error line status warning level has been occurred in one or more stations.</li> </ul> If a receive frame error line status warning level has been occurred, the status of each station can be checked by PORT1 error frame reception detection status (2) (SW0148 to SW014F). Depending on the timing of the link refresh, the update of PORT1 error frame reception detection status (2) (SW0148 to SW014F) may be offset by one sequence scan. (Conditions) This is enabled when the Baton pass status (own station) (SB0047) is OFF.	<input type="radio"/>	<input type="radio"/>
SB0150	PORT2 error frame reception detection status (1)	Stores if a receive frame error line status caution level has occurred in each station's PORT2 from power-on until the present. <ul style="list-style-type: none"> <li>• OFF: A receive frame error line status caution level has not yet been occurred in any stations.</li> <li>• ON: A receive frame error line status caution level has been occurred in one or more stations.</li> </ul> If a receive frame error line status caution level has been occurred, the status of each station can be checked by PORT2 error frame reception detection status (1) (SW0150 to SW0157). Depending on the timing of the link refresh, the update of PORT2 error frame reception detection status (1) (SW0150 to SW0157) may be offset by one sequence scan. (Conditions) This is enabled when the Baton pass status (own station) (SB0047) is OFF.	<input type="radio"/>	<input type="radio"/>
SB0151	PORT2 error frame detection (master station)	Stores if an error frame is received from power-on until the present at the master station's PORT2. <ul style="list-style-type: none"> <li>• OFF: An error frame has not yet been received</li> <li>• ON: An error frame has been received at least once</li> </ul> (Conditions) This is enabled when the Baton pass status (own station) (SB0047) is OFF.	<input type="radio"/>	<input type="radio"/>
SB0158	PORT2 error frame reception detection status (2)	Stores if a receive frame error line status warning level has occurred in each station's PORT2 from power-on until the present. <ul style="list-style-type: none"> <li>• OFF: A receive frame error line status warning level has not yet been occurred in any stations.</li> <li>• ON: A receive frame error line status warning level has been occurred in one or more stations.</li> </ul> If a receive frame error line status warning level has been occurred, the status of each station can be checked by PORT2 error frame reception detection status (2) (SW0158 to SW015F). Depending on the timing of the link refresh, the update of PORT2 error frame reception detection status (2) (SW0158 to SW015F) may be offset by one sequence scan. (Conditions) This is enabled when the Baton pass status (own station) (SB0047) is OFF.	<input type="radio"/>	<input type="radio"/>
SB0170	Parameter error status (each station)	Stores the parameter status for each station. <ul style="list-style-type: none"> <li>• OFF: No parameter errors for any stations</li> <li>• ON: Parameter error detected at one or more stations</li> </ul> If a parameter error occurs, the status of each station can be checked by the Parameter error status (each station) (SW0170 to SW0177). Depending on the timing of the link refresh, the update of Parameter error status (each station) (SW0170 to SW0177) may be offset by one sequence scan. (Conditions) <ul style="list-style-type: none"> <li>• This is enabled when the Baton pass status (own station) (SB0047) is OFF.</li> <li>• Reserved stations and stations higher than the maximum station number are ignored.</li> </ul>	<input type="radio"/>	<input type="radio"/>

Number	Name	Description	Availability	
			Master station	Local station
SB0180	Reserved station function disable status	<p>This stores if a reserved station function is disabled.</p> <ul style="list-style-type: none"> <li>• OFF: No disabled reserved station function</li> <li>• ON: Disabled reserved station function found</li> </ul> <p>If a reserved station function is disabled, the status of each station can be checked by the Reserved station function disable status (SW0180 to SW0187). Depending on the timing of the link refresh, the update of Reserved station function disable status (SW0180 to SW0187) may be offset by one sequence scan. (Conditions)</p> <p>This is enabled when the Baton pass status (own station) (SB0047) is OFF.</p>	<input type="radio"/>	<input type="radio"/>

# Appendix 4 Link Special Register (SW) List

Link special registers (SW) store information during data link as numerical values. Error locations and causes can be checked by using and monitoring link special registers (SW) in programs.

## Application of link special registers (SW)

By using link special registers (SW), the status of the CC-Link IE Field Network can be checked.

## Ranges of areas that are turned ON/OFF by users and by the system

The following is a range when the link special register (SW) is assigned from SW0000 to SW01FF.

- Range where data are stored by users: SW0000 to SW001F
- Range where data are stored by the system: SW0020 to SW01FF

## Link special register (SW) list

A list of link special registers (SW) when they are assigned from SW0000 to SW01FF is described as follows.



Do not write any data to an area whose number is not on the link special register (SW) list. Doing so may cause malfunction of the programmable controller system.

Number	Name	Description	Availability																																																																																																																																																										
			Master station	Local station																																																																																																																																																									
SW0000	Link stop/start direction	Sets the station where cyclic transmission is stopped or started. <ul style="list-style-type: none"> <li>• 00H: Own station</li> <li>• 01H: All stations</li> <li>• 02H: Specified station</li> <li>• 80H: Own station (Forced link start)</li> <li>• 81H: All stations (Forced link start)</li> <li>• 82H: Specified station (Forced link start)</li> </ul> Stopping/starting of cyclic transmission is performed by System link start (SB0002) or System link stop (SB0003). <ul style="list-style-type: none"> <li>• When Specified station (02H or 82H) is selected, the own station is not included.</li> </ul>	○	×																																																																																																																																																									
SW0001 to SW0008	Link stop/start direction	When setting 02H or 82H by the Link stop/start direction (SW0000), this sets the station number that stops or starts cyclic transmission. <ul style="list-style-type: none"> <li>• 0: No direction issued for stop or start</li> <li>• 1: Direction issued for stop or start</li> </ul> <table border="1" style="margin-left: auto; margin-right: auto;"> <thead> <tr> <th></th> <th>b15</th><th>b14</th><th>b13</th><th>b12</th><th>b11</th><th>b10</th><th>b9</th><th>b8</th><th>b7</th><th>b6</th><th>b5</th><th>b4</th><th>b3</th><th>b2</th><th>b1</th><th>b0</th> </tr> </thead> <tbody> <tr> <td>SW0001</td> <td>16</td><td>15</td><td>14</td><td>13</td><td>12</td><td>11</td><td>10</td><td>9</td><td>8</td><td>7</td><td>6</td><td>5</td><td>4</td><td>3</td><td>2</td><td>1</td> </tr> <tr> <td>SW0002</td> <td>32</td><td>31</td><td>30</td><td>29</td><td>28</td><td>27</td><td>26</td><td>25</td><td>24</td><td>23</td><td>22</td><td>21</td><td>20</td><td>19</td><td>18</td><td>17</td> </tr> <tr> <td>SW0003</td> <td>48</td><td>47</td><td>46</td><td>45</td><td>44</td><td>43</td><td>42</td><td>41</td><td>40</td><td>39</td><td>38</td><td>37</td><td>36</td><td>35</td><td>34</td><td>33</td> </tr> <tr> <td>SW0004</td> <td>64</td><td>63</td><td>62</td><td>61</td><td>60</td><td>59</td><td>58</td><td>57</td><td>56</td><td>55</td><td>54</td><td>53</td><td>52</td><td>51</td><td>50</td><td>49</td> </tr> <tr> <td>SW0005</td> <td>80</td><td>79</td><td>78</td><td>77</td><td>76</td><td>75</td><td>74</td><td>73</td><td>72</td><td>71</td><td>70</td><td>69</td><td>68</td><td>67</td><td>66</td><td>65</td> </tr> <tr> <td>SW0006</td> <td>96</td><td>95</td><td>94</td><td>93</td><td>92</td><td>91</td><td>90</td><td>89</td><td>88</td><td>87</td><td>86</td><td>85</td><td>84</td><td>83</td><td>82</td><td>81</td> </tr> <tr> <td>SW0007</td> <td>112</td><td>111</td><td>110</td><td>109</td><td>108</td><td>107</td><td>106</td><td>105</td><td>104</td><td>103</td><td>102</td><td>101</td><td>100</td><td>99</td><td>98</td><td>97</td> </tr> <tr> <td>SW0008</td> <td>—</td><td>—</td><td>—</td><td>—</td><td>—</td><td>—</td><td>—</td><td>—</td><td>120</td><td>119</td><td>118</td><td>117</td><td>116</td><td>115</td><td>114</td><td>113</td> </tr> </tbody> </table> <p style="text-align: center;">Each number in the table represents station No.</p>		b15	b14	b13	b12	b11	b10	b9	b8	b7	b6	b5	b4	b3	b2	b1	b0	SW0001	16	15	14	13	12	11	10	9	8	7	6	5	4	3	2	1	SW0002	32	31	30	29	28	27	26	25	24	23	22	21	20	19	18	17	SW0003	48	47	46	45	44	43	42	41	40	39	38	37	36	35	34	33	SW0004	64	63	62	61	60	59	58	57	56	55	54	53	52	51	50	49	SW0005	80	79	78	77	76	75	74	73	72	71	70	69	68	67	66	65	SW0006	96	95	94	93	92	91	90	89	88	87	86	85	84	83	82	81	SW0007	112	111	110	109	108	107	106	105	104	103	102	101	100	99	98	97	SW0008	—	—	—	—	—	—	—	—	120	119	118	117	116	115	114	113	○	×
	b15	b14	b13	b12	b11	b10	b9	b8	b7	b6	b5	b4	b3	b2	b1	b0																																																																																																																																													
SW0001	16	15	14	13	12	11	10	9	8	7	6	5	4	3	2	1																																																																																																																																													
SW0002	32	31	30	29	28	27	26	25	24	23	22	21	20	19	18	17																																																																																																																																													
SW0003	48	47	46	45	44	43	42	41	40	39	38	37	36	35	34	33																																																																																																																																													
SW0004	64	63	62	61	60	59	58	57	56	55	54	53	52	51	50	49																																																																																																																																													
SW0005	80	79	78	77	76	75	74	73	72	71	70	69	68	67	66	65																																																																																																																																													
SW0006	96	95	94	93	92	91	90	89	88	87	86	85	84	83	82	81																																																																																																																																													
SW0007	112	111	110	109	108	107	106	105	104	103	102	101	100	99	98	97																																																																																																																																													
SW0008	—	—	—	—	—	—	—	—	120	119	118	117	116	115	114	113																																																																																																																																													
SW0009	Arrival monitoring time (RIRD/RIWT)	Specify the monitoring time until instruction completion. <p>If the direction is not completed within the time, it is resent for the number of resends specified by the Number of resends (RIRD/RIWT) (SW000B).</p> <ul style="list-style-type: none"> <li>• 0: 10 seconds (default value)</li> <li>• 1 to 360: 1 to 360 seconds</li> </ul> <p>If a value outside the above settings is made, operation is performed for 360 seconds. If the Number of resends (RIRD/RIWT) (SW000B) is set, the time until the dedicated instruction fails is shown below.</p> <p>(Number of resends (RIRD/RIWT) + 1) × Arrival monitoring time (RIRD/RIWT)</p>	○	○																																																																																																																																																									



Number	Name	Description	Availability																																																																																																																																																										
			Master station	Local station																																																																																																																																																									
SW000B	Number of resends (RIRD/RIWT)	<p>If the instruction is not completed within the monitoring time specified by the Arrival monitoring time (RIRD/RIWT) (SW0009), this specifies the number of times that the instruction is resent.</p> <ul style="list-style-type: none"> <li>• 0: Not resent (default value)</li> <li>• 1 to 7: 1 to 7 times</li> </ul> <p>If a value outside the above settings is made, the instruction is resent 7 times.</p>	○	○																																																																																																																																																									
SW0010 to SW0017	Reserved station function disable/ temporary error invalid station setting	<p>Specifies the device stations where reserved station function disable or temporary error invalid station setting/cancel is performed.</p> <ul style="list-style-type: none"> <li>• 0: Not specified</li> <li>• 1: Specified</li> </ul> <table border="1" style="margin-left: 40px;"> <thead> <tr> <th></th> <th>b15</th><th>b14</th><th>b13</th><th>b12</th><th>b11</th><th>b10</th><th>b9</th><th>b8</th><th>b7</th><th>b6</th><th>b5</th><th>b4</th><th>b3</th><th>b2</th><th>b1</th><th>b0</th> </tr> </thead> <tbody> <tr> <td>SW0010</td> <td>16</td><td>15</td><td>14</td><td>13</td><td>12</td><td>11</td><td>10</td><td>9</td><td>8</td><td>7</td><td>6</td><td>5</td><td>4</td><td>3</td><td>2</td><td>1</td> </tr> <tr> <td>SW0011</td> <td>32</td><td>31</td><td>30</td><td>29</td><td>28</td><td>27</td><td>26</td><td>25</td><td>24</td><td>23</td><td>22</td><td>21</td><td>20</td><td>19</td><td>18</td><td>17</td> </tr> <tr> <td>SW0012</td> <td>48</td><td>47</td><td>46</td><td>45</td><td>44</td><td>43</td><td>42</td><td>41</td><td>40</td><td>39</td><td>38</td><td>37</td><td>36</td><td>35</td><td>34</td><td>33</td> </tr> <tr> <td>SW0013</td> <td>64</td><td>63</td><td>62</td><td>61</td><td>60</td><td>59</td><td>58</td><td>57</td><td>56</td><td>55</td><td>54</td><td>53</td><td>52</td><td>51</td><td>50</td><td>49</td> </tr> <tr> <td>SW0014</td> <td>80</td><td>79</td><td>78</td><td>77</td><td>76</td><td>75</td><td>74</td><td>73</td><td>72</td><td>71</td><td>70</td><td>69</td><td>68</td><td>67</td><td>66</td><td>65</td> </tr> <tr> <td>SW0015</td> <td>96</td><td>95</td><td>94</td><td>93</td><td>92</td><td>91</td><td>90</td><td>89</td><td>88</td><td>87</td><td>86</td><td>85</td><td>84</td><td>83</td><td>82</td><td>81</td> </tr> <tr> <td>SW0016</td> <td>112</td><td>111</td><td>110</td><td>109</td><td>108</td><td>107</td><td>106</td><td>105</td><td>104</td><td>103</td><td>102</td><td>101</td><td>100</td><td>99</td><td>98</td><td>97</td> </tr> <tr> <td>SW0017</td> <td>—</td><td>—</td><td>—</td><td>—</td><td>—</td><td>—</td><td>—</td><td>—</td><td>120</td><td>119</td><td>118</td><td>117</td><td>116</td><td>115</td><td>114</td><td>113</td> </tr> </tbody> </table> <p style="margin-left: 40px;">Each number in the table represents station No.</p> <p>(Conditions)</p> <ul style="list-style-type: none"> <li>• Some stations cannot be specified as reserved station function disable or temporary error invalid station setting/cancel. (☞ Page 143 Reserved station function enable, Page 144 Enable/Disable ignore station errors)</li> <li>• Stations higher than the maximum station number are ignored.</li> </ul>		b15	b14	b13	b12	b11	b10	b9	b8	b7	b6	b5	b4	b3	b2	b1	b0	SW0010	16	15	14	13	12	11	10	9	8	7	6	5	4	3	2	1	SW0011	32	31	30	29	28	27	26	25	24	23	22	21	20	19	18	17	SW0012	48	47	46	45	44	43	42	41	40	39	38	37	36	35	34	33	SW0013	64	63	62	61	60	59	58	57	56	55	54	53	52	51	50	49	SW0014	80	79	78	77	76	75	74	73	72	71	70	69	68	67	66	65	SW0015	96	95	94	93	92	91	90	89	88	87	86	85	84	83	82	81	SW0016	112	111	110	109	108	107	106	105	104	103	102	101	100	99	98	97	SW0017	—	—	—	—	—	—	—	—	120	119	118	117	116	115	114	113	○	×
	b15	b14	b13	b12	b11	b10	b9	b8	b7	b6	b5	b4	b3	b2	b1	b0																																																																																																																																													
SW0010	16	15	14	13	12	11	10	9	8	7	6	5	4	3	2	1																																																																																																																																													
SW0011	32	31	30	29	28	27	26	25	24	23	22	21	20	19	18	17																																																																																																																																													
SW0012	48	47	46	45	44	43	42	41	40	39	38	37	36	35	34	33																																																																																																																																													
SW0013	64	63	62	61	60	59	58	57	56	55	54	53	52	51	50	49																																																																																																																																													
SW0014	80	79	78	77	76	75	74	73	72	71	70	69	68	67	66	65																																																																																																																																													
SW0015	96	95	94	93	92	91	90	89	88	87	86	85	84	83	82	81																																																																																																																																													
SW0016	112	111	110	109	108	107	106	105	104	103	102	101	100	99	98	97																																																																																																																																													
SW0017	—	—	—	—	—	—	—	—	120	119	118	117	116	115	114	113																																																																																																																																													
SW001A	Number of resends (REMF/REMTO)	<p>Specifies the number of resends for the REMFR/REMTO instruction.</p> <ul style="list-style-type: none"> <li>• 0: 0 times (default)</li> <li>• Outside the above: Number of times that is set</li> </ul> <p>(Conditions)</p> <p>This is enabled when the Baton pass status (own station) (SB0047) is OFF.</p>	○	×																																																																																																																																																									
SW001B	Response wait timer (REMF/REMTO)	<p>Specifies the response wait time for the REMFR/REMTO instruction.</p> <ul style="list-style-type: none"> <li>• 0: 10 seconds (default)</li> <li>• Outside the above: Number of seconds that is set</li> </ul> <p>(Conditions)</p> <p>This is enabled when the Baton pass status (own station) (SB0047) is OFF.</p>	○	×																																																																																																																																																									
SW0030	Send/receive instruction (1) processing result	<p>Stores the processing results of the link dedicated instruction that used the own station's channel 1.</p> <ul style="list-style-type: none"> <li>• 0: Normal completion</li> <li>• 1 or higher: Abnormal completion (☞ Page 177 Error Code List)</li> </ul>	○	○																																																																																																																																																									
SW0031	Send/receive instruction (2) processing result	<p>Stores the processing results of the link dedicated instruction that used the own station's channel 2.</p> <ul style="list-style-type: none"> <li>• 0: Normal completion</li> <li>• 1 or higher: Abnormal completion (☞ Page 177 Error Code List)</li> </ul>	○	○																																																																																																																																																									
SW0040	Network number	<p>Stores the network number of own station.</p> <ul style="list-style-type: none"> <li>• Range: 1 to 239</li> </ul>	○	○																																																																																																																																																									
SW0042	Station number	<p>Stores the station number of own station.</p> <ul style="list-style-type: none"> <li>• Range: 1 to 120 (master station: 125)</li> </ul>	○	○																																																																																																																																																									
SW0043	Mode status	<p>Stores the mode of own station.</p> <ul style="list-style-type: none"> <li>• 0: Online (Normal Mode) (Local station: Online)</li> <li>• 1: Online (High Speed Mode)</li> <li>• 2: Offline</li> <li>• 6: Loop test</li> <li>• 7: Self-loopback test</li> <li>• 9: Hardware test</li> </ul>	○	○																																																																																																																																																									
SW0046	Module type	<p>Stores the own station's hardware status.</p> <div style="margin-left: 40px;"> <table border="1" style="border-collapse: collapse;"> <tr> <td style="width: 100px;">b15</td> <td style="width: 100px;">to</td> <td style="width: 100px;">b2</td> <td style="width: 100px;">b1</td> <td style="width: 100px;">b0</td> </tr> <tr> <td>0</td> <td>to</td> <td>0</td> <td style="background-color: #cccccc;"></td> <td style="background-color: #cccccc;"></td> </tr> </table> <p>Module type 00: Module 01: Board 10: HMI</p> </div>	b15	to	b2	b1	b0	0	to	0			○	○																																																																																																																																															
b15	to	b2	b1	b0																																																																																																																																																									
0	to	0																																																																																																																																																											

Number	Name	Description	Availability	
			Master station	Local station
SW0047	Baton pass status (own station)	Stores the baton pass status for the own station (transient transmission possible). <ul style="list-style-type: none"> <li>• 0: Data link in progress</li> <li>• 2: Baton pass in progress</li> <li>• 3: Baton pass stopped</li> <li>• 4: Test in progress</li> <li>• 5: Offline</li> </ul>	○	○
SW0048	Cause of baton pass interruption	Stores the cause of interruption in the communication (baton pass) of own station. <ul style="list-style-type: none"> <li>• 00H: At normal communication or power-on</li> <li>• 30H: Cable disconnection</li> <li>• 33H: Disconnection or reconnection in progress</li> <li>• 40H: Offline mode</li> <li>• 41H: Hardware test</li> <li>• 42H: Self-loopback test</li> </ul>	○	○
SW0049	Cause of data link stop	Stores the cause which stopped the data link of own station. <ul style="list-style-type: none"> <li>• 00H: At normal communication or power-on</li> <li>• 01H: Stop command issued</li> <li>• 02H: Monitoring timeout</li> <li>• 05H: No device stations (master station only)</li> <li>• 10H: Parameter not received (local stations only)</li> <li>• 11H: Own station number out of range</li> <li>• 12H: Own station specified as reserved</li> <li>• 13H: Station number duplication (own station)</li> <li>• 14H: Master station duplication</li> <li>• 16H: Station number not set</li> <li>• 18H: Parameter error</li> <li>• 19H: Parameter communication in progress</li> <li>• 1AH: Station type mismatch</li> <li>• 20H: CPU module stop error</li> <li>• 60H: Incorrect ring topology configuration (master station only)</li> </ul>	○	○
SW004A	Data link stop request station	Stores the station number of the station that performed the cyclic transmission stop request for the own station. <ul style="list-style-type: none"> <li>• Range: 125 (master station), 1 to 120 (local station)</li> </ul> The cyclic transmission stop request is performed by System link stop (SB0003). (Conditions) This is enabled when the Baton pass status (own station) (SB0047) is OFF.	○	○
SW004B	Own station's CPU status	Stores the own station's status. <ul style="list-style-type: none"> <li>• 00H: No module mounted</li> <li>• 01H: STOP (Normal)</li> <li>• 02H: STOP (Stop error occurring)</li> <li>• 03H: STOP (Continuation error occurring)</li> <li>• 04H: RUN (Normal)</li> <li>• 05H: RUN (Continuation error occurring)</li> <li>• 06H: STEP-RUN</li> <li>• 07H: PAUSE</li> <li>• 0EH: Reset in progress</li> <li>• 0FH: Initial processing</li> </ul>	○	○
SW004C	Parameter setting status	Stores the parameter status. <ul style="list-style-type: none"> <li>• 0: Normal</li> <li>• 1 or higher: Abnormal (☞ Page 177 Error Code List)</li> </ul> (Conditions) This is enabled when the Received parameter error (SB004D) is ON.	○	○
SW0050	Data link start status (own station)	Stores the results when cyclic transmission is started by Link start (own station) (SB0000). <ul style="list-style-type: none"> <li>• 0: Normal</li> <li>• 1 or higher: Abnormal (☞ Page 177 Error Code List)</li> </ul> When Link start (own station) (SB0000) is turned OFF, the stored error definition is cleared. (Conditions) This is enabled when the Baton pass status (own station) (SB0047) is OFF.	○	○



Number	Name	Description	Availability	
			Master station	Local station
SW0051	Data link stop status (own station)	Stores the results when cyclic transmission is stopped by Link stop (own station) (SB0001). • 0: Normal • 1 or higher: Abnormal ( Page 177 Error Code List) When Link stop (own station) (SB0001) is turned OFF, the stored error definition is cleared. (Conditions) This is enabled when the Baton pass status (own station) (SB0047) is OFF.	○	○
SW0052	Data link start status (entire system)	Stores the results when cyclic transmission is started by System link start (SB0002). • 0: Normal • 1 or higher: Error definition in own station ( Page 177 Error Code List) When System link start (SB0002) is turned OFF, the stored error definition is cleared. (Conditions) This is enabled when the Baton pass status (own station) (SB0047) is OFF.	○	×
SW0053	Data link stop status (entire system)	Stores the results when cyclic transmission is stopped by System link stop (SB0003). • 0: Normal • 1 or higher: Error definition in own station ( Page 177 Error Code List) When System link stop (SB0003) is turned OFF, the stored error definition is cleared. (Conditions) This is enabled when the Baton pass status (own station) (SB0047) is OFF.	○	×
SW0054	Temporary error invalid station setting result	Stores the results when executing the temporary error invalid station setting. • 0: Normal • 1 or higher: Abnormal ( Page 177 Error Code List) When Temporary error invalid request (SB0010) is turned OFF, the stored error definition is cleared.	○	×
SW0055	Temporary error invalid station setting cancel result	Stores the results when canceling the temporary error invalid station setting. • 0: Normal • 1 or higher: Abnormal ( Page 177 Error Code List) When Temporary error invalid setting cancel request (SB0011) is turned OFF, the stored error definition is cleared.	○	×
SW0056	Result of reserved station function disable	Stores the result when disabling reserved station function. • 0: Normal • 1 or higher: Abnormal ( Page 177 Error Code List) When Reserved station function disable request (SB0012) is turned OFF, the stored error definition is cleared.	○	×
SW0057	Result of reserved station function enable	Stores the result when reserved station function disable is undone. • 0: Normal • 1 or higher: Abnormal ( Page 177 Error Code List) When Reserved station specification enable request (SB0013) is turned OFF, the stored error definition is cleared.	○	×
SW0058	Total number of linked stations (setting)	Stores the total number of linked stations (device stations) that are set by parameters. • Range: 1 to 120	○	○
SW0059	Total number of linked stations (current value)	Stores the total number of linked stations that are actually connected by data link in CC-Link IE Field Network. • Range: 1 to 120 (0 when own station is disconnected)	○	○
SW005A	Maximum baton pass station	Stores the maximum station number of the stations where the baton pass is performed. • Range: 1 to 120 (0 when own station is disconnected) (Conditions) This is enabled when the Baton pass status (own station) (SB0047) is OFF.	○	○
SW005B	Maximum cyclic transmission station	Stores the maximum station number of the station where the cyclic transmission is performed. • Range: 1 to 120 (0 when own station is disconnected) (Conditions) This is enabled when the Data link status (own station) (SB0049) is OFF.	○	○
SW0060	Maximum link scan time	Stores the maximum value of the link scan time during cyclic transmission. (Unit: ms) (Conditions) This is enabled when the Baton pass status (own station) (SB0047) is OFF.	○	○
SW0061	Minimum link scan time	Stores the minimum value of the link scan time during cyclic transmission. (Unit: ms) (Conditions) This is enabled when the Baton pass status (own station) (SB0047) is OFF.	○	○

Number	Name	Description	Availability	
			Master station	Local station
SW0062	Current link scan time	Stores the current value of the link scan time during cyclic transmission. The stored value contains a maximum error of 1 ms. (Unit: ms) (Conditions) This is enabled when the Baton pass status (own station) (SB0047) is OFF.	○	○
SW0063	Constant link scan set value	Stores the setting value of the contact link scan that is set in the supplementary setting. • 0: No setting • 1 to 200: Setting value of contact link scan time (Unit: ms) (Conditions) This is enabled when the Data link status (own station) (SB0049) is OFF.	○	○
SW0064	Connection status (own station)	Stores the connection status of own station. • 00H: Normal (communication in progress on PORT1 and PORT2) • 01H: Normal (communication in progress on PORT1, cable disconnected on PORT2) • 04H: Normal (loopback communication in progress on PORT1, cable disconnected on PORT2) • 10H: Normal (cable disconnected on PORT1, communication in progress on PORT2) • 11H: Disconnecting (cable disconnected on PORT1 and PORT2) • 12H: Disconnecting (cable disconnected on PORT1, establishing line on PORT2) • 21H: Disconnecting (establishing line on PORT1, cable disconnected on PORT2) • 22H: Disconnecting (establishing line on PORT1 and PORT2) • 40H: Normal (cable disconnected on PORT1, loopback communication in progress on PORT2)	○	○
SW0066	Actual link scan time (lower 1 word)	Stores the link scan time during cyclic transmission. (Unit: μs)	○	○
SW0067	Actual link scan time (upper 1 word)			
SW0068	PORT1 line error occurrence rate (max.)	Stores the occurrence rate (maximum value) of received error frames at the own station's PORT1. (Unit: %) When Clear communication error count (SB0006) is turned ON, the stored occurrence rate is cleared.	○	○
SW0069	PORT1 line error occurrence rate (present)	Stores the occurrence rate (current value) of received error frames at the own station's PORT1. (Unit: %) When Clear communication error count (SB0006) is turned ON, the stored occurrence rate is cleared.	○	○
SW006A	PORT2 line error occurrence rate (max.)	Stores the occurrence rate (maximum value) of received error frames at the own station's PORT2. (Unit: %) When Clear communication error count (SB0006) is turned ON, the stored occurrence rate is cleared.	○	○
SW006B	PORT2 line error occurrence rate (present)	Stores the occurrence rate (current value) of received error frames at the own station's PORT2. (Unit: %) When Clear communication error count (SB0006) is turned ON, the stored occurrence rate is cleared.	○	○
SW0070	Loopback station number 1	Stores the number of the station where loopback is being performed. The other loopback station number can be checked by Loopback station number 2 (SW0071). • 0: No loopback stations • 1 to 120: Device station • 125: Master station • 255: Station number not set If a station whose station number duplicates is performing loopback, this register stores the duplicated number. (Conditions) This is enabled when Baton pass status (own station) (SB0047) is OFF and Network configuration mismatch occurrence status (SB0098) is OFF.	○	×



Number	Name	Description	Availability	
			Master station	Local station
SW0071	Loopback station number 2	Stores the number of the station where loopback is being performed. The other loopback station number can be checked by Loopback station number 1 (SW0070). <ul style="list-style-type: none"> <li>• 0: No loopback stations</li> <li>• 1 to 120: Device station</li> <li>• 125: Master station</li> <li>• 255: Station number not set</li> </ul> If a station whose station number duplicates is performing loopback, this register stores the duplicated number. (Conditions) This is enabled when Baton pass status (own station) (SB0047) is OFF and Network configuration mismatch occurrence status (SB0098) is OFF.	○	×
SW0074	PORT1 cable disconnection detection count	Stores the (cumulative) count that was detected for cable disconnections at the PORT1. When Clear communication error count (SB0006) is turned ON, the stored count is cleared.	○	○
SW0075	PORT1 receive error detection count	Stores the (cumulative) count that error data was received at the PORT1. The count stores only error data that is not transmitted to all stations. When Clear communication error count (SB0006) is turned ON, the stored count is cleared. (Conditions) This is enabled when the Mode status (SW0043) is 0 or 1. (during online)	○	○
SW0076	PORT1 total number of received data (lower 1 word)	Stores the (cumulative) count that error data was received at the PORT1. When Clear communication error count (SB0006) is turned ON, the stored count is cleared. (Conditions) This is enabled when the Mode status (SW0043) is 0 or 1. (during online)	○	○
SW0077	PORT1 total number of received data (upper 1 word)			
SW007A	Event count	Stores the count of the network event history. This stored count is cleared when Event count clear (SB0009) is turned ON.	○	○
SW007C	PORT2 cable disconnection detection count	Stores the (cumulative) count that was detected for cable disconnections at the PORT2. When Clear communication error count (SB0006) is turned ON, the stored count is cleared.	○	×
SW007D	PORT2 receive error detection count	Stores the (cumulative) count that error data was received at the PORT2. The count stores only error data that is not transmitted to all stations. When Clear communication error count (SB0006) is turned ON, the stored count is cleared. (Conditions) This is enabled when the Mode status (SW0043) is 0 or 1. (during online)	○	×
SW007E	PORT2 total number of received data (lower 1 word)	Stores the (cumulative) count that error data was received at the PORT2. When Clear communication error count (SB0006) is turned ON, the stored count is cleared. (Conditions) This is enabled when the Mode status (SW0043) is 0 or 1. (during online)	○	×
SW007F	PORT2 total number of received data (upper 1 word)			
SW0080 to SW009F	Execution status (REMF/REMTO)	Stores the REMFR/REMTO execution status for each channel.  SW0080 Channel 1    SW008B Channel 12    SW0096 Channel 23 SW0081 Channel 2    SW008C Channel 13    SW0097 Channel 24 SW0082 Channel 3    SW008D Channel 14    SW0098 Channel 25 SW0083 Channel 4    SW008E Channel 15    SW0099 Channel 26 SW0084 Channel 5    SW008F Channel 16    SW009A Channel 27 SW0085 Channel 6    SW0090 Channel 17    SW009B Channel 28 SW0086 Channel 7    SW0091 Channel 18    SW009C Channel 29 SW0087 Channel 8    SW0092 Channel 19    SW009D Channel 30 SW0088 Channel 9    SW0093 Channel 20    SW009E Channel 31 SW0089 Channel 10    SW0094 Channel 21    SW009F Channel 32 SW008A Channel 11    SW0095 Channel 22  <ul style="list-style-type: none"> <li>• 0: Normal completion</li> <li>• 1 or higher: Abnormal completion (☞ Page 177 Error Code List)</li> </ul>	○	○

Number	Name	Description	Availability																																																																																																																																																										
			Master station	Local station																																																																																																																																																									
SW00A0 to SW00A7	Baton pass status (each station)	<p>Stores the baton pass status for each station.</p> <ul style="list-style-type: none"> <li>• 0: Baton pass normal station</li> <li>• 1: Baton pass faulty station</li> </ul> <p>If multiple stations change from faulty to normal, because they are reconnected to the network one by one per link scan, the time until the status changes to "0: Baton pass normal station" may vary by several seconds.</p> <ul style="list-style-type: none"> <li>• If cables are connected/disconnected or the module is reset in line and ring topologies, the token may be lost or a reconstruction may occur, causing the baton pass status to detect an error in the first link scan.</li> </ul> <table border="1"> <thead> <tr> <th></th> <th>b15</th> <th>b14</th> <th>b13</th> <th>b12</th> <th>b11</th> <th>b10</th> <th>b9</th> <th>b8</th> <th>b7</th> <th>b6</th> <th>b5</th> <th>b4</th> <th>b3</th> <th>b2</th> <th>b1</th> <th>b0</th> </tr> </thead> <tbody> <tr> <td>SW00A0</td> <td>16</td> <td>15</td> <td>14</td> <td>13</td> <td>12</td> <td>11</td> <td>10</td> <td>9</td> <td>8</td> <td>7</td> <td>6</td> <td>5</td> <td>4</td> <td>3</td> <td>2</td> <td>1</td> </tr> <tr> <td>SW00A1</td> <td>32</td> <td>31</td> <td>30</td> <td>29</td> <td>28</td> <td>27</td> <td>26</td> <td>25</td> <td>24</td> <td>23</td> <td>22</td> <td>21</td> <td>20</td> <td>19</td> <td>18</td> <td>17</td> </tr> <tr> <td>SW00A2</td> <td>48</td> <td>47</td> <td>46</td> <td>45</td> <td>44</td> <td>43</td> <td>42</td> <td>41</td> <td>40</td> <td>39</td> <td>38</td> <td>37</td> <td>36</td> <td>35</td> <td>34</td> <td>33</td> </tr> <tr> <td>SW00A3</td> <td>64</td> <td>63</td> <td>62</td> <td>61</td> <td>60</td> <td>59</td> <td>58</td> <td>57</td> <td>56</td> <td>55</td> <td>54</td> <td>53</td> <td>52</td> <td>51</td> <td>50</td> <td>49</td> </tr> <tr> <td>SW00A4</td> <td>80</td> <td>79</td> <td>78</td> <td>77</td> <td>76</td> <td>75</td> <td>74</td> <td>73</td> <td>72</td> <td>71</td> <td>70</td> <td>69</td> <td>68</td> <td>67</td> <td>66</td> <td>65</td> </tr> <tr> <td>SW00A5</td> <td>96</td> <td>95</td> <td>94</td> <td>93</td> <td>92</td> <td>91</td> <td>90</td> <td>89</td> <td>88</td> <td>87</td> <td>86</td> <td>85</td> <td>84</td> <td>83</td> <td>82</td> <td>81</td> </tr> <tr> <td>SW00A6</td> <td>112</td> <td>111</td> <td>110</td> <td>109</td> <td>108</td> <td>107</td> <td>106</td> <td>105</td> <td>104</td> <td>103</td> <td>102</td> <td>101</td> <td>100</td> <td>99</td> <td>98</td> <td>97</td> </tr> <tr> <td>SW00A7</td> <td>—</td> <td>—</td> <td>—</td> <td>—</td> <td>—</td> <td>—</td> <td>—</td> <td>—</td> <td>120</td> <td>119</td> <td>118</td> <td>117</td> <td>116</td> <td>115</td> <td>114</td> <td>113</td> </tr> </tbody> </table> <p>Each number in the table represents a station No. — is fixed to 0.</p> <p>(Conditions)</p> <ul style="list-style-type: none"> <li>• This is enabled when the Baton pass status (own station) (SB0047) is OFF.</li> <li>• Reserved stations and stations higher than the maximum station number are ignored.</li> </ul>		b15	b14	b13	b12	b11	b10	b9	b8	b7	b6	b5	b4	b3	b2	b1	b0	SW00A0	16	15	14	13	12	11	10	9	8	7	6	5	4	3	2	1	SW00A1	32	31	30	29	28	27	26	25	24	23	22	21	20	19	18	17	SW00A2	48	47	46	45	44	43	42	41	40	39	38	37	36	35	34	33	SW00A3	64	63	62	61	60	59	58	57	56	55	54	53	52	51	50	49	SW00A4	80	79	78	77	76	75	74	73	72	71	70	69	68	67	66	65	SW00A5	96	95	94	93	92	91	90	89	88	87	86	85	84	83	82	81	SW00A6	112	111	110	109	108	107	106	105	104	103	102	101	100	99	98	97	SW00A7	—	—	—	—	—	—	—	—	120	119	118	117	116	115	114	113	<input type="radio"/>	<input type="radio"/>
	b15	b14	b13	b12	b11	b10	b9	b8	b7	b6	b5	b4	b3	b2	b1	b0																																																																																																																																													
SW00A0	16	15	14	13	12	11	10	9	8	7	6	5	4	3	2	1																																																																																																																																													
SW00A1	32	31	30	29	28	27	26	25	24	23	22	21	20	19	18	17																																																																																																																																													
SW00A2	48	47	46	45	44	43	42	41	40	39	38	37	36	35	34	33																																																																																																																																													
SW00A3	64	63	62	61	60	59	58	57	56	55	54	53	52	51	50	49																																																																																																																																													
SW00A4	80	79	78	77	76	75	74	73	72	71	70	69	68	67	66	65																																																																																																																																													
SW00A5	96	95	94	93	92	91	90	89	88	87	86	85	84	83	82	81																																																																																																																																													
SW00A6	112	111	110	109	108	107	106	105	104	103	102	101	100	99	98	97																																																																																																																																													
SW00A7	—	—	—	—	—	—	—	—	120	119	118	117	116	115	114	113																																																																																																																																													
SW00B0 to SW00B7	Data link status (each station)	<p>Stores the cyclic transmission status for each station.</p> <ul style="list-style-type: none"> <li>• 0: Cyclic transmission normal station</li> <li>• 1: Cyclic transmission faulty station</li> </ul> <p>If multiple stations change from faulty to normal, because they are reconnected to the network one by one per link scan, the time until the status changes to "0: Cyclic transmission normal station" may vary by several seconds.</p> <p>If no response is received for several link scans, the station is determined to be a cyclic transmission faulty station.</p> <table border="1"> <thead> <tr> <th></th> <th>b15</th> <th>b14</th> <th>b13</th> <th>b12</th> <th>b11</th> <th>b10</th> <th>b9</th> <th>b8</th> <th>b7</th> <th>b6</th> <th>b5</th> <th>b4</th> <th>b3</th> <th>b2</th> <th>b1</th> <th>b0</th> </tr> </thead> <tbody> <tr> <td>SW00B0</td> <td>16</td> <td>15</td> <td>14</td> <td>13</td> <td>12</td> <td>11</td> <td>10</td> <td>9</td> <td>8</td> <td>7</td> <td>6</td> <td>5</td> <td>4</td> <td>3</td> <td>2</td> <td>1</td> </tr> <tr> <td>SW00B1</td> <td>32</td> <td>31</td> <td>30</td> <td>29</td> <td>28</td> <td>27</td> <td>26</td> <td>25</td> <td>24</td> <td>23</td> <td>22</td> <td>21</td> <td>20</td> <td>19</td> <td>18</td> <td>17</td> </tr> <tr> <td>SW00B2</td> <td>48</td> <td>47</td> <td>46</td> <td>45</td> <td>44</td> <td>43</td> <td>42</td> <td>41</td> <td>40</td> <td>39</td> <td>38</td> <td>37</td> <td>36</td> <td>35</td> <td>34</td> <td>33</td> </tr> <tr> <td>SW00B3</td> <td>64</td> <td>63</td> <td>62</td> <td>61</td> <td>60</td> <td>59</td> <td>58</td> <td>57</td> <td>56</td> <td>55</td> <td>54</td> <td>53</td> <td>52</td> <td>51</td> <td>50</td> <td>49</td> </tr> <tr> <td>SW00B4</td> <td>80</td> <td>79</td> <td>78</td> <td>77</td> <td>76</td> <td>75</td> <td>74</td> <td>73</td> <td>72</td> <td>71</td> <td>70</td> <td>69</td> <td>68</td> <td>67</td> <td>66</td> <td>65</td> </tr> <tr> <td>SW00B5</td> <td>96</td> <td>95</td> <td>94</td> <td>93</td> <td>92</td> <td>91</td> <td>90</td> <td>89</td> <td>88</td> <td>87</td> <td>86</td> <td>85</td> <td>84</td> <td>83</td> <td>82</td> <td>81</td> </tr> <tr> <td>SW00B6</td> <td>112</td> <td>111</td> <td>110</td> <td>109</td> <td>108</td> <td>107</td> <td>106</td> <td>105</td> <td>104</td> <td>103</td> <td>102</td> <td>101</td> <td>100</td> <td>99</td> <td>98</td> <td>97</td> </tr> <tr> <td>SW00B7</td> <td>—</td> <td>—</td> <td>—</td> <td>—</td> <td>—</td> <td>—</td> <td>—</td> <td>—</td> <td>120</td> <td>119</td> <td>118</td> <td>117</td> <td>116</td> <td>115</td> <td>114</td> <td>113</td> </tr> </tbody> </table> <p>Each number in the table represents a station No. — is fixed to 0.</p> <p>(Conditions)</p> <ul style="list-style-type: none"> <li>• This is enabled when the Baton pass status (own station) (SB0047) is OFF.</li> <li>• Stations higher than the maximum station number are ignored.</li> </ul>		b15	b14	b13	b12	b11	b10	b9	b8	b7	b6	b5	b4	b3	b2	b1	b0	SW00B0	16	15	14	13	12	11	10	9	8	7	6	5	4	3	2	1	SW00B1	32	31	30	29	28	27	26	25	24	23	22	21	20	19	18	17	SW00B2	48	47	46	45	44	43	42	41	40	39	38	37	36	35	34	33	SW00B3	64	63	62	61	60	59	58	57	56	55	54	53	52	51	50	49	SW00B4	80	79	78	77	76	75	74	73	72	71	70	69	68	67	66	65	SW00B5	96	95	94	93	92	91	90	89	88	87	86	85	84	83	82	81	SW00B6	112	111	110	109	108	107	106	105	104	103	102	101	100	99	98	97	SW00B7	—	—	—	—	—	—	—	—	120	119	118	117	116	115	114	113	<input type="radio"/>	<input type="radio"/>
	b15	b14	b13	b12	b11	b10	b9	b8	b7	b6	b5	b4	b3	b2	b1	b0																																																																																																																																													
SW00B0	16	15	14	13	12	11	10	9	8	7	6	5	4	3	2	1																																																																																																																																													
SW00B1	32	31	30	29	28	27	26	25	24	23	22	21	20	19	18	17																																																																																																																																													
SW00B2	48	47	46	45	44	43	42	41	40	39	38	37	36	35	34	33																																																																																																																																													
SW00B3	64	63	62	61	60	59	58	57	56	55	54	53	52	51	50	49																																																																																																																																													
SW00B4	80	79	78	77	76	75	74	73	72	71	70	69	68	67	66	65																																																																																																																																													
SW00B5	96	95	94	93	92	91	90	89	88	87	86	85	84	83	82	81																																																																																																																																													
SW00B6	112	111	110	109	108	107	106	105	104	103	102	101	100	99	98	97																																																																																																																																													
SW00B7	—	—	—	—	—	—	—	—	120	119	118	117	116	115	114	113																																																																																																																																													



Number	Name	Description	Availability																																																																																																																																																										
			Master station	Local station																																																																																																																																																									
SW00B8 to SW00BF	Network connection status	<p>Stores the connection status to the network.</p> <ul style="list-style-type: none"> <li>• 0: Station not connected to the network</li> <li>• 1: Station connected to the network</li> </ul> <table border="1"> <thead> <tr> <th></th> <th>b15</th> <th>b14</th> <th>b13</th> <th>b12</th> <th>b11</th> <th>b10</th> <th>b9</th> <th>b8</th> <th>b7</th> <th>b6</th> <th>b5</th> <th>b4</th> <th>b3</th> <th>b2</th> <th>b1</th> <th>b0</th> </tr> </thead> <tbody> <tr> <td>SW00B8</td> <td>16</td> <td>15</td> <td>14</td> <td>13</td> <td>12</td> <td>11</td> <td>10</td> <td>9</td> <td>8</td> <td>7</td> <td>6</td> <td>5</td> <td>4</td> <td>3</td> <td>2</td> <td>1</td> </tr> <tr> <td>SW00B9</td> <td>32</td> <td>31</td> <td>30</td> <td>29</td> <td>28</td> <td>27</td> <td>26</td> <td>25</td> <td>24</td> <td>23</td> <td>22</td> <td>21</td> <td>20</td> <td>19</td> <td>18</td> <td>17</td> </tr> <tr> <td>SW00BA</td> <td>48</td> <td>47</td> <td>46</td> <td>45</td> <td>44</td> <td>43</td> <td>42</td> <td>41</td> <td>40</td> <td>39</td> <td>38</td> <td>37</td> <td>36</td> <td>35</td> <td>34</td> <td>33</td> </tr> <tr> <td>SW00BB</td> <td>64</td> <td>63</td> <td>62</td> <td>61</td> <td>60</td> <td>59</td> <td>58</td> <td>57</td> <td>56</td> <td>55</td> <td>54</td> <td>53</td> <td>52</td> <td>51</td> <td>50</td> <td>49</td> </tr> <tr> <td>SW00BC</td> <td>80</td> <td>79</td> <td>78</td> <td>77</td> <td>76</td> <td>75</td> <td>74</td> <td>73</td> <td>72</td> <td>71</td> <td>70</td> <td>69</td> <td>68</td> <td>67</td> <td>66</td> <td>65</td> </tr> <tr> <td>SW00BD</td> <td>96</td> <td>95</td> <td>94</td> <td>93</td> <td>92</td> <td>91</td> <td>90</td> <td>89</td> <td>88</td> <td>87</td> <td>86</td> <td>85</td> <td>84</td> <td>83</td> <td>82</td> <td>81</td> </tr> <tr> <td>SW00BE</td> <td>112</td> <td>111</td> <td>110</td> <td>109</td> <td>108</td> <td>107</td> <td>106</td> <td>105</td> <td>104</td> <td>103</td> <td>102</td> <td>101</td> <td>100</td> <td>99</td> <td>98</td> <td>97</td> </tr> <tr> <td>SW00BF</td> <td>—</td> <td>—</td> <td>—</td> <td>—</td> <td>—</td> <td>—</td> <td>—</td> <td>—</td> <td>120</td> <td>119</td> <td>118</td> <td>117</td> <td>116</td> <td>115</td> <td>114</td> <td>113</td> </tr> </tbody> </table> <p>Each number in the table represents a station No. — is fixed to 0.</p> <p>(Conditions)</p> <ul style="list-style-type: none"> <li>• This is not affected by Baton pass status (each station) (SW00A0 to SW00A7) and Data link status (each station) (SB00B0, SW00B0 to SW00B7).</li> <li>• This is enabled only for the station which has same network number as that of the master operating station.</li> </ul>		b15	b14	b13	b12	b11	b10	b9	b8	b7	b6	b5	b4	b3	b2	b1	b0	SW00B8	16	15	14	13	12	11	10	9	8	7	6	5	4	3	2	1	SW00B9	32	31	30	29	28	27	26	25	24	23	22	21	20	19	18	17	SW00BA	48	47	46	45	44	43	42	41	40	39	38	37	36	35	34	33	SW00BB	64	63	62	61	60	59	58	57	56	55	54	53	52	51	50	49	SW00BC	80	79	78	77	76	75	74	73	72	71	70	69	68	67	66	65	SW00BD	96	95	94	93	92	91	90	89	88	87	86	85	84	83	82	81	SW00BE	112	111	110	109	108	107	106	105	104	103	102	101	100	99	98	97	SW00BF	—	—	—	—	—	—	—	—	120	119	118	117	116	115	114	113	○	○
	b15	b14	b13	b12	b11	b10	b9	b8	b7	b6	b5	b4	b3	b2	b1	b0																																																																																																																																													
SW00B8	16	15	14	13	12	11	10	9	8	7	6	5	4	3	2	1																																																																																																																																													
SW00B9	32	31	30	29	28	27	26	25	24	23	22	21	20	19	18	17																																																																																																																																													
SW00BA	48	47	46	45	44	43	42	41	40	39	38	37	36	35	34	33																																																																																																																																													
SW00BB	64	63	62	61	60	59	58	57	56	55	54	53	52	51	50	49																																																																																																																																													
SW00BC	80	79	78	77	76	75	74	73	72	71	70	69	68	67	66	65																																																																																																																																													
SW00BD	96	95	94	93	92	91	90	89	88	87	86	85	84	83	82	81																																																																																																																																													
SW00BE	112	111	110	109	108	107	106	105	104	103	102	101	100	99	98	97																																																																																																																																													
SW00BF	—	—	—	—	—	—	—	—	120	119	118	117	116	115	114	113																																																																																																																																													
SW00C0 to SW00C7	Reserved station specification	<p>Stores the setting status of the reserved station.</p> <ul style="list-style-type: none"> <li>• 0: Other than reserved station (also includes stations specified as reserved station disable status)</li> <li>• 1: Reserved station</li> </ul> <table border="1"> <thead> <tr> <th></th> <th>b15</th> <th>b14</th> <th>b13</th> <th>b12</th> <th>b11</th> <th>b10</th> <th>b9</th> <th>b8</th> <th>b7</th> <th>b6</th> <th>b5</th> <th>b4</th> <th>b3</th> <th>b2</th> <th>b1</th> <th>b0</th> </tr> </thead> <tbody> <tr> <td>SW00C0</td> <td>16</td> <td>15</td> <td>14</td> <td>13</td> <td>12</td> <td>11</td> <td>10</td> <td>9</td> <td>8</td> <td>7</td> <td>6</td> <td>5</td> <td>4</td> <td>3</td> <td>2</td> <td>1</td> </tr> <tr> <td>SW00C1</td> <td>32</td> <td>31</td> <td>30</td> <td>29</td> <td>28</td> <td>27</td> <td>26</td> <td>25</td> <td>24</td> <td>23</td> <td>22</td> <td>21</td> <td>20</td> <td>19</td> <td>18</td> <td>17</td> </tr> <tr> <td>SW00C2</td> <td>48</td> <td>47</td> <td>46</td> <td>45</td> <td>44</td> <td>43</td> <td>42</td> <td>41</td> <td>40</td> <td>39</td> <td>38</td> <td>37</td> <td>36</td> <td>35</td> <td>34</td> <td>33</td> </tr> <tr> <td>SW00C3</td> <td>64</td> <td>63</td> <td>62</td> <td>61</td> <td>60</td> <td>59</td> <td>58</td> <td>57</td> <td>56</td> <td>55</td> <td>54</td> <td>53</td> <td>52</td> <td>51</td> <td>50</td> <td>49</td> </tr> <tr> <td>SW00C4</td> <td>80</td> <td>79</td> <td>78</td> <td>77</td> <td>76</td> <td>75</td> <td>74</td> <td>73</td> <td>72</td> <td>71</td> <td>70</td> <td>69</td> <td>68</td> <td>67</td> <td>66</td> <td>65</td> </tr> <tr> <td>SW00C5</td> <td>96</td> <td>95</td> <td>94</td> <td>93</td> <td>92</td> <td>91</td> <td>90</td> <td>89</td> <td>88</td> <td>87</td> <td>86</td> <td>85</td> <td>84</td> <td>83</td> <td>82</td> <td>81</td> </tr> <tr> <td>SW00C6</td> <td>112</td> <td>111</td> <td>110</td> <td>109</td> <td>108</td> <td>107</td> <td>106</td> <td>105</td> <td>104</td> <td>103</td> <td>102</td> <td>101</td> <td>100</td> <td>99</td> <td>98</td> <td>97</td> </tr> <tr> <td>SW00C7</td> <td>—</td> <td>—</td> <td>—</td> <td>—</td> <td>—</td> <td>—</td> <td>—</td> <td>—</td> <td>120</td> <td>119</td> <td>118</td> <td>117</td> <td>116</td> <td>115</td> <td>114</td> <td>113</td> </tr> </tbody> </table> <p>Each number in the table represents a station No. — is fixed to 0.</p> <p>(Conditions)</p> <ul style="list-style-type: none"> <li>• This is enabled when the Baton pass status (own station) (SB0047) is OFF.</li> <li>• Holds the data immediately before the error.</li> <li>• This is enabled only for normal stations in the Baton pass status (each station) (SW00A0 to SW00A7).</li> <li>• Stations higher than the maximum station number are ignored.</li> </ul>		b15	b14	b13	b12	b11	b10	b9	b8	b7	b6	b5	b4	b3	b2	b1	b0	SW00C0	16	15	14	13	12	11	10	9	8	7	6	5	4	3	2	1	SW00C1	32	31	30	29	28	27	26	25	24	23	22	21	20	19	18	17	SW00C2	48	47	46	45	44	43	42	41	40	39	38	37	36	35	34	33	SW00C3	64	63	62	61	60	59	58	57	56	55	54	53	52	51	50	49	SW00C4	80	79	78	77	76	75	74	73	72	71	70	69	68	67	66	65	SW00C5	96	95	94	93	92	91	90	89	88	87	86	85	84	83	82	81	SW00C6	112	111	110	109	108	107	106	105	104	103	102	101	100	99	98	97	SW00C7	—	—	—	—	—	—	—	—	120	119	118	117	116	115	114	113	○	○
	b15	b14	b13	b12	b11	b10	b9	b8	b7	b6	b5	b4	b3	b2	b1	b0																																																																																																																																													
SW00C0	16	15	14	13	12	11	10	9	8	7	6	5	4	3	2	1																																																																																																																																													
SW00C1	32	31	30	29	28	27	26	25	24	23	22	21	20	19	18	17																																																																																																																																													
SW00C2	48	47	46	45	44	43	42	41	40	39	38	37	36	35	34	33																																																																																																																																													
SW00C3	64	63	62	61	60	59	58	57	56	55	54	53	52	51	50	49																																																																																																																																													
SW00C4	80	79	78	77	76	75	74	73	72	71	70	69	68	67	66	65																																																																																																																																													
SW00C5	96	95	94	93	92	91	90	89	88	87	86	85	84	83	82	81																																																																																																																																													
SW00C6	112	111	110	109	108	107	106	105	104	103	102	101	100	99	98	97																																																																																																																																													
SW00C7	—	—	—	—	—	—	—	—	120	119	118	117	116	115	114	113																																																																																																																																													
SW00C8 to SW00CF	Parameter setting status	<p>Stores the parameter setting status.</p> <ul style="list-style-type: none"> <li>• 0: Station not set in the parameter</li> <li>• 1: Station set in the parameter</li> </ul> <table border="1"> <thead> <tr> <th></th> <th>b15</th> <th>b14</th> <th>b13</th> <th>b12</th> <th>b11</th> <th>b10</th> <th>b9</th> <th>b8</th> <th>b7</th> <th>b6</th> <th>b5</th> <th>b4</th> <th>b3</th> <th>b2</th> <th>b1</th> <th>b0</th> </tr> </thead> <tbody> <tr> <td>SW00C8</td> <td>16</td> <td>15</td> <td>14</td> <td>13</td> <td>12</td> <td>11</td> <td>10</td> <td>9</td> <td>8</td> <td>7</td> <td>6</td> <td>5</td> <td>4</td> <td>3</td> <td>2</td> <td>1</td> </tr> <tr> <td>SW00C9</td> <td>32</td> <td>31</td> <td>30</td> <td>29</td> <td>28</td> <td>27</td> <td>26</td> <td>25</td> <td>24</td> <td>23</td> <td>22</td> <td>21</td> <td>20</td> <td>19</td> <td>18</td> <td>17</td> </tr> <tr> <td>SW00CA</td> <td>48</td> <td>47</td> <td>46</td> <td>45</td> <td>44</td> <td>43</td> <td>42</td> <td>41</td> <td>40</td> <td>39</td> <td>38</td> <td>37</td> <td>36</td> <td>35</td> <td>34</td> <td>33</td> </tr> <tr> <td>SW00CB</td> <td>64</td> <td>63</td> <td>62</td> <td>61</td> <td>60</td> <td>59</td> <td>58</td> <td>57</td> <td>56</td> <td>55</td> <td>54</td> <td>53</td> <td>52</td> <td>51</td> <td>50</td> <td>49</td> </tr> <tr> <td>SW00CC</td> <td>80</td> <td>79</td> <td>78</td> <td>77</td> <td>76</td> <td>75</td> <td>74</td> <td>73</td> <td>72</td> <td>71</td> <td>70</td> <td>69</td> <td>68</td> <td>67</td> <td>66</td> <td>65</td> </tr> <tr> <td>SW00CD</td> <td>96</td> <td>95</td> <td>94</td> <td>93</td> <td>92</td> <td>91</td> <td>90</td> <td>89</td> <td>88</td> <td>87</td> <td>86</td> <td>85</td> <td>84</td> <td>83</td> <td>82</td> <td>81</td> </tr> <tr> <td>SW00CE</td> <td>112</td> <td>111</td> <td>110</td> <td>109</td> <td>108</td> <td>107</td> <td>106</td> <td>105</td> <td>104</td> <td>103</td> <td>102</td> <td>101</td> <td>100</td> <td>99</td> <td>98</td> <td>97</td> </tr> <tr> <td>SW00CF</td> <td>—</td> <td>—</td> <td>—</td> <td>—</td> <td>—</td> <td>—</td> <td>—</td> <td>—</td> <td>120</td> <td>119</td> <td>118</td> <td>117</td> <td>116</td> <td>115</td> <td>114</td> <td>113</td> </tr> </tbody> </table> <p>Each number in the table represents a station No. — is fixed to 0.</p> <p>(Conditions)</p> <ul style="list-style-type: none"> <li>• This is enabled when the Baton pass status (own station) (SB0047) is OFF.</li> </ul>		b15	b14	b13	b12	b11	b10	b9	b8	b7	b6	b5	b4	b3	b2	b1	b0	SW00C8	16	15	14	13	12	11	10	9	8	7	6	5	4	3	2	1	SW00C9	32	31	30	29	28	27	26	25	24	23	22	21	20	19	18	17	SW00CA	48	47	46	45	44	43	42	41	40	39	38	37	36	35	34	33	SW00CB	64	63	62	61	60	59	58	57	56	55	54	53	52	51	50	49	SW00CC	80	79	78	77	76	75	74	73	72	71	70	69	68	67	66	65	SW00CD	96	95	94	93	92	91	90	89	88	87	86	85	84	83	82	81	SW00CE	112	111	110	109	108	107	106	105	104	103	102	101	100	99	98	97	SW00CF	—	—	—	—	—	—	—	—	120	119	118	117	116	115	114	113	○	○
	b15	b14	b13	b12	b11	b10	b9	b8	b7	b6	b5	b4	b3	b2	b1	b0																																																																																																																																													
SW00C8	16	15	14	13	12	11	10	9	8	7	6	5	4	3	2	1																																																																																																																																													
SW00C9	32	31	30	29	28	27	26	25	24	23	22	21	20	19	18	17																																																																																																																																													
SW00CA	48	47	46	45	44	43	42	41	40	39	38	37	36	35	34	33																																																																																																																																													
SW00CB	64	63	62	61	60	59	58	57	56	55	54	53	52	51	50	49																																																																																																																																													
SW00CC	80	79	78	77	76	75	74	73	72	71	70	69	68	67	66	65																																																																																																																																													
SW00CD	96	95	94	93	92	91	90	89	88	87	86	85	84	83	82	81																																																																																																																																													
SW00CE	112	111	110	109	108	107	106	105	104	103	102	101	100	99	98	97																																																																																																																																													
SW00CF	—	—	—	—	—	—	—	—	120	119	118	117	116	115	114	113																																																																																																																																													

Number	Name	Description	Availability																																																																																																																																																										
			Master station	Local station																																																																																																																																																									
SW00D0 to SW00D7	Error invalid station setting	<p>Stores the setting status of error invalid stations.</p> <ul style="list-style-type: none"> <li>• 0: Other than error invalid station</li> <li>• 1: Error invalid station</li> </ul> <table border="1"> <thead> <tr> <th></th> <th>b15</th><th>b14</th><th>b13</th><th>b12</th><th>b11</th><th>b10</th><th>b9</th><th>b8</th><th>b7</th><th>b6</th><th>b5</th><th>b4</th><th>b3</th><th>b2</th><th>b1</th><th>b0</th> </tr> </thead> <tbody> <tr><td>SW00D0</td><td>16</td><td>15</td><td>14</td><td>13</td><td>12</td><td>11</td><td>10</td><td>9</td><td>8</td><td>7</td><td>6</td><td>5</td><td>4</td><td>3</td><td>2</td><td>1</td></tr> <tr><td>SW00D1</td><td>32</td><td>31</td><td>30</td><td>29</td><td>28</td><td>27</td><td>26</td><td>25</td><td>24</td><td>23</td><td>22</td><td>21</td><td>20</td><td>19</td><td>18</td><td>17</td></tr> <tr><td>SW00D2</td><td>48</td><td>47</td><td>46</td><td>45</td><td>44</td><td>43</td><td>42</td><td>41</td><td>40</td><td>39</td><td>38</td><td>37</td><td>36</td><td>35</td><td>34</td><td>33</td></tr> <tr><td>SW00D3</td><td>64</td><td>63</td><td>62</td><td>61</td><td>60</td><td>59</td><td>58</td><td>57</td><td>56</td><td>55</td><td>54</td><td>53</td><td>52</td><td>51</td><td>50</td><td>49</td></tr> <tr><td>SW00D4</td><td>80</td><td>79</td><td>78</td><td>77</td><td>76</td><td>75</td><td>74</td><td>73</td><td>72</td><td>71</td><td>70</td><td>69</td><td>68</td><td>67</td><td>66</td><td>65</td></tr> <tr><td>SW00D5</td><td>96</td><td>95</td><td>94</td><td>93</td><td>92</td><td>91</td><td>90</td><td>89</td><td>88</td><td>87</td><td>86</td><td>85</td><td>84</td><td>83</td><td>82</td><td>81</td></tr> <tr><td>SW00D6</td><td>112</td><td>111</td><td>110</td><td>109</td><td>108</td><td>107</td><td>106</td><td>105</td><td>104</td><td>103</td><td>102</td><td>101</td><td>100</td><td>99</td><td>98</td><td>97</td></tr> <tr><td>SW00D7</td><td>—</td><td>—</td><td>—</td><td>—</td><td>—</td><td>—</td><td>—</td><td>—</td><td>120</td><td>119</td><td>118</td><td>117</td><td>116</td><td>115</td><td>114</td><td>113</td></tr> </tbody> </table> <p>Each number in the table represents a station No. — is fixed to 0.</p> <p>(Conditions)</p> <ul style="list-style-type: none"> <li>• This is enabled when the Baton pass status (own station) (SB0047) is OFF.</li> <li>• Stations higher than the maximum station number are ignored.</li> </ul>		b15	b14	b13	b12	b11	b10	b9	b8	b7	b6	b5	b4	b3	b2	b1	b0	SW00D0	16	15	14	13	12	11	10	9	8	7	6	5	4	3	2	1	SW00D1	32	31	30	29	28	27	26	25	24	23	22	21	20	19	18	17	SW00D2	48	47	46	45	44	43	42	41	40	39	38	37	36	35	34	33	SW00D3	64	63	62	61	60	59	58	57	56	55	54	53	52	51	50	49	SW00D4	80	79	78	77	76	75	74	73	72	71	70	69	68	67	66	65	SW00D5	96	95	94	93	92	91	90	89	88	87	86	85	84	83	82	81	SW00D6	112	111	110	109	108	107	106	105	104	103	102	101	100	99	98	97	SW00D7	—	—	—	—	—	—	—	—	120	119	118	117	116	115	114	113	<input type="radio"/>	<input type="radio"/>
	b15	b14	b13	b12	b11	b10	b9	b8	b7	b6	b5	b4	b3	b2	b1	b0																																																																																																																																													
SW00D0	16	15	14	13	12	11	10	9	8	7	6	5	4	3	2	1																																																																																																																																													
SW00D1	32	31	30	29	28	27	26	25	24	23	22	21	20	19	18	17																																																																																																																																													
SW00D2	48	47	46	45	44	43	42	41	40	39	38	37	36	35	34	33																																																																																																																																													
SW00D3	64	63	62	61	60	59	58	57	56	55	54	53	52	51	50	49																																																																																																																																													
SW00D4	80	79	78	77	76	75	74	73	72	71	70	69	68	67	66	65																																																																																																																																													
SW00D5	96	95	94	93	92	91	90	89	88	87	86	85	84	83	82	81																																																																																																																																													
SW00D6	112	111	110	109	108	107	106	105	104	103	102	101	100	99	98	97																																																																																																																																													
SW00D7	—	—	—	—	—	—	—	—	120	119	118	117	116	115	114	113																																																																																																																																													
SW00E0 to SW00E7	Temporary error invalid station setting	<p>Stores the setting status of the temporary error invalid station.</p> <ul style="list-style-type: none"> <li>• 0: Other than temporary error invalid station</li> <li>• 1: Temporary error invalid station</li> </ul> <table border="1"> <thead> <tr> <th></th> <th>b15</th><th>b14</th><th>b13</th><th>b12</th><th>b11</th><th>b10</th><th>b9</th><th>b8</th><th>b7</th><th>b6</th><th>b5</th><th>b4</th><th>b3</th><th>b2</th><th>b1</th><th>b0</th> </tr> </thead> <tbody> <tr><td>SW00E0</td><td>16</td><td>15</td><td>14</td><td>13</td><td>12</td><td>11</td><td>10</td><td>9</td><td>8</td><td>7</td><td>6</td><td>5</td><td>4</td><td>3</td><td>2</td><td>1</td></tr> <tr><td>SW00E1</td><td>32</td><td>31</td><td>30</td><td>29</td><td>28</td><td>27</td><td>26</td><td>25</td><td>24</td><td>23</td><td>22</td><td>21</td><td>20</td><td>19</td><td>18</td><td>17</td></tr> <tr><td>SW00E2</td><td>48</td><td>47</td><td>46</td><td>45</td><td>44</td><td>43</td><td>42</td><td>41</td><td>40</td><td>39</td><td>38</td><td>37</td><td>36</td><td>35</td><td>34</td><td>33</td></tr> <tr><td>SW00E3</td><td>64</td><td>63</td><td>62</td><td>61</td><td>60</td><td>59</td><td>58</td><td>57</td><td>56</td><td>55</td><td>54</td><td>53</td><td>52</td><td>51</td><td>50</td><td>49</td></tr> <tr><td>SW00E4</td><td>80</td><td>79</td><td>78</td><td>77</td><td>76</td><td>75</td><td>74</td><td>73</td><td>72</td><td>71</td><td>70</td><td>69</td><td>68</td><td>67</td><td>66</td><td>65</td></tr> <tr><td>SW00E5</td><td>96</td><td>95</td><td>94</td><td>93</td><td>92</td><td>91</td><td>90</td><td>89</td><td>88</td><td>87</td><td>86</td><td>85</td><td>84</td><td>83</td><td>82</td><td>81</td></tr> <tr><td>SW00E6</td><td>112</td><td>111</td><td>110</td><td>109</td><td>108</td><td>107</td><td>106</td><td>105</td><td>104</td><td>103</td><td>102</td><td>101</td><td>100</td><td>99</td><td>98</td><td>97</td></tr> <tr><td>SW00E7</td><td>—</td><td>—</td><td>—</td><td>—</td><td>—</td><td>—</td><td>—</td><td>—</td><td>120</td><td>119</td><td>118</td><td>117</td><td>116</td><td>115</td><td>114</td><td>113</td></tr> </tbody> </table> <p>Each number in the table represents a station No. — is fixed to 0.</p> <p>(Conditions)</p> <ul style="list-style-type: none"> <li>• This is enabled when the Baton pass status (own station) (SB0047) is OFF.</li> <li>• Holds the data immediately before the error.</li> <li>• This is enabled only for normal stations in the Baton pass status (each station) (SW00A0 to SW00A7).</li> <li>• Reserved stations and stations higher than the maximum station number are ignored.</li> </ul>		b15	b14	b13	b12	b11	b10	b9	b8	b7	b6	b5	b4	b3	b2	b1	b0	SW00E0	16	15	14	13	12	11	10	9	8	7	6	5	4	3	2	1	SW00E1	32	31	30	29	28	27	26	25	24	23	22	21	20	19	18	17	SW00E2	48	47	46	45	44	43	42	41	40	39	38	37	36	35	34	33	SW00E3	64	63	62	61	60	59	58	57	56	55	54	53	52	51	50	49	SW00E4	80	79	78	77	76	75	74	73	72	71	70	69	68	67	66	65	SW00E5	96	95	94	93	92	91	90	89	88	87	86	85	84	83	82	81	SW00E6	112	111	110	109	108	107	106	105	104	103	102	101	100	99	98	97	SW00E7	—	—	—	—	—	—	—	—	120	119	118	117	116	115	114	113	<input type="radio"/>	<input type="radio"/>
	b15	b14	b13	b12	b11	b10	b9	b8	b7	b6	b5	b4	b3	b2	b1	b0																																																																																																																																													
SW00E0	16	15	14	13	12	11	10	9	8	7	6	5	4	3	2	1																																																																																																																																													
SW00E1	32	31	30	29	28	27	26	25	24	23	22	21	20	19	18	17																																																																																																																																													
SW00E2	48	47	46	45	44	43	42	41	40	39	38	37	36	35	34	33																																																																																																																																													
SW00E3	64	63	62	61	60	59	58	57	56	55	54	53	52	51	50	49																																																																																																																																													
SW00E4	80	79	78	77	76	75	74	73	72	71	70	69	68	67	66	65																																																																																																																																													
SW00E5	96	95	94	93	92	91	90	89	88	87	86	85	84	83	82	81																																																																																																																																													
SW00E6	112	111	110	109	108	107	106	105	104	103	102	101	100	99	98	97																																																																																																																																													
SW00E7	—	—	—	—	—	—	—	—	120	119	118	117	116	115	114	113																																																																																																																																													
SW00E8 to SW00EF	Station type match status	<p>Stores the match status between the station type set in the master station and that of the device station.</p> <ul style="list-style-type: none"> <li>• 0: Station type match</li> <li>• 1: Station type mismatch</li> </ul> <table border="1"> <thead> <tr> <th></th> <th>b15</th><th>b14</th><th>b13</th><th>b12</th><th>b11</th><th>b10</th><th>b9</th><th>b8</th><th>b7</th><th>b6</th><th>b5</th><th>b4</th><th>b3</th><th>b2</th><th>b1</th><th>b0</th> </tr> </thead> <tbody> <tr><td>SW00E8</td><td>16</td><td>15</td><td>14</td><td>13</td><td>12</td><td>11</td><td>10</td><td>9</td><td>8</td><td>7</td><td>6</td><td>5</td><td>4</td><td>3</td><td>2</td><td>1</td></tr> <tr><td>SW00E9</td><td>32</td><td>31</td><td>30</td><td>29</td><td>28</td><td>27</td><td>26</td><td>25</td><td>24</td><td>23</td><td>22</td><td>21</td><td>20</td><td>19</td><td>18</td><td>17</td></tr> <tr><td>SW00EA</td><td>48</td><td>47</td><td>46</td><td>45</td><td>44</td><td>43</td><td>42</td><td>41</td><td>40</td><td>39</td><td>38</td><td>37</td><td>36</td><td>35</td><td>34</td><td>33</td></tr> <tr><td>SW00EB</td><td>64</td><td>63</td><td>62</td><td>61</td><td>60</td><td>59</td><td>58</td><td>57</td><td>56</td><td>55</td><td>54</td><td>53</td><td>52</td><td>51</td><td>50</td><td>49</td></tr> <tr><td>SW00EC</td><td>80</td><td>79</td><td>78</td><td>77</td><td>76</td><td>75</td><td>74</td><td>73</td><td>72</td><td>71</td><td>70</td><td>69</td><td>68</td><td>67</td><td>66</td><td>65</td></tr> <tr><td>SW00ED</td><td>96</td><td>95</td><td>94</td><td>93</td><td>92</td><td>91</td><td>90</td><td>89</td><td>88</td><td>87</td><td>86</td><td>85</td><td>84</td><td>83</td><td>82</td><td>81</td></tr> <tr><td>SW00EE</td><td>112</td><td>111</td><td>110</td><td>109</td><td>108</td><td>107</td><td>106</td><td>105</td><td>104</td><td>103</td><td>102</td><td>101</td><td>100</td><td>99</td><td>98</td><td>97</td></tr> <tr><td>SW00EF</td><td>—</td><td>—</td><td>—</td><td>—</td><td>—</td><td>—</td><td>—</td><td>—</td><td>120</td><td>119</td><td>118</td><td>117</td><td>116</td><td>115</td><td>114</td><td>113</td></tr> </tbody> </table> <p>Each number in the table represents a station No. — is fixed to 0.</p> <p>(Conditions)</p> <ul style="list-style-type: none"> <li>• This is enabled only for the station in which Network connection status (SW00B8 to SW00BF) is ON and is connected to the network.</li> </ul>		b15	b14	b13	b12	b11	b10	b9	b8	b7	b6	b5	b4	b3	b2	b1	b0	SW00E8	16	15	14	13	12	11	10	9	8	7	6	5	4	3	2	1	SW00E9	32	31	30	29	28	27	26	25	24	23	22	21	20	19	18	17	SW00EA	48	47	46	45	44	43	42	41	40	39	38	37	36	35	34	33	SW00EB	64	63	62	61	60	59	58	57	56	55	54	53	52	51	50	49	SW00EC	80	79	78	77	76	75	74	73	72	71	70	69	68	67	66	65	SW00ED	96	95	94	93	92	91	90	89	88	87	86	85	84	83	82	81	SW00EE	112	111	110	109	108	107	106	105	104	103	102	101	100	99	98	97	SW00EF	—	—	—	—	—	—	—	—	120	119	118	117	116	115	114	113	<input type="radio"/>	<input type="radio"/>
	b15	b14	b13	b12	b11	b10	b9	b8	b7	b6	b5	b4	b3	b2	b1	b0																																																																																																																																													
SW00E8	16	15	14	13	12	11	10	9	8	7	6	5	4	3	2	1																																																																																																																																													
SW00E9	32	31	30	29	28	27	26	25	24	23	22	21	20	19	18	17																																																																																																																																													
SW00EA	48	47	46	45	44	43	42	41	40	39	38	37	36	35	34	33																																																																																																																																													
SW00EB	64	63	62	61	60	59	58	57	56	55	54	53	52	51	50	49																																																																																																																																													
SW00EC	80	79	78	77	76	75	74	73	72	71	70	69	68	67	66	65																																																																																																																																													
SW00ED	96	95	94	93	92	91	90	89	88	87	86	85	84	83	82	81																																																																																																																																													
SW00EE	112	111	110	109	108	107	106	105	104	103	102	101	100	99	98	97																																																																																																																																													
SW00EF	—	—	—	—	—	—	—	—	120	119	118	117	116	115	114	113																																																																																																																																													



Number	Name	Description	Availability																																																																																																																																																										
			Master station	Local station																																																																																																																																																									
SW00F0 to SW00F7	CPU RUN status (each station)	<p>Stores the RUN status of each station.</p> <ul style="list-style-type: none"> <li>• 0: RUN, STEP-RUN</li> <li>• 1: STOP, PAUSE, stop error</li> </ul> <table border="1"> <thead> <tr> <th></th> <th>b15</th> <th>b14</th> <th>b13</th> <th>b12</th> <th>b11</th> <th>b10</th> <th>b9</th> <th>b8</th> <th>b7</th> <th>b6</th> <th>b5</th> <th>b4</th> <th>b3</th> <th>b2</th> <th>b1</th> <th>b0</th> </tr> </thead> <tbody> <tr> <td>SW00F0</td> <td>16</td> <td>15</td> <td>14</td> <td>13</td> <td>12</td> <td>11</td> <td>10</td> <td>9</td> <td>8</td> <td>7</td> <td>6</td> <td>5</td> <td>4</td> <td>3</td> <td>2</td> <td>1</td> </tr> <tr> <td>SW00F1</td> <td>32</td> <td>31</td> <td>30</td> <td>29</td> <td>28</td> <td>27</td> <td>26</td> <td>25</td> <td>24</td> <td>23</td> <td>22</td> <td>21</td> <td>20</td> <td>19</td> <td>18</td> <td>17</td> </tr> <tr> <td>SW00F2</td> <td>48</td> <td>47</td> <td>46</td> <td>45</td> <td>44</td> <td>43</td> <td>42</td> <td>41</td> <td>40</td> <td>39</td> <td>38</td> <td>37</td> <td>36</td> <td>35</td> <td>34</td> <td>33</td> </tr> <tr> <td>SW00F3</td> <td>64</td> <td>63</td> <td>62</td> <td>61</td> <td>60</td> <td>59</td> <td>58</td> <td>57</td> <td>56</td> <td>55</td> <td>54</td> <td>53</td> <td>52</td> <td>51</td> <td>50</td> <td>49</td> </tr> <tr> <td>SW00F4</td> <td>80</td> <td>79</td> <td>78</td> <td>77</td> <td>76</td> <td>75</td> <td>74</td> <td>73</td> <td>72</td> <td>71</td> <td>70</td> <td>69</td> <td>68</td> <td>67</td> <td>66</td> <td>65</td> </tr> <tr> <td>SW00F5</td> <td>96</td> <td>95</td> <td>94</td> <td>93</td> <td>92</td> <td>91</td> <td>90</td> <td>89</td> <td>88</td> <td>87</td> <td>86</td> <td>85</td> <td>84</td> <td>83</td> <td>82</td> <td>81</td> </tr> <tr> <td>SW00F6</td> <td>112</td> <td>111</td> <td>110</td> <td>109</td> <td>108</td> <td>107</td> <td>106</td> <td>105</td> <td>104</td> <td>103</td> <td>102</td> <td>101</td> <td>100</td> <td>99</td> <td>98</td> <td>97</td> </tr> <tr> <td>SW00F7</td> <td>—</td> <td>—</td> <td>—</td> <td>—</td> <td>—</td> <td>—</td> <td>—</td> <td>—</td> <td>120</td> <td>119</td> <td>118</td> <td>117</td> <td>116</td> <td>115</td> <td>114</td> <td>113</td> </tr> </tbody> </table> <p>Each number in the table represents a station No. — is fixed to 0.</p> <p>(Conditions)</p> <ul style="list-style-type: none"> <li>• This is enabled when the Baton pass status (own station) (SB0047) is OFF.</li> <li>• Holds the data immediately before the error.</li> <li>• This is enabled only for normal stations in the Baton pass status (each station) (SW00A0 to SW00A7).</li> <li>• Reserved stations and stations higher than the maximum station number are ignored.</li> </ul>		b15	b14	b13	b12	b11	b10	b9	b8	b7	b6	b5	b4	b3	b2	b1	b0	SW00F0	16	15	14	13	12	11	10	9	8	7	6	5	4	3	2	1	SW00F1	32	31	30	29	28	27	26	25	24	23	22	21	20	19	18	17	SW00F2	48	47	46	45	44	43	42	41	40	39	38	37	36	35	34	33	SW00F3	64	63	62	61	60	59	58	57	56	55	54	53	52	51	50	49	SW00F4	80	79	78	77	76	75	74	73	72	71	70	69	68	67	66	65	SW00F5	96	95	94	93	92	91	90	89	88	87	86	85	84	83	82	81	SW00F6	112	111	110	109	108	107	106	105	104	103	102	101	100	99	98	97	SW00F7	—	—	—	—	—	—	—	—	120	119	118	117	116	115	114	113	○	○
	b15	b14	b13	b12	b11	b10	b9	b8	b7	b6	b5	b4	b3	b2	b1	b0																																																																																																																																													
SW00F0	16	15	14	13	12	11	10	9	8	7	6	5	4	3	2	1																																																																																																																																													
SW00F1	32	31	30	29	28	27	26	25	24	23	22	21	20	19	18	17																																																																																																																																													
SW00F2	48	47	46	45	44	43	42	41	40	39	38	37	36	35	34	33																																																																																																																																													
SW00F3	64	63	62	61	60	59	58	57	56	55	54	53	52	51	50	49																																																																																																																																													
SW00F4	80	79	78	77	76	75	74	73	72	71	70	69	68	67	66	65																																																																																																																																													
SW00F5	96	95	94	93	92	91	90	89	88	87	86	85	84	83	82	81																																																																																																																																													
SW00F6	112	111	110	109	108	107	106	105	104	103	102	101	100	99	98	97																																																																																																																																													
SW00F7	—	—	—	—	—	—	—	—	120	119	118	117	116	115	114	113																																																																																																																																													
SW00F8 to SW00FF	Network number match status	<p>Stores the match status between the network number of the master station and that of the device station.</p> <ul style="list-style-type: none"> <li>• 0: Network number match</li> <li>• 1: Network number mismatch</li> </ul> <table border="1"> <thead> <tr> <th></th> <th>b15</th> <th>b14</th> <th>b13</th> <th>b12</th> <th>b11</th> <th>b10</th> <th>b9</th> <th>b8</th> <th>b7</th> <th>b6</th> <th>b5</th> <th>b4</th> <th>b3</th> <th>b2</th> <th>b1</th> <th>b0</th> </tr> </thead> <tbody> <tr> <td>SW00F8</td> <td>16</td> <td>15</td> <td>14</td> <td>13</td> <td>12</td> <td>11</td> <td>10</td> <td>9</td> <td>8</td> <td>7</td> <td>6</td> <td>5</td> <td>4</td> <td>3</td> <td>2</td> <td>1</td> </tr> <tr> <td>SW00F9</td> <td>32</td> <td>31</td> <td>30</td> <td>29</td> <td>28</td> <td>27</td> <td>26</td> <td>25</td> <td>24</td> <td>23</td> <td>22</td> <td>21</td> <td>20</td> <td>19</td> <td>18</td> <td>17</td> </tr> <tr> <td>SW00FA</td> <td>48</td> <td>47</td> <td>46</td> <td>45</td> <td>44</td> <td>43</td> <td>42</td> <td>41</td> <td>40</td> <td>39</td> <td>38</td> <td>37</td> <td>36</td> <td>35</td> <td>34</td> <td>33</td> </tr> <tr> <td>SW00FB</td> <td>64</td> <td>63</td> <td>62</td> <td>61</td> <td>60</td> <td>59</td> <td>58</td> <td>57</td> <td>56</td> <td>55</td> <td>54</td> <td>53</td> <td>52</td> <td>51</td> <td>50</td> <td>49</td> </tr> <tr> <td>SW00FC</td> <td>80</td> <td>79</td> <td>78</td> <td>77</td> <td>76</td> <td>75</td> <td>74</td> <td>73</td> <td>72</td> <td>71</td> <td>70</td> <td>69</td> <td>68</td> <td>67</td> <td>66</td> <td>65</td> </tr> <tr> <td>SW00FD</td> <td>96</td> <td>95</td> <td>94</td> <td>93</td> <td>92</td> <td>91</td> <td>90</td> <td>89</td> <td>88</td> <td>87</td> <td>86</td> <td>85</td> <td>84</td> <td>83</td> <td>82</td> <td>81</td> </tr> <tr> <td>SW00FE</td> <td>112</td> <td>111</td> <td>110</td> <td>109</td> <td>108</td> <td>107</td> <td>106</td> <td>105</td> <td>104</td> <td>103</td> <td>102</td> <td>101</td> <td>100</td> <td>99</td> <td>98</td> <td>97</td> </tr> <tr> <td>SW00FF</td> <td>—</td> <td>—</td> <td>—</td> <td>—</td> <td>—</td> <td>—</td> <td>—</td> <td>—</td> <td>120</td> <td>119</td> <td>118</td> <td>117</td> <td>116</td> <td>115</td> <td>114</td> <td>113</td> </tr> </tbody> </table> <p>Each number in the table represents a station No. — is fixed to 0.</p> <p>(Conditions)</p> <p>This is enabled when the Baton pass status (own station) (SB0047) is OFF.</p>		b15	b14	b13	b12	b11	b10	b9	b8	b7	b6	b5	b4	b3	b2	b1	b0	SW00F8	16	15	14	13	12	11	10	9	8	7	6	5	4	3	2	1	SW00F9	32	31	30	29	28	27	26	25	24	23	22	21	20	19	18	17	SW00FA	48	47	46	45	44	43	42	41	40	39	38	37	36	35	34	33	SW00FB	64	63	62	61	60	59	58	57	56	55	54	53	52	51	50	49	SW00FC	80	79	78	77	76	75	74	73	72	71	70	69	68	67	66	65	SW00FD	96	95	94	93	92	91	90	89	88	87	86	85	84	83	82	81	SW00FE	112	111	110	109	108	107	106	105	104	103	102	101	100	99	98	97	SW00FF	—	—	—	—	—	—	—	—	120	119	118	117	116	115	114	113	○	○
	b15	b14	b13	b12	b11	b10	b9	b8	b7	b6	b5	b4	b3	b2	b1	b0																																																																																																																																													
SW00F8	16	15	14	13	12	11	10	9	8	7	6	5	4	3	2	1																																																																																																																																													
SW00F9	32	31	30	29	28	27	26	25	24	23	22	21	20	19	18	17																																																																																																																																													
SW00FA	48	47	46	45	44	43	42	41	40	39	38	37	36	35	34	33																																																																																																																																													
SW00FB	64	63	62	61	60	59	58	57	56	55	54	53	52	51	50	49																																																																																																																																													
SW00FC	80	79	78	77	76	75	74	73	72	71	70	69	68	67	66	65																																																																																																																																													
SW00FD	96	95	94	93	92	91	90	89	88	87	86	85	84	83	82	81																																																																																																																																													
SW00FE	112	111	110	109	108	107	106	105	104	103	102	101	100	99	98	97																																																																																																																																													
SW00FF	—	—	—	—	—	—	—	—	120	119	118	117	116	115	114	113																																																																																																																																													

Number	Name	Description	Availability																																																																																																																																																										
			Master station	Local station																																																																																																																																																									
SW0100 to SW0107	Operation status (each station) (1)	<p>Stores the moderate/major error or stop error status of each station. When the target station is the master/local module, the occurrence status on the control CPU is stored.</p> <ul style="list-style-type: none"> <li>• 0: No moderate/major error (stop error)</li> <li>• 1: Moderate/major error (stop error) occurring</li> </ul> <table border="1"> <thead> <tr> <th></th> <th>b15</th><th>b14</th><th>b13</th><th>b12</th><th>b11</th><th>b10</th><th>b9</th><th>b8</th><th>b7</th><th>b6</th><th>b5</th><th>b4</th><th>b3</th><th>b2</th><th>b1</th><th>b0</th> </tr> </thead> <tbody> <tr> <td>SW0100</td> <td>16</td><td>15</td><td>14</td><td>13</td><td>12</td><td>11</td><td>10</td><td>9</td><td>8</td><td>7</td><td>6</td><td>5</td><td>4</td><td>3</td><td>2</td><td>1</td> </tr> <tr> <td>SW0101</td> <td>32</td><td>31</td><td>30</td><td>29</td><td>28</td><td>27</td><td>26</td><td>25</td><td>24</td><td>23</td><td>22</td><td>21</td><td>20</td><td>19</td><td>18</td><td>17</td> </tr> <tr> <td>SW0102</td> <td>48</td><td>47</td><td>46</td><td>45</td><td>44</td><td>43</td><td>42</td><td>41</td><td>40</td><td>39</td><td>38</td><td>37</td><td>36</td><td>35</td><td>34</td><td>33</td> </tr> <tr> <td>SW0103</td> <td>64</td><td>63</td><td>62</td><td>61</td><td>60</td><td>59</td><td>58</td><td>57</td><td>56</td><td>55</td><td>54</td><td>53</td><td>52</td><td>51</td><td>50</td><td>49</td> </tr> <tr> <td>SW0104</td> <td>80</td><td>79</td><td>78</td><td>77</td><td>76</td><td>75</td><td>74</td><td>73</td><td>72</td><td>71</td><td>70</td><td>69</td><td>68</td><td>67</td><td>66</td><td>65</td> </tr> <tr> <td>SW0105</td> <td>96</td><td>95</td><td>94</td><td>93</td><td>92</td><td>91</td><td>90</td><td>89</td><td>88</td><td>87</td><td>86</td><td>85</td><td>84</td><td>83</td><td>82</td><td>81</td> </tr> <tr> <td>SW0106</td> <td>112</td><td>111</td><td>110</td><td>109</td><td>108</td><td>107</td><td>106</td><td>105</td><td>104</td><td>103</td><td>102</td><td>101</td><td>100</td><td>99</td><td>98</td><td>97</td> </tr> <tr> <td>SW0107</td> <td>—</td><td>—</td><td>—</td><td>—</td><td>—</td><td>—</td><td>—</td><td>—</td><td>120</td><td>119</td><td>118</td><td>117</td><td>116</td><td>115</td><td>114</td><td>113</td> </tr> </tbody> </table> <p>Each number in the table represents a station No. — is fixed to 0.</p> <p>(Conditions)</p> <ul style="list-style-type: none"> <li>• This is enabled when the Baton pass status (own station) (SB0047) is OFF.</li> <li>• Holds the data immediately before the error.</li> <li>• This is enabled only for normal stations in the Baton pass status (each station) (SW00A0 to SW00A7).</li> <li>• Reserved stations and stations higher than the maximum station number are ignored.</li> </ul>		b15	b14	b13	b12	b11	b10	b9	b8	b7	b6	b5	b4	b3	b2	b1	b0	SW0100	16	15	14	13	12	11	10	9	8	7	6	5	4	3	2	1	SW0101	32	31	30	29	28	27	26	25	24	23	22	21	20	19	18	17	SW0102	48	47	46	45	44	43	42	41	40	39	38	37	36	35	34	33	SW0103	64	63	62	61	60	59	58	57	56	55	54	53	52	51	50	49	SW0104	80	79	78	77	76	75	74	73	72	71	70	69	68	67	66	65	SW0105	96	95	94	93	92	91	90	89	88	87	86	85	84	83	82	81	SW0106	112	111	110	109	108	107	106	105	104	103	102	101	100	99	98	97	SW0107	—	—	—	—	—	—	—	—	120	119	118	117	116	115	114	113	<input type="radio"/>	<input type="radio"/>
	b15	b14	b13	b12	b11	b10	b9	b8	b7	b6	b5	b4	b3	b2	b1	b0																																																																																																																																													
SW0100	16	15	14	13	12	11	10	9	8	7	6	5	4	3	2	1																																																																																																																																													
SW0101	32	31	30	29	28	27	26	25	24	23	22	21	20	19	18	17																																																																																																																																													
SW0102	48	47	46	45	44	43	42	41	40	39	38	37	36	35	34	33																																																																																																																																													
SW0103	64	63	62	61	60	59	58	57	56	55	54	53	52	51	50	49																																																																																																																																													
SW0104	80	79	78	77	76	75	74	73	72	71	70	69	68	67	66	65																																																																																																																																													
SW0105	96	95	94	93	92	91	90	89	88	87	86	85	84	83	82	81																																																																																																																																													
SW0106	112	111	110	109	108	107	106	105	104	103	102	101	100	99	98	97																																																																																																																																													
SW0107	—	—	—	—	—	—	—	—	120	119	118	117	116	115	114	113																																																																																																																																													
SW0108 to SW010F	Station number duplication occurrence status	<p>Stores the occurrence status of station number duplication.</p> <ul style="list-style-type: none"> <li>• 0: No duplication of station number</li> <li>• 1: Station number duplicated</li> </ul> <table border="1"> <thead> <tr> <th></th> <th>b15</th><th>b14</th><th>b13</th><th>b12</th><th>b11</th><th>b10</th><th>b9</th><th>b8</th><th>b7</th><th>b6</th><th>b5</th><th>b4</th><th>b3</th><th>b2</th><th>b1</th><th>b0</th> </tr> </thead> <tbody> <tr> <td>SW0108</td> <td>16</td><td>15</td><td>14</td><td>13</td><td>12</td><td>11</td><td>10</td><td>9</td><td>8</td><td>7</td><td>6</td><td>5</td><td>4</td><td>3</td><td>2</td><td>1</td> </tr> <tr> <td>SW0109</td> <td>32</td><td>31</td><td>30</td><td>29</td><td>28</td><td>27</td><td>26</td><td>25</td><td>24</td><td>23</td><td>22</td><td>21</td><td>20</td><td>19</td><td>18</td><td>17</td> </tr> <tr> <td>SW010A</td> <td>48</td><td>47</td><td>46</td><td>45</td><td>44</td><td>43</td><td>42</td><td>41</td><td>40</td><td>39</td><td>38</td><td>37</td><td>36</td><td>35</td><td>34</td><td>33</td> </tr> <tr> <td>SW010B</td> <td>64</td><td>63</td><td>62</td><td>61</td><td>60</td><td>59</td><td>58</td><td>57</td><td>56</td><td>55</td><td>54</td><td>53</td><td>52</td><td>51</td><td>50</td><td>49</td> </tr> <tr> <td>SW010C</td> <td>80</td><td>79</td><td>78</td><td>77</td><td>76</td><td>75</td><td>74</td><td>73</td><td>72</td><td>71</td><td>70</td><td>69</td><td>68</td><td>67</td><td>66</td><td>65</td> </tr> <tr> <td>SW010D</td> <td>96</td><td>95</td><td>94</td><td>93</td><td>92</td><td>91</td><td>90</td><td>89</td><td>88</td><td>87</td><td>86</td><td>85</td><td>84</td><td>83</td><td>82</td><td>81</td> </tr> <tr> <td>SW010E</td> <td>112</td><td>111</td><td>110</td><td>109</td><td>108</td><td>107</td><td>106</td><td>105</td><td>104</td><td>103</td><td>102</td><td>101</td><td>100</td><td>99</td><td>98</td><td>97</td> </tr> <tr> <td>SW010F</td> <td>—</td><td>—</td><td>—</td><td>—</td><td>—</td><td>—</td><td>—</td><td>—</td><td>120</td><td>119</td><td>118</td><td>117</td><td>116</td><td>115</td><td>114</td><td>113</td> </tr> </tbody> </table> <p>Each number in the table represents a station No. — is fixed to 0.</p> <p>(Conditions)</p> <p>This is enabled when the Baton pass status (own station) (SB0047) is OFF.</p>		b15	b14	b13	b12	b11	b10	b9	b8	b7	b6	b5	b4	b3	b2	b1	b0	SW0108	16	15	14	13	12	11	10	9	8	7	6	5	4	3	2	1	SW0109	32	31	30	29	28	27	26	25	24	23	22	21	20	19	18	17	SW010A	48	47	46	45	44	43	42	41	40	39	38	37	36	35	34	33	SW010B	64	63	62	61	60	59	58	57	56	55	54	53	52	51	50	49	SW010C	80	79	78	77	76	75	74	73	72	71	70	69	68	67	66	65	SW010D	96	95	94	93	92	91	90	89	88	87	86	85	84	83	82	81	SW010E	112	111	110	109	108	107	106	105	104	103	102	101	100	99	98	97	SW010F	—	—	—	—	—	—	—	—	120	119	118	117	116	115	114	113	<input type="radio"/>	<input type="radio"/>
	b15	b14	b13	b12	b11	b10	b9	b8	b7	b6	b5	b4	b3	b2	b1	b0																																																																																																																																													
SW0108	16	15	14	13	12	11	10	9	8	7	6	5	4	3	2	1																																																																																																																																													
SW0109	32	31	30	29	28	27	26	25	24	23	22	21	20	19	18	17																																																																																																																																													
SW010A	48	47	46	45	44	43	42	41	40	39	38	37	36	35	34	33																																																																																																																																													
SW010B	64	63	62	61	60	59	58	57	56	55	54	53	52	51	50	49																																																																																																																																													
SW010C	80	79	78	77	76	75	74	73	72	71	70	69	68	67	66	65																																																																																																																																													
SW010D	96	95	94	93	92	91	90	89	88	87	86	85	84	83	82	81																																																																																																																																													
SW010E	112	111	110	109	108	107	106	105	104	103	102	101	100	99	98	97																																																																																																																																													
SW010F	—	—	—	—	—	—	—	—	120	119	118	117	116	115	114	113																																																																																																																																													



Number	Name	Description	Availability																																																																																																																																																										
			Master station	Local station																																																																																																																																																									
SW0110 to SW0117	Operation status (each station) (2)	<p>Stores the minor error or continuation error status of each station.</p> <p>When the target station is the master/local module, the occurrence status on the control CPU is stored.</p> <ul style="list-style-type: none"> <li>• 0: Normal operation, or a moderate/major error (stop error) occurring</li> <li>• 1: Minor error (continuation error) occurring</li> </ul> <table border="1"> <thead> <tr> <th></th> <th>b15</th> <th>b14</th> <th>b13</th> <th>b12</th> <th>b11</th> <th>b10</th> <th>b9</th> <th>b8</th> <th>b7</th> <th>b6</th> <th>b5</th> <th>b4</th> <th>b3</th> <th>b2</th> <th>b1</th> <th>b0</th> </tr> </thead> <tbody> <tr> <td>SW0110</td> <td>16</td> <td>15</td> <td>14</td> <td>13</td> <td>12</td> <td>11</td> <td>10</td> <td>9</td> <td>8</td> <td>7</td> <td>6</td> <td>5</td> <td>4</td> <td>3</td> <td>2</td> <td>1</td> </tr> <tr> <td>SW0111</td> <td>32</td> <td>31</td> <td>30</td> <td>29</td> <td>28</td> <td>27</td> <td>26</td> <td>25</td> <td>24</td> <td>23</td> <td>22</td> <td>21</td> <td>20</td> <td>19</td> <td>18</td> <td>17</td> </tr> <tr> <td>SW0112</td> <td>48</td> <td>47</td> <td>46</td> <td>45</td> <td>44</td> <td>43</td> <td>42</td> <td>41</td> <td>40</td> <td>39</td> <td>38</td> <td>37</td> <td>36</td> <td>35</td> <td>34</td> <td>33</td> </tr> <tr> <td>SW0113</td> <td>64</td> <td>63</td> <td>62</td> <td>61</td> <td>60</td> <td>59</td> <td>58</td> <td>57</td> <td>56</td> <td>55</td> <td>54</td> <td>53</td> <td>52</td> <td>51</td> <td>50</td> <td>49</td> </tr> <tr> <td>SW0114</td> <td>80</td> <td>79</td> <td>78</td> <td>77</td> <td>76</td> <td>75</td> <td>74</td> <td>73</td> <td>72</td> <td>71</td> <td>70</td> <td>69</td> <td>68</td> <td>67</td> <td>66</td> <td>65</td> </tr> <tr> <td>SW0115</td> <td>96</td> <td>95</td> <td>94</td> <td>93</td> <td>92</td> <td>91</td> <td>90</td> <td>89</td> <td>88</td> <td>87</td> <td>86</td> <td>85</td> <td>84</td> <td>83</td> <td>82</td> <td>81</td> </tr> <tr> <td>SW0116</td> <td>112</td> <td>111</td> <td>110</td> <td>109</td> <td>108</td> <td>107</td> <td>106</td> <td>105</td> <td>104</td> <td>103</td> <td>102</td> <td>101</td> <td>100</td> <td>99</td> <td>98</td> <td>97</td> </tr> <tr> <td>SW0117</td> <td>—</td> <td>—</td> <td>—</td> <td>—</td> <td>—</td> <td>—</td> <td>—</td> <td>—</td> <td>120</td> <td>119</td> <td>118</td> <td>117</td> <td>116</td> <td>115</td> <td>114</td> <td>113</td> </tr> </tbody> </table> <p>Each number in the table represents a station No. — is fixed to 0.</p> <p>(Conditions)</p> <ul style="list-style-type: none"> <li>• This is enabled when the Baton pass status (own station) (SB0047) is OFF.</li> <li>• Holds the data immediately before the error.</li> <li>• This is enabled only for normal stations in the Baton pass status (each station) (SW00A0 to SW00A7).</li> <li>• Reserved stations and stations higher than the maximum station number are ignored.</li> </ul>		b15	b14	b13	b12	b11	b10	b9	b8	b7	b6	b5	b4	b3	b2	b1	b0	SW0110	16	15	14	13	12	11	10	9	8	7	6	5	4	3	2	1	SW0111	32	31	30	29	28	27	26	25	24	23	22	21	20	19	18	17	SW0112	48	47	46	45	44	43	42	41	40	39	38	37	36	35	34	33	SW0113	64	63	62	61	60	59	58	57	56	55	54	53	52	51	50	49	SW0114	80	79	78	77	76	75	74	73	72	71	70	69	68	67	66	65	SW0115	96	95	94	93	92	91	90	89	88	87	86	85	84	83	82	81	SW0116	112	111	110	109	108	107	106	105	104	103	102	101	100	99	98	97	SW0117	—	—	—	—	—	—	—	—	120	119	118	117	116	115	114	113	○	○
	b15	b14	b13	b12	b11	b10	b9	b8	b7	b6	b5	b4	b3	b2	b1	b0																																																																																																																																													
SW0110	16	15	14	13	12	11	10	9	8	7	6	5	4	3	2	1																																																																																																																																													
SW0111	32	31	30	29	28	27	26	25	24	23	22	21	20	19	18	17																																																																																																																																													
SW0112	48	47	46	45	44	43	42	41	40	39	38	37	36	35	34	33																																																																																																																																													
SW0113	64	63	62	61	60	59	58	57	56	55	54	53	52	51	50	49																																																																																																																																													
SW0114	80	79	78	77	76	75	74	73	72	71	70	69	68	67	66	65																																																																																																																																													
SW0115	96	95	94	93	92	91	90	89	88	87	86	85	84	83	82	81																																																																																																																																													
SW0116	112	111	110	109	108	107	106	105	104	103	102	101	100	99	98	97																																																																																																																																													
SW0117	—	—	—	—	—	—	—	—	120	119	118	117	116	115	114	113																																																																																																																																													
SW0120 to SW0127	PORT1 current error frame reception status (each station) (1)	<p>Stores the station number occurring a receive frame error line status caution level in each station's PORT1.</p> <ul style="list-style-type: none"> <li>• 0: A receive frame error line status caution level has not yet been occurred in each station's PORT1.</li> <li>• 1: A receive frame error line status caution level has been occurred in each station's PORT1.</li> </ul> <p>When Clear communication error count (SB0006) is turned ON, the stored status is cleared.</p> <table border="1"> <thead> <tr> <th></th> <th>b15</th> <th>b14</th> <th>b13</th> <th>b12</th> <th>b11</th> <th>b10</th> <th>b9</th> <th>b8</th> <th>b7</th> <th>b6</th> <th>b5</th> <th>b4</th> <th>b3</th> <th>b2</th> <th>b1</th> <th>b0</th> </tr> </thead> <tbody> <tr> <td>SW0120</td> <td>16</td> <td>15</td> <td>14</td> <td>13</td> <td>12</td> <td>11</td> <td>10</td> <td>9</td> <td>8</td> <td>7</td> <td>6</td> <td>5</td> <td>4</td> <td>3</td> <td>2</td> <td>1</td> </tr> <tr> <td>SW0121</td> <td>32</td> <td>31</td> <td>30</td> <td>29</td> <td>28</td> <td>27</td> <td>26</td> <td>25</td> <td>24</td> <td>23</td> <td>22</td> <td>21</td> <td>20</td> <td>19</td> <td>18</td> <td>17</td> </tr> <tr> <td>SW0122</td> <td>48</td> <td>47</td> <td>46</td> <td>45</td> <td>44</td> <td>43</td> <td>42</td> <td>41</td> <td>40</td> <td>39</td> <td>38</td> <td>37</td> <td>36</td> <td>35</td> <td>34</td> <td>33</td> </tr> <tr> <td>SW0123</td> <td>64</td> <td>63</td> <td>62</td> <td>61</td> <td>60</td> <td>59</td> <td>58</td> <td>57</td> <td>56</td> <td>55</td> <td>54</td> <td>53</td> <td>52</td> <td>51</td> <td>50</td> <td>49</td> </tr> <tr> <td>SW0124</td> <td>80</td> <td>79</td> <td>78</td> <td>77</td> <td>76</td> <td>75</td> <td>74</td> <td>73</td> <td>72</td> <td>71</td> <td>70</td> <td>69</td> <td>68</td> <td>67</td> <td>66</td> <td>65</td> </tr> <tr> <td>SW0125</td> <td>96</td> <td>95</td> <td>94</td> <td>93</td> <td>92</td> <td>91</td> <td>90</td> <td>89</td> <td>88</td> <td>87</td> <td>86</td> <td>85</td> <td>84</td> <td>83</td> <td>82</td> <td>81</td> </tr> <tr> <td>SW0126</td> <td>112</td> <td>111</td> <td>110</td> <td>109</td> <td>108</td> <td>107</td> <td>106</td> <td>105</td> <td>104</td> <td>103</td> <td>102</td> <td>101</td> <td>100</td> <td>99</td> <td>98</td> <td>97</td> </tr> <tr> <td>SW0127</td> <td>—</td> <td>—</td> <td>—</td> <td>—</td> <td>—</td> <td>—</td> <td>—</td> <td>—</td> <td>120</td> <td>119</td> <td>118</td> <td>117</td> <td>116</td> <td>115</td> <td>114</td> <td>113</td> </tr> </tbody> </table> <p>Each number in the table represents a station No. — is fixed to 0.</p> <p>(Conditions)</p> <ul style="list-style-type: none"> <li>• This is enabled when the Baton pass status (own station) (SB0047) is OFF.</li> <li>• Holds the data immediately before the error.</li> <li>• This is enabled only for normal stations in the Baton pass status (each station) (SW00A0 to SW00A7).</li> </ul>		b15	b14	b13	b12	b11	b10	b9	b8	b7	b6	b5	b4	b3	b2	b1	b0	SW0120	16	15	14	13	12	11	10	9	8	7	6	5	4	3	2	1	SW0121	32	31	30	29	28	27	26	25	24	23	22	21	20	19	18	17	SW0122	48	47	46	45	44	43	42	41	40	39	38	37	36	35	34	33	SW0123	64	63	62	61	60	59	58	57	56	55	54	53	52	51	50	49	SW0124	80	79	78	77	76	75	74	73	72	71	70	69	68	67	66	65	SW0125	96	95	94	93	92	91	90	89	88	87	86	85	84	83	82	81	SW0126	112	111	110	109	108	107	106	105	104	103	102	101	100	99	98	97	SW0127	—	—	—	—	—	—	—	—	120	119	118	117	116	115	114	113	○	○
	b15	b14	b13	b12	b11	b10	b9	b8	b7	b6	b5	b4	b3	b2	b1	b0																																																																																																																																													
SW0120	16	15	14	13	12	11	10	9	8	7	6	5	4	3	2	1																																																																																																																																													
SW0121	32	31	30	29	28	27	26	25	24	23	22	21	20	19	18	17																																																																																																																																													
SW0122	48	47	46	45	44	43	42	41	40	39	38	37	36	35	34	33																																																																																																																																													
SW0123	64	63	62	61	60	59	58	57	56	55	54	53	52	51	50	49																																																																																																																																													
SW0124	80	79	78	77	76	75	74	73	72	71	70	69	68	67	66	65																																																																																																																																													
SW0125	96	95	94	93	92	91	90	89	88	87	86	85	84	83	82	81																																																																																																																																													
SW0126	112	111	110	109	108	107	106	105	104	103	102	101	100	99	98	97																																																																																																																																													
SW0127	—	—	—	—	—	—	—	—	120	119	118	117	116	115	114	113																																																																																																																																													

Number	Name	Description	Availability																																																																																																																																																										
			Master station	Local station																																																																																																																																																									
SW0128 to SW012F	PORT1 current error frame reception status (each station) (2)	<p>Stores the station number where a receive frame error line status warning level has occurred in each station's PORT1.</p> <ul style="list-style-type: none"> <li>• 0: A receive frame error line status warning level has not yet been occurred in each station's PORT1.</li> <li>• 1: A receive frame error line status warning level has been occurred in each station's PORT1.</li> </ul> <p>When Clear communication error count (SB0006) is turned ON, the stored status is cleared.</p> <table border="1"> <thead> <tr> <th></th> <th>b15</th> <th>b14</th> <th>b13</th> <th>b12</th> <th>b11</th> <th>b10</th> <th>b9</th> <th>b8</th> <th>b7</th> <th>b6</th> <th>b5</th> <th>b4</th> <th>b3</th> <th>b2</th> <th>b1</th> <th>b0</th> </tr> </thead> <tbody> <tr> <td>SW0128</td> <td>16</td> <td>15</td> <td>14</td> <td>13</td> <td>12</td> <td>11</td> <td>10</td> <td>9</td> <td>8</td> <td>7</td> <td>6</td> <td>5</td> <td>4</td> <td>3</td> <td>2</td> <td>1</td> </tr> <tr> <td>SW0129</td> <td>32</td> <td>31</td> <td>30</td> <td>29</td> <td>28</td> <td>27</td> <td>26</td> <td>25</td> <td>24</td> <td>23</td> <td>22</td> <td>21</td> <td>20</td> <td>19</td> <td>18</td> <td>17</td> </tr> <tr> <td>SW012A</td> <td>48</td> <td>47</td> <td>46</td> <td>45</td> <td>44</td> <td>43</td> <td>42</td> <td>41</td> <td>40</td> <td>39</td> <td>38</td> <td>37</td> <td>36</td> <td>35</td> <td>34</td> <td>33</td> </tr> <tr> <td>SW012B</td> <td>64</td> <td>63</td> <td>62</td> <td>61</td> <td>60</td> <td>59</td> <td>58</td> <td>57</td> <td>56</td> <td>55</td> <td>54</td> <td>53</td> <td>52</td> <td>51</td> <td>50</td> <td>49</td> </tr> <tr> <td>SW012C</td> <td>80</td> <td>79</td> <td>78</td> <td>77</td> <td>76</td> <td>75</td> <td>74</td> <td>73</td> <td>72</td> <td>71</td> <td>70</td> <td>69</td> <td>68</td> <td>67</td> <td>66</td> <td>65</td> </tr> <tr> <td>SW012D</td> <td>96</td> <td>95</td> <td>94</td> <td>93</td> <td>92</td> <td>91</td> <td>90</td> <td>89</td> <td>88</td> <td>87</td> <td>86</td> <td>85</td> <td>84</td> <td>83</td> <td>82</td> <td>81</td> </tr> <tr> <td>SW012E</td> <td>112</td> <td>111</td> <td>110</td> <td>109</td> <td>108</td> <td>107</td> <td>106</td> <td>105</td> <td>104</td> <td>103</td> <td>102</td> <td>101</td> <td>100</td> <td>99</td> <td>98</td> <td>97</td> </tr> <tr> <td>SW012F</td> <td>—</td> <td>—</td> <td>—</td> <td>—</td> <td>—</td> <td>—</td> <td>—</td> <td>—</td> <td>120</td> <td>119</td> <td>118</td> <td>117</td> <td>116</td> <td>115</td> <td>114</td> <td>113</td> </tr> </tbody> </table> <p>Each number in the table represents a station No. — is fixed to 0.</p> <p>(Conditions)</p> <ul style="list-style-type: none"> <li>• This is enabled when the Baton pass status (own station) (SB0047) is OFF.</li> <li>• Holds the data immediately before the error.</li> <li>• This is enabled only for normal stations in the Baton pass status (each station) (SW00A0 to SW00A7).</li> </ul>		b15	b14	b13	b12	b11	b10	b9	b8	b7	b6	b5	b4	b3	b2	b1	b0	SW0128	16	15	14	13	12	11	10	9	8	7	6	5	4	3	2	1	SW0129	32	31	30	29	28	27	26	25	24	23	22	21	20	19	18	17	SW012A	48	47	46	45	44	43	42	41	40	39	38	37	36	35	34	33	SW012B	64	63	62	61	60	59	58	57	56	55	54	53	52	51	50	49	SW012C	80	79	78	77	76	75	74	73	72	71	70	69	68	67	66	65	SW012D	96	95	94	93	92	91	90	89	88	87	86	85	84	83	82	81	SW012E	112	111	110	109	108	107	106	105	104	103	102	101	100	99	98	97	SW012F	—	—	—	—	—	—	—	—	120	119	118	117	116	115	114	113	○	○
	b15	b14	b13	b12	b11	b10	b9	b8	b7	b6	b5	b4	b3	b2	b1	b0																																																																																																																																													
SW0128	16	15	14	13	12	11	10	9	8	7	6	5	4	3	2	1																																																																																																																																													
SW0129	32	31	30	29	28	27	26	25	24	23	22	21	20	19	18	17																																																																																																																																													
SW012A	48	47	46	45	44	43	42	41	40	39	38	37	36	35	34	33																																																																																																																																													
SW012B	64	63	62	61	60	59	58	57	56	55	54	53	52	51	50	49																																																																																																																																													
SW012C	80	79	78	77	76	75	74	73	72	71	70	69	68	67	66	65																																																																																																																																													
SW012D	96	95	94	93	92	91	90	89	88	87	86	85	84	83	82	81																																																																																																																																													
SW012E	112	111	110	109	108	107	106	105	104	103	102	101	100	99	98	97																																																																																																																																													
SW012F	—	—	—	—	—	—	—	—	120	119	118	117	116	115	114	113																																																																																																																																													
SW0130 to SW0137	PORT2 current error frame reception status (each station) (1)	<p>Stores the station number where a receive frame error line status caution level has occurred in each station's PORT2.</p> <ul style="list-style-type: none"> <li>• 0: A receive frame error line status caution level has not yet been occurred in each station's PORT2.</li> <li>• 1: A receive frame error line status caution level has been occurred in each station's PORT2.</li> </ul> <p>When Clear communication error count (SB0006) is turned ON, the stored status is cleared.</p> <table border="1"> <thead> <tr> <th></th> <th>b15</th> <th>b14</th> <th>b13</th> <th>b12</th> <th>b11</th> <th>b10</th> <th>b9</th> <th>b8</th> <th>b7</th> <th>b6</th> <th>b5</th> <th>b4</th> <th>b3</th> <th>b2</th> <th>b1</th> <th>b0</th> </tr> </thead> <tbody> <tr> <td>SW0130</td> <td>16</td> <td>15</td> <td>14</td> <td>13</td> <td>12</td> <td>11</td> <td>10</td> <td>9</td> <td>8</td> <td>7</td> <td>6</td> <td>5</td> <td>4</td> <td>3</td> <td>2</td> <td>1</td> </tr> <tr> <td>SW0131</td> <td>32</td> <td>31</td> <td>30</td> <td>29</td> <td>28</td> <td>27</td> <td>26</td> <td>25</td> <td>24</td> <td>23</td> <td>22</td> <td>21</td> <td>20</td> <td>19</td> <td>18</td> <td>17</td> </tr> <tr> <td>SW0132</td> <td>48</td> <td>47</td> <td>46</td> <td>45</td> <td>44</td> <td>43</td> <td>42</td> <td>41</td> <td>40</td> <td>39</td> <td>38</td> <td>37</td> <td>36</td> <td>35</td> <td>34</td> <td>33</td> </tr> <tr> <td>SW0133</td> <td>64</td> <td>63</td> <td>62</td> <td>61</td> <td>60</td> <td>59</td> <td>58</td> <td>57</td> <td>56</td> <td>55</td> <td>54</td> <td>53</td> <td>52</td> <td>51</td> <td>50</td> <td>49</td> </tr> <tr> <td>SW0134</td> <td>80</td> <td>79</td> <td>78</td> <td>77</td> <td>76</td> <td>75</td> <td>74</td> <td>73</td> <td>72</td> <td>71</td> <td>70</td> <td>69</td> <td>68</td> <td>67</td> <td>66</td> <td>65</td> </tr> <tr> <td>SW0135</td> <td>96</td> <td>95</td> <td>94</td> <td>93</td> <td>92</td> <td>91</td> <td>90</td> <td>89</td> <td>88</td> <td>87</td> <td>86</td> <td>85</td> <td>84</td> <td>83</td> <td>82</td> <td>81</td> </tr> <tr> <td>SW0136</td> <td>112</td> <td>111</td> <td>110</td> <td>109</td> <td>108</td> <td>107</td> <td>106</td> <td>105</td> <td>104</td> <td>103</td> <td>102</td> <td>101</td> <td>100</td> <td>99</td> <td>98</td> <td>97</td> </tr> <tr> <td>SW0137</td> <td>—</td> <td>—</td> <td>—</td> <td>—</td> <td>—</td> <td>—</td> <td>—</td> <td>—</td> <td>120</td> <td>119</td> <td>118</td> <td>117</td> <td>116</td> <td>115</td> <td>114</td> <td>113</td> </tr> </tbody> </table> <p>Each number in the table represents a station No. — is fixed to 0.</p> <p>(Conditions)</p> <ul style="list-style-type: none"> <li>• This is enabled when the Baton pass status (own station) (SB0047) is OFF.</li> <li>• Holds the data immediately before the error.</li> <li>• This is enabled only for normal stations in the Baton pass status (each station) (SW00A0 to SW00A7).</li> </ul>		b15	b14	b13	b12	b11	b10	b9	b8	b7	b6	b5	b4	b3	b2	b1	b0	SW0130	16	15	14	13	12	11	10	9	8	7	6	5	4	3	2	1	SW0131	32	31	30	29	28	27	26	25	24	23	22	21	20	19	18	17	SW0132	48	47	46	45	44	43	42	41	40	39	38	37	36	35	34	33	SW0133	64	63	62	61	60	59	58	57	56	55	54	53	52	51	50	49	SW0134	80	79	78	77	76	75	74	73	72	71	70	69	68	67	66	65	SW0135	96	95	94	93	92	91	90	89	88	87	86	85	84	83	82	81	SW0136	112	111	110	109	108	107	106	105	104	103	102	101	100	99	98	97	SW0137	—	—	—	—	—	—	—	—	120	119	118	117	116	115	114	113	○	○
	b15	b14	b13	b12	b11	b10	b9	b8	b7	b6	b5	b4	b3	b2	b1	b0																																																																																																																																													
SW0130	16	15	14	13	12	11	10	9	8	7	6	5	4	3	2	1																																																																																																																																													
SW0131	32	31	30	29	28	27	26	25	24	23	22	21	20	19	18	17																																																																																																																																													
SW0132	48	47	46	45	44	43	42	41	40	39	38	37	36	35	34	33																																																																																																																																													
SW0133	64	63	62	61	60	59	58	57	56	55	54	53	52	51	50	49																																																																																																																																													
SW0134	80	79	78	77	76	75	74	73	72	71	70	69	68	67	66	65																																																																																																																																													
SW0135	96	95	94	93	92	91	90	89	88	87	86	85	84	83	82	81																																																																																																																																													
SW0136	112	111	110	109	108	107	106	105	104	103	102	101	100	99	98	97																																																																																																																																													
SW0137	—	—	—	—	—	—	—	—	120	119	118	117	116	115	114	113																																																																																																																																													



Number	Name	Description	Availability																																																																																																																																																										
			Master station	Local station																																																																																																																																																									
SW0138 to SW013F	PORT2 current error frame reception status (each station) (2)	<p>Stores the station number where a receive frame error line status warning level has occurred in each station's PORT2.</p> <ul style="list-style-type: none"> <li>• 0: A receive frame error line status warning level has not yet been occurred in each station's PORT2.</li> <li>• 1: A receive frame error line status warning level has been occurred in each station's PORT2.</li> </ul> <p>When Clear communication error count (SB0006) is turned ON, the stored status is cleared.</p> <table border="1"> <thead> <tr> <th></th> <th>b15</th> <th>b14</th> <th>b13</th> <th>b12</th> <th>b11</th> <th>b10</th> <th>b9</th> <th>b8</th> <th>b7</th> <th>b6</th> <th>b5</th> <th>b4</th> <th>b3</th> <th>b2</th> <th>b1</th> <th>b0</th> </tr> </thead> <tbody> <tr> <td>SW0138</td> <td>16</td> <td>15</td> <td>14</td> <td>13</td> <td>12</td> <td>11</td> <td>10</td> <td>9</td> <td>8</td> <td>7</td> <td>6</td> <td>5</td> <td>4</td> <td>3</td> <td>2</td> <td>1</td> </tr> <tr> <td>SW0139</td> <td>32</td> <td>31</td> <td>30</td> <td>29</td> <td>28</td> <td>27</td> <td>26</td> <td>25</td> <td>24</td> <td>23</td> <td>22</td> <td>21</td> <td>20</td> <td>19</td> <td>18</td> <td>17</td> </tr> <tr> <td>SW013A</td> <td>48</td> <td>47</td> <td>46</td> <td>45</td> <td>44</td> <td>43</td> <td>42</td> <td>41</td> <td>40</td> <td>39</td> <td>38</td> <td>37</td> <td>36</td> <td>35</td> <td>34</td> <td>33</td> </tr> <tr> <td>SW013B</td> <td>64</td> <td>63</td> <td>62</td> <td>61</td> <td>60</td> <td>59</td> <td>58</td> <td>57</td> <td>56</td> <td>55</td> <td>54</td> <td>53</td> <td>52</td> <td>51</td> <td>50</td> <td>49</td> </tr> <tr> <td>SW013C</td> <td>80</td> <td>79</td> <td>78</td> <td>77</td> <td>76</td> <td>75</td> <td>74</td> <td>73</td> <td>72</td> <td>71</td> <td>70</td> <td>69</td> <td>68</td> <td>67</td> <td>66</td> <td>65</td> </tr> <tr> <td>SW013D</td> <td>96</td> <td>95</td> <td>94</td> <td>93</td> <td>92</td> <td>91</td> <td>90</td> <td>89</td> <td>88</td> <td>87</td> <td>86</td> <td>85</td> <td>84</td> <td>83</td> <td>82</td> <td>81</td> </tr> <tr> <td>SW013E</td> <td>112</td> <td>111</td> <td>110</td> <td>109</td> <td>108</td> <td>107</td> <td>106</td> <td>105</td> <td>104</td> <td>103</td> <td>102</td> <td>101</td> <td>100</td> <td>99</td> <td>98</td> <td>97</td> </tr> <tr> <td>SW013F</td> <td>—</td> <td>—</td> <td>—</td> <td>—</td> <td>—</td> <td>—</td> <td>—</td> <td>—</td> <td>120</td> <td>119</td> <td>118</td> <td>117</td> <td>116</td> <td>115</td> <td>114</td> <td>113</td> </tr> </tbody> </table> <p>Each number in the table represents a station No. — is fixed to 0.</p> <p>(Conditions)</p> <ul style="list-style-type: none"> <li>• This is enabled when the Baton pass status (own station) (SB0047) is OFF.</li> <li>• Holds the data immediately before the error.</li> <li>• This is enabled only for normal stations in the Baton pass status (each station) (SW00A0 to SW00A7).</li> </ul>		b15	b14	b13	b12	b11	b10	b9	b8	b7	b6	b5	b4	b3	b2	b1	b0	SW0138	16	15	14	13	12	11	10	9	8	7	6	5	4	3	2	1	SW0139	32	31	30	29	28	27	26	25	24	23	22	21	20	19	18	17	SW013A	48	47	46	45	44	43	42	41	40	39	38	37	36	35	34	33	SW013B	64	63	62	61	60	59	58	57	56	55	54	53	52	51	50	49	SW013C	80	79	78	77	76	75	74	73	72	71	70	69	68	67	66	65	SW013D	96	95	94	93	92	91	90	89	88	87	86	85	84	83	82	81	SW013E	112	111	110	109	108	107	106	105	104	103	102	101	100	99	98	97	SW013F	—	—	—	—	—	—	—	—	120	119	118	117	116	115	114	113	○	○
	b15	b14	b13	b12	b11	b10	b9	b8	b7	b6	b5	b4	b3	b2	b1	b0																																																																																																																																													
SW0138	16	15	14	13	12	11	10	9	8	7	6	5	4	3	2	1																																																																																																																																													
SW0139	32	31	30	29	28	27	26	25	24	23	22	21	20	19	18	17																																																																																																																																													
SW013A	48	47	46	45	44	43	42	41	40	39	38	37	36	35	34	33																																																																																																																																													
SW013B	64	63	62	61	60	59	58	57	56	55	54	53	52	51	50	49																																																																																																																																													
SW013C	80	79	78	77	76	75	74	73	72	71	70	69	68	67	66	65																																																																																																																																													
SW013D	96	95	94	93	92	91	90	89	88	87	86	85	84	83	82	81																																																																																																																																													
SW013E	112	111	110	109	108	107	106	105	104	103	102	101	100	99	98	97																																																																																																																																													
SW013F	—	—	—	—	—	—	—	—	120	119	118	117	116	115	114	113																																																																																																																																													
SW0140 to SW0147	PORT1 error frame reception detection status (1)	<p>Stores the station number where a receive frame error line status caution level has occurred in each station's PORT1 from power-on until the present.</p> <ul style="list-style-type: none"> <li>• 0: A receive frame error line status caution level has not yet been occurred in each station's PORT1.</li> <li>• 1: A receive frame error line status caution level has been occurred in each station's PORT1.</li> </ul> <p>When Clear communication error count (SB0006) is turned ON, the stored status is cleared.</p> <table border="1"> <thead> <tr> <th></th> <th>b15</th> <th>b14</th> <th>b13</th> <th>b12</th> <th>b11</th> <th>b10</th> <th>b9</th> <th>b8</th> <th>b7</th> <th>b6</th> <th>b5</th> <th>b4</th> <th>b3</th> <th>b2</th> <th>b1</th> <th>b0</th> </tr> </thead> <tbody> <tr> <td>SW0140</td> <td>16</td> <td>15</td> <td>14</td> <td>13</td> <td>12</td> <td>11</td> <td>10</td> <td>9</td> <td>8</td> <td>7</td> <td>6</td> <td>5</td> <td>4</td> <td>3</td> <td>2</td> <td>1</td> </tr> <tr> <td>SW0141</td> <td>32</td> <td>31</td> <td>30</td> <td>29</td> <td>28</td> <td>27</td> <td>26</td> <td>25</td> <td>24</td> <td>23</td> <td>22</td> <td>21</td> <td>20</td> <td>19</td> <td>18</td> <td>17</td> </tr> <tr> <td>SW0142</td> <td>48</td> <td>47</td> <td>46</td> <td>45</td> <td>44</td> <td>43</td> <td>42</td> <td>41</td> <td>40</td> <td>39</td> <td>38</td> <td>37</td> <td>36</td> <td>35</td> <td>34</td> <td>33</td> </tr> <tr> <td>SW0143</td> <td>64</td> <td>63</td> <td>62</td> <td>61</td> <td>60</td> <td>59</td> <td>58</td> <td>57</td> <td>56</td> <td>55</td> <td>54</td> <td>53</td> <td>52</td> <td>51</td> <td>50</td> <td>49</td> </tr> <tr> <td>SW0144</td> <td>80</td> <td>79</td> <td>78</td> <td>77</td> <td>76</td> <td>75</td> <td>74</td> <td>73</td> <td>72</td> <td>71</td> <td>70</td> <td>69</td> <td>68</td> <td>67</td> <td>66</td> <td>65</td> </tr> <tr> <td>SW0145</td> <td>96</td> <td>95</td> <td>94</td> <td>93</td> <td>92</td> <td>91</td> <td>90</td> <td>89</td> <td>88</td> <td>87</td> <td>86</td> <td>85</td> <td>84</td> <td>83</td> <td>82</td> <td>81</td> </tr> <tr> <td>SW0146</td> <td>112</td> <td>111</td> <td>110</td> <td>109</td> <td>108</td> <td>107</td> <td>106</td> <td>105</td> <td>104</td> <td>103</td> <td>102</td> <td>101</td> <td>100</td> <td>99</td> <td>98</td> <td>97</td> </tr> <tr> <td>SW0147</td> <td>—</td> <td>—</td> <td>—</td> <td>—</td> <td>—</td> <td>—</td> <td>—</td> <td>—</td> <td>120</td> <td>119</td> <td>118</td> <td>117</td> <td>116</td> <td>115</td> <td>114</td> <td>113</td> </tr> </tbody> </table> <p>Each number in the table represents a station No. — is fixed to 0.</p> <p>(Conditions)</p> <ul style="list-style-type: none"> <li>• This is enabled when the Baton pass status (own station) (SB0047) is OFF.</li> <li>• Holds the data immediately before the error.</li> <li>• This is enabled only for normal stations in the Baton pass status (each station) (SW00A0 to SW00A7).</li> </ul>		b15	b14	b13	b12	b11	b10	b9	b8	b7	b6	b5	b4	b3	b2	b1	b0	SW0140	16	15	14	13	12	11	10	9	8	7	6	5	4	3	2	1	SW0141	32	31	30	29	28	27	26	25	24	23	22	21	20	19	18	17	SW0142	48	47	46	45	44	43	42	41	40	39	38	37	36	35	34	33	SW0143	64	63	62	61	60	59	58	57	56	55	54	53	52	51	50	49	SW0144	80	79	78	77	76	75	74	73	72	71	70	69	68	67	66	65	SW0145	96	95	94	93	92	91	90	89	88	87	86	85	84	83	82	81	SW0146	112	111	110	109	108	107	106	105	104	103	102	101	100	99	98	97	SW0147	—	—	—	—	—	—	—	—	120	119	118	117	116	115	114	113	○	○
	b15	b14	b13	b12	b11	b10	b9	b8	b7	b6	b5	b4	b3	b2	b1	b0																																																																																																																																													
SW0140	16	15	14	13	12	11	10	9	8	7	6	5	4	3	2	1																																																																																																																																													
SW0141	32	31	30	29	28	27	26	25	24	23	22	21	20	19	18	17																																																																																																																																													
SW0142	48	47	46	45	44	43	42	41	40	39	38	37	36	35	34	33																																																																																																																																													
SW0143	64	63	62	61	60	59	58	57	56	55	54	53	52	51	50	49																																																																																																																																													
SW0144	80	79	78	77	76	75	74	73	72	71	70	69	68	67	66	65																																																																																																																																													
SW0145	96	95	94	93	92	91	90	89	88	87	86	85	84	83	82	81																																																																																																																																													
SW0146	112	111	110	109	108	107	106	105	104	103	102	101	100	99	98	97																																																																																																																																													
SW0147	—	—	—	—	—	—	—	—	120	119	118	117	116	115	114	113																																																																																																																																													

Number	Name	Description	Availability																																																																																																																																																										
			Master station	Local station																																																																																																																																																									
SW0148 to SW014F	PORT1 error frame reception detection status (2)	<p>Stores the station number where a receive frame error line status warning level has occurred in each station's PORT1 from power-on until the present.</p> <ul style="list-style-type: none"> <li>• 0: A receive frame error line status warning level has not yet been occurred in each station's PORT1.</li> <li>• 1: A receive frame error line status warning level has been occurred in each station's PORT1.</li> </ul> <p>When Clear communication error count (SB0006) is turned ON, the stored status is cleared.</p> <table border="1"> <thead> <tr> <th></th> <th>b15</th> <th>b14</th> <th>b13</th> <th>b12</th> <th>b11</th> <th>b10</th> <th>b9</th> <th>b8</th> <th>b7</th> <th>b6</th> <th>b5</th> <th>b4</th> <th>b3</th> <th>b2</th> <th>b1</th> <th>b0</th> </tr> </thead> <tbody> <tr> <td>SW0148</td> <td>16</td> <td>15</td> <td>14</td> <td>13</td> <td>12</td> <td>11</td> <td>10</td> <td>9</td> <td>8</td> <td>7</td> <td>6</td> <td>5</td> <td>4</td> <td>3</td> <td>2</td> <td>1</td> </tr> <tr> <td>SW0149</td> <td>32</td> <td>31</td> <td>30</td> <td>29</td> <td>28</td> <td>27</td> <td>26</td> <td>25</td> <td>24</td> <td>23</td> <td>22</td> <td>21</td> <td>20</td> <td>19</td> <td>18</td> <td>17</td> </tr> <tr> <td>SW014A</td> <td>48</td> <td>47</td> <td>46</td> <td>45</td> <td>44</td> <td>43</td> <td>42</td> <td>41</td> <td>40</td> <td>39</td> <td>38</td> <td>37</td> <td>36</td> <td>35</td> <td>34</td> <td>33</td> </tr> <tr> <td>SW014B</td> <td>64</td> <td>63</td> <td>62</td> <td>61</td> <td>60</td> <td>59</td> <td>58</td> <td>57</td> <td>56</td> <td>55</td> <td>54</td> <td>53</td> <td>52</td> <td>51</td> <td>50</td> <td>49</td> </tr> <tr> <td>SW014C</td> <td>80</td> <td>79</td> <td>78</td> <td>77</td> <td>76</td> <td>75</td> <td>74</td> <td>73</td> <td>72</td> <td>71</td> <td>70</td> <td>69</td> <td>68</td> <td>67</td> <td>66</td> <td>65</td> </tr> <tr> <td>SW014D</td> <td>96</td> <td>95</td> <td>94</td> <td>93</td> <td>92</td> <td>91</td> <td>90</td> <td>89</td> <td>88</td> <td>87</td> <td>86</td> <td>85</td> <td>84</td> <td>83</td> <td>82</td> <td>81</td> </tr> <tr> <td>SW014E</td> <td>112</td> <td>111</td> <td>110</td> <td>109</td> <td>108</td> <td>107</td> <td>106</td> <td>105</td> <td>104</td> <td>103</td> <td>102</td> <td>101</td> <td>100</td> <td>99</td> <td>98</td> <td>97</td> </tr> <tr> <td>SW014F</td> <td>—</td> <td>—</td> <td>—</td> <td>—</td> <td>—</td> <td>—</td> <td>—</td> <td>—</td> <td>120</td> <td>119</td> <td>118</td> <td>117</td> <td>116</td> <td>115</td> <td>114</td> <td>113</td> </tr> </tbody> </table> <p>Each number in the table represents a station No. — is fixed to 0.</p> <p>(Conditions)</p> <ul style="list-style-type: none"> <li>• This is enabled when the Baton pass status (own station) (SB0047) is OFF.</li> <li>• Holds the data immediately before the error.</li> <li>• This is enabled only for normal stations in the Baton pass status (each station) (SW00A0 to SW00A7).</li> </ul>		b15	b14	b13	b12	b11	b10	b9	b8	b7	b6	b5	b4	b3	b2	b1	b0	SW0148	16	15	14	13	12	11	10	9	8	7	6	5	4	3	2	1	SW0149	32	31	30	29	28	27	26	25	24	23	22	21	20	19	18	17	SW014A	48	47	46	45	44	43	42	41	40	39	38	37	36	35	34	33	SW014B	64	63	62	61	60	59	58	57	56	55	54	53	52	51	50	49	SW014C	80	79	78	77	76	75	74	73	72	71	70	69	68	67	66	65	SW014D	96	95	94	93	92	91	90	89	88	87	86	85	84	83	82	81	SW014E	112	111	110	109	108	107	106	105	104	103	102	101	100	99	98	97	SW014F	—	—	—	—	—	—	—	—	120	119	118	117	116	115	114	113	○	○
	b15	b14	b13	b12	b11	b10	b9	b8	b7	b6	b5	b4	b3	b2	b1	b0																																																																																																																																													
SW0148	16	15	14	13	12	11	10	9	8	7	6	5	4	3	2	1																																																																																																																																													
SW0149	32	31	30	29	28	27	26	25	24	23	22	21	20	19	18	17																																																																																																																																													
SW014A	48	47	46	45	44	43	42	41	40	39	38	37	36	35	34	33																																																																																																																																													
SW014B	64	63	62	61	60	59	58	57	56	55	54	53	52	51	50	49																																																																																																																																													
SW014C	80	79	78	77	76	75	74	73	72	71	70	69	68	67	66	65																																																																																																																																													
SW014D	96	95	94	93	92	91	90	89	88	87	86	85	84	83	82	81																																																																																																																																													
SW014E	112	111	110	109	108	107	106	105	104	103	102	101	100	99	98	97																																																																																																																																													
SW014F	—	—	—	—	—	—	—	—	120	119	118	117	116	115	114	113																																																																																																																																													
SW0150 to SW0157	PORT2 error frame reception detection status (1)	<p>Stores the station number where a receive frame error line status caution level has occurred in each station's PORT2 from power-on until the present.</p> <ul style="list-style-type: none"> <li>• 0: A receive frame error line status caution level has not yet been occurred in each station's PORT2.</li> <li>• 1: A receive frame error line status caution level has been occurred in each station's PORT2.</li> </ul> <p>When Clear communication error count (SB0006) is turned ON, the stored status is cleared.</p> <table border="1"> <thead> <tr> <th></th> <th>b15</th> <th>b14</th> <th>b13</th> <th>b12</th> <th>b11</th> <th>b10</th> <th>b9</th> <th>b8</th> <th>b7</th> <th>b6</th> <th>b5</th> <th>b4</th> <th>b3</th> <th>b2</th> <th>b1</th> <th>b0</th> </tr> </thead> <tbody> <tr> <td>SW0150</td> <td>16</td> <td>15</td> <td>14</td> <td>13</td> <td>12</td> <td>11</td> <td>10</td> <td>9</td> <td>8</td> <td>7</td> <td>6</td> <td>5</td> <td>4</td> <td>3</td> <td>2</td> <td>1</td> </tr> <tr> <td>SW0151</td> <td>32</td> <td>31</td> <td>30</td> <td>29</td> <td>28</td> <td>27</td> <td>26</td> <td>25</td> <td>24</td> <td>23</td> <td>22</td> <td>21</td> <td>20</td> <td>19</td> <td>18</td> <td>17</td> </tr> <tr> <td>SW0152</td> <td>48</td> <td>47</td> <td>46</td> <td>45</td> <td>44</td> <td>43</td> <td>42</td> <td>41</td> <td>40</td> <td>39</td> <td>38</td> <td>37</td> <td>36</td> <td>35</td> <td>34</td> <td>33</td> </tr> <tr> <td>SW0153</td> <td>64</td> <td>63</td> <td>62</td> <td>61</td> <td>60</td> <td>59</td> <td>58</td> <td>57</td> <td>56</td> <td>55</td> <td>54</td> <td>53</td> <td>52</td> <td>51</td> <td>50</td> <td>49</td> </tr> <tr> <td>SW0154</td> <td>80</td> <td>79</td> <td>78</td> <td>77</td> <td>76</td> <td>75</td> <td>74</td> <td>73</td> <td>72</td> <td>71</td> <td>70</td> <td>69</td> <td>68</td> <td>67</td> <td>66</td> <td>65</td> </tr> <tr> <td>SW0155</td> <td>96</td> <td>95</td> <td>94</td> <td>93</td> <td>92</td> <td>91</td> <td>90</td> <td>89</td> <td>88</td> <td>87</td> <td>86</td> <td>85</td> <td>84</td> <td>83</td> <td>82</td> <td>81</td> </tr> <tr> <td>SW0156</td> <td>112</td> <td>111</td> <td>110</td> <td>109</td> <td>108</td> <td>107</td> <td>106</td> <td>105</td> <td>104</td> <td>103</td> <td>102</td> <td>101</td> <td>100</td> <td>99</td> <td>98</td> <td>97</td> </tr> <tr> <td>SW0157</td> <td>—</td> <td>—</td> <td>—</td> <td>—</td> <td>—</td> <td>—</td> <td>—</td> <td>—</td> <td>120</td> <td>119</td> <td>118</td> <td>117</td> <td>116</td> <td>115</td> <td>114</td> <td>113</td> </tr> </tbody> </table> <p>Each number in the table represents a station No. — is fixed to 0.</p> <p>(Conditions)</p> <ul style="list-style-type: none"> <li>• This is enabled when the Baton pass status (own station) (SB0047) is OFF.</li> <li>• Holds the data immediately before the error.</li> <li>• This is enabled only for normal stations in the Baton pass status (each station) (SW00A0 to SW00A7).</li> </ul>		b15	b14	b13	b12	b11	b10	b9	b8	b7	b6	b5	b4	b3	b2	b1	b0	SW0150	16	15	14	13	12	11	10	9	8	7	6	5	4	3	2	1	SW0151	32	31	30	29	28	27	26	25	24	23	22	21	20	19	18	17	SW0152	48	47	46	45	44	43	42	41	40	39	38	37	36	35	34	33	SW0153	64	63	62	61	60	59	58	57	56	55	54	53	52	51	50	49	SW0154	80	79	78	77	76	75	74	73	72	71	70	69	68	67	66	65	SW0155	96	95	94	93	92	91	90	89	88	87	86	85	84	83	82	81	SW0156	112	111	110	109	108	107	106	105	104	103	102	101	100	99	98	97	SW0157	—	—	—	—	—	—	—	—	120	119	118	117	116	115	114	113	○	○
	b15	b14	b13	b12	b11	b10	b9	b8	b7	b6	b5	b4	b3	b2	b1	b0																																																																																																																																													
SW0150	16	15	14	13	12	11	10	9	8	7	6	5	4	3	2	1																																																																																																																																													
SW0151	32	31	30	29	28	27	26	25	24	23	22	21	20	19	18	17																																																																																																																																													
SW0152	48	47	46	45	44	43	42	41	40	39	38	37	36	35	34	33																																																																																																																																													
SW0153	64	63	62	61	60	59	58	57	56	55	54	53	52	51	50	49																																																																																																																																													
SW0154	80	79	78	77	76	75	74	73	72	71	70	69	68	67	66	65																																																																																																																																													
SW0155	96	95	94	93	92	91	90	89	88	87	86	85	84	83	82	81																																																																																																																																													
SW0156	112	111	110	109	108	107	106	105	104	103	102	101	100	99	98	97																																																																																																																																													
SW0157	—	—	—	—	—	—	—	—	120	119	118	117	116	115	114	113																																																																																																																																													



Number	Name	Description	Availability																																																																																																																																																										
			Master station	Local station																																																																																																																																																									
SW0158 to SW015F	PORT2 error frame reception detection status (2)	<p>Stores the station number where a receive frame error line status warning level has occurred in each station's PORT2 from power-on until the present.</p> <ul style="list-style-type: none"> <li>• 0: A receive frame error line status warning level has not yet been occurred in each station's PORT2.</li> <li>• 1: A receive frame error line status warning level has been occurred in each station's PORT2.</li> </ul> <p>When Clear communication error count (SB0006) is turned ON, the stored status is cleared.</p> <table border="1"> <thead> <tr> <th></th> <th>b15</th> <th>b14</th> <th>b13</th> <th>b12</th> <th>b11</th> <th>b10</th> <th>b9</th> <th>b8</th> <th>b7</th> <th>b6</th> <th>b5</th> <th>b4</th> <th>b3</th> <th>b2</th> <th>b1</th> <th>b0</th> </tr> </thead> <tbody> <tr> <td>SW0158</td> <td>16</td> <td>15</td> <td>14</td> <td>13</td> <td>12</td> <td>11</td> <td>10</td> <td>9</td> <td>8</td> <td>7</td> <td>6</td> <td>5</td> <td>4</td> <td>3</td> <td>2</td> <td>1</td> </tr> <tr> <td>SW0159</td> <td>32</td> <td>31</td> <td>30</td> <td>29</td> <td>28</td> <td>27</td> <td>26</td> <td>25</td> <td>24</td> <td>23</td> <td>22</td> <td>21</td> <td>20</td> <td>19</td> <td>18</td> <td>17</td> </tr> <tr> <td>SW015A</td> <td>48</td> <td>47</td> <td>46</td> <td>45</td> <td>44</td> <td>43</td> <td>42</td> <td>41</td> <td>40</td> <td>39</td> <td>38</td> <td>37</td> <td>36</td> <td>35</td> <td>34</td> <td>33</td> </tr> <tr> <td>SW015B</td> <td>64</td> <td>63</td> <td>62</td> <td>61</td> <td>60</td> <td>59</td> <td>58</td> <td>57</td> <td>56</td> <td>55</td> <td>54</td> <td>53</td> <td>52</td> <td>51</td> <td>50</td> <td>49</td> </tr> <tr> <td>SW015C</td> <td>80</td> <td>79</td> <td>78</td> <td>77</td> <td>76</td> <td>75</td> <td>74</td> <td>73</td> <td>72</td> <td>71</td> <td>70</td> <td>69</td> <td>68</td> <td>67</td> <td>66</td> <td>65</td> </tr> <tr> <td>SW015D</td> <td>96</td> <td>95</td> <td>94</td> <td>93</td> <td>92</td> <td>91</td> <td>90</td> <td>89</td> <td>88</td> <td>87</td> <td>86</td> <td>85</td> <td>84</td> <td>83</td> <td>82</td> <td>81</td> </tr> <tr> <td>SW015E</td> <td>112</td> <td>111</td> <td>110</td> <td>109</td> <td>108</td> <td>107</td> <td>106</td> <td>105</td> <td>104</td> <td>103</td> <td>102</td> <td>101</td> <td>100</td> <td>99</td> <td>98</td> <td>97</td> </tr> <tr> <td>SW015F</td> <td>—</td> <td>—</td> <td>—</td> <td>—</td> <td>—</td> <td>—</td> <td>—</td> <td>—</td> <td>120</td> <td>119</td> <td>118</td> <td>117</td> <td>116</td> <td>115</td> <td>114</td> <td>113</td> </tr> </tbody> </table> <p>Each number in the table represents a station No. — is fixed to 0.</p> <p>(Conditions)</p> <ul style="list-style-type: none"> <li>• This is enabled when the Baton pass status (own station) (SB0047) is OFF.</li> <li>• Holds the data immediately before the error.</li> <li>• This is enabled only for normal stations in the Baton pass status (each station) (SW00A0 to SW00A7).</li> </ul>		b15	b14	b13	b12	b11	b10	b9	b8	b7	b6	b5	b4	b3	b2	b1	b0	SW0158	16	15	14	13	12	11	10	9	8	7	6	5	4	3	2	1	SW0159	32	31	30	29	28	27	26	25	24	23	22	21	20	19	18	17	SW015A	48	47	46	45	44	43	42	41	40	39	38	37	36	35	34	33	SW015B	64	63	62	61	60	59	58	57	56	55	54	53	52	51	50	49	SW015C	80	79	78	77	76	75	74	73	72	71	70	69	68	67	66	65	SW015D	96	95	94	93	92	91	90	89	88	87	86	85	84	83	82	81	SW015E	112	111	110	109	108	107	106	105	104	103	102	101	100	99	98	97	SW015F	—	—	—	—	—	—	—	—	120	119	118	117	116	115	114	113	<input type="radio"/>	<input type="radio"/>
	b15	b14	b13	b12	b11	b10	b9	b8	b7	b6	b5	b4	b3	b2	b1	b0																																																																																																																																													
SW0158	16	15	14	13	12	11	10	9	8	7	6	5	4	3	2	1																																																																																																																																													
SW0159	32	31	30	29	28	27	26	25	24	23	22	21	20	19	18	17																																																																																																																																													
SW015A	48	47	46	45	44	43	42	41	40	39	38	37	36	35	34	33																																																																																																																																													
SW015B	64	63	62	61	60	59	58	57	56	55	54	53	52	51	50	49																																																																																																																																													
SW015C	80	79	78	77	76	75	74	73	72	71	70	69	68	67	66	65																																																																																																																																													
SW015D	96	95	94	93	92	91	90	89	88	87	86	85	84	83	82	81																																																																																																																																													
SW015E	112	111	110	109	108	107	106	105	104	103	102	101	100	99	98	97																																																																																																																																													
SW015F	—	—	—	—	—	—	—	—	120	119	118	117	116	115	114	113																																																																																																																																													
SW0170 to SW0177	Parameter error status (each station)	<p>Stores the parameter status for each station.</p> <ul style="list-style-type: none"> <li>• 0: No parameter error</li> <li>• 1: Parameter error found</li> </ul> <table border="1"> <thead> <tr> <th></th> <th>b15</th> <th>b14</th> <th>b13</th> <th>b12</th> <th>b11</th> <th>b10</th> <th>b9</th> <th>b8</th> <th>b7</th> <th>b6</th> <th>b5</th> <th>b4</th> <th>b3</th> <th>b2</th> <th>b1</th> <th>b0</th> </tr> </thead> <tbody> <tr> <td>SW0170</td> <td>16</td> <td>15</td> <td>14</td> <td>13</td> <td>12</td> <td>11</td> <td>10</td> <td>9</td> <td>8</td> <td>7</td> <td>6</td> <td>5</td> <td>4</td> <td>3</td> <td>2</td> <td>1</td> </tr> <tr> <td>SW0171</td> <td>32</td> <td>31</td> <td>30</td> <td>29</td> <td>28</td> <td>27</td> <td>26</td> <td>25</td> <td>24</td> <td>23</td> <td>22</td> <td>21</td> <td>20</td> <td>19</td> <td>18</td> <td>17</td> </tr> <tr> <td>SW0172</td> <td>48</td> <td>47</td> <td>46</td> <td>45</td> <td>44</td> <td>43</td> <td>42</td> <td>41</td> <td>40</td> <td>39</td> <td>38</td> <td>37</td> <td>36</td> <td>35</td> <td>34</td> <td>33</td> </tr> <tr> <td>SW0173</td> <td>64</td> <td>63</td> <td>62</td> <td>61</td> <td>60</td> <td>59</td> <td>58</td> <td>57</td> <td>56</td> <td>55</td> <td>54</td> <td>53</td> <td>52</td> <td>51</td> <td>50</td> <td>49</td> </tr> <tr> <td>SW0174</td> <td>80</td> <td>79</td> <td>78</td> <td>77</td> <td>76</td> <td>75</td> <td>74</td> <td>73</td> <td>72</td> <td>71</td> <td>70</td> <td>69</td> <td>68</td> <td>67</td> <td>66</td> <td>65</td> </tr> <tr> <td>SW0175</td> <td>96</td> <td>95</td> <td>94</td> <td>93</td> <td>92</td> <td>91</td> <td>90</td> <td>89</td> <td>88</td> <td>87</td> <td>86</td> <td>85</td> <td>84</td> <td>83</td> <td>82</td> <td>81</td> </tr> <tr> <td>SW0176</td> <td>112</td> <td>111</td> <td>110</td> <td>109</td> <td>108</td> <td>107</td> <td>106</td> <td>105</td> <td>104</td> <td>103</td> <td>102</td> <td>101</td> <td>100</td> <td>99</td> <td>98</td> <td>97</td> </tr> <tr> <td>SW0177</td> <td>—</td> <td>—</td> <td>—</td> <td>—</td> <td>—</td> <td>—</td> <td>—</td> <td>—</td> <td>120</td> <td>119</td> <td>118</td> <td>117</td> <td>116</td> <td>115</td> <td>114</td> <td>113</td> </tr> </tbody> </table> <p>Each number in the table represents a station No. — is fixed to 0.</p> <p>(Conditions)</p> <ul style="list-style-type: none"> <li>• This is enabled when the Baton pass status (own station) (SB0047) is OFF.</li> <li>• Holds the data immediately before the error.</li> <li>• This is enabled only for normal stations in the Baton pass status (each station) (SW00A0 to SW00A7).</li> <li>• Reserved stations and stations higher than the maximum station number are ignored.</li> </ul>		b15	b14	b13	b12	b11	b10	b9	b8	b7	b6	b5	b4	b3	b2	b1	b0	SW0170	16	15	14	13	12	11	10	9	8	7	6	5	4	3	2	1	SW0171	32	31	30	29	28	27	26	25	24	23	22	21	20	19	18	17	SW0172	48	47	46	45	44	43	42	41	40	39	38	37	36	35	34	33	SW0173	64	63	62	61	60	59	58	57	56	55	54	53	52	51	50	49	SW0174	80	79	78	77	76	75	74	73	72	71	70	69	68	67	66	65	SW0175	96	95	94	93	92	91	90	89	88	87	86	85	84	83	82	81	SW0176	112	111	110	109	108	107	106	105	104	103	102	101	100	99	98	97	SW0177	—	—	—	—	—	—	—	—	120	119	118	117	116	115	114	113	<input type="radio"/>	<input type="radio"/>
	b15	b14	b13	b12	b11	b10	b9	b8	b7	b6	b5	b4	b3	b2	b1	b0																																																																																																																																													
SW0170	16	15	14	13	12	11	10	9	8	7	6	5	4	3	2	1																																																																																																																																													
SW0171	32	31	30	29	28	27	26	25	24	23	22	21	20	19	18	17																																																																																																																																													
SW0172	48	47	46	45	44	43	42	41	40	39	38	37	36	35	34	33																																																																																																																																													
SW0173	64	63	62	61	60	59	58	57	56	55	54	53	52	51	50	49																																																																																																																																													
SW0174	80	79	78	77	76	75	74	73	72	71	70	69	68	67	66	65																																																																																																																																													
SW0175	96	95	94	93	92	91	90	89	88	87	86	85	84	83	82	81																																																																																																																																													
SW0176	112	111	110	109	108	107	106	105	104	103	102	101	100	99	98	97																																																																																																																																													
SW0177	—	—	—	—	—	—	—	—	120	119	118	117	116	115	114	113																																																																																																																																													

Number	Name	Description	Availability																																																																																																																																																										
			Master station	Local station																																																																																																																																																									
SW0180 to SW0187	Reserved station function disable status	<p>Stores the station that is currently in reserved station function disable status.</p> <ul style="list-style-type: none"> <li>• 0: No reserved station function disable is specified</li> <li>• 1: Reserved station function disable in progress</li> </ul> <table border="1"> <thead> <tr> <th></th> <th>b15</th> <th>b14</th> <th>b13</th> <th>b12</th> <th>b11</th> <th>b10</th> <th>b9</th> <th>b8</th> <th>b7</th> <th>b6</th> <th>b5</th> <th>b4</th> <th>b3</th> <th>b2</th> <th>b1</th> <th>b0</th> </tr> </thead> <tbody> <tr> <td>SW0180</td> <td>16</td> <td>15</td> <td>14</td> <td>13</td> <td>12</td> <td>11</td> <td>10</td> <td>9</td> <td>8</td> <td>7</td> <td>6</td> <td>5</td> <td>4</td> <td>3</td> <td>2</td> <td>1</td> </tr> <tr> <td>SW0181</td> <td>32</td> <td>31</td> <td>30</td> <td>29</td> <td>28</td> <td>27</td> <td>26</td> <td>25</td> <td>24</td> <td>23</td> <td>22</td> <td>21</td> <td>20</td> <td>19</td> <td>18</td> <td>17</td> </tr> <tr> <td>SW0182</td> <td>48</td> <td>47</td> <td>46</td> <td>45</td> <td>44</td> <td>43</td> <td>42</td> <td>41</td> <td>40</td> <td>39</td> <td>38</td> <td>37</td> <td>36</td> <td>35</td> <td>34</td> <td>33</td> </tr> <tr> <td>SW0183</td> <td>64</td> <td>63</td> <td>62</td> <td>61</td> <td>60</td> <td>59</td> <td>58</td> <td>57</td> <td>56</td> <td>55</td> <td>54</td> <td>53</td> <td>52</td> <td>51</td> <td>50</td> <td>49</td> </tr> <tr> <td>SW0184</td> <td>80</td> <td>79</td> <td>78</td> <td>77</td> <td>76</td> <td>75</td> <td>74</td> <td>73</td> <td>72</td> <td>71</td> <td>70</td> <td>69</td> <td>68</td> <td>67</td> <td>66</td> <td>65</td> </tr> <tr> <td>SW0185</td> <td>96</td> <td>95</td> <td>94</td> <td>93</td> <td>92</td> <td>91</td> <td>90</td> <td>89</td> <td>88</td> <td>87</td> <td>86</td> <td>85</td> <td>84</td> <td>83</td> <td>82</td> <td>81</td> </tr> <tr> <td>SW0186</td> <td>112</td> <td>111</td> <td>110</td> <td>109</td> <td>108</td> <td>107</td> <td>106</td> <td>105</td> <td>104</td> <td>103</td> <td>102</td> <td>101</td> <td>100</td> <td>99</td> <td>98</td> <td>97</td> </tr> <tr> <td>SW0187</td> <td>—</td> <td>—</td> <td>—</td> <td>—</td> <td>—</td> <td>—</td> <td>—</td> <td>—</td> <td>120</td> <td>119</td> <td>118</td> <td>117</td> <td>116</td> <td>115</td> <td>114</td> <td>113</td> </tr> </tbody> </table> <p>Each number in the table represents a station No. — is fixed to 0.</p> <p>(Conditions)</p> <ul style="list-style-type: none"> <li>• This is enabled when the Baton pass status (own station) (SB0047) is OFF.</li> <li>• Holds the data immediately before the error.</li> <li>• This is enabled only for normal stations in the Baton pass status (each station) (SW00A0 to SW00A7).</li> <li>• Stations higher than the maximum station number are ignored.</li> </ul>		b15	b14	b13	b12	b11	b10	b9	b8	b7	b6	b5	b4	b3	b2	b1	b0	SW0180	16	15	14	13	12	11	10	9	8	7	6	5	4	3	2	1	SW0181	32	31	30	29	28	27	26	25	24	23	22	21	20	19	18	17	SW0182	48	47	46	45	44	43	42	41	40	39	38	37	36	35	34	33	SW0183	64	63	62	61	60	59	58	57	56	55	54	53	52	51	50	49	SW0184	80	79	78	77	76	75	74	73	72	71	70	69	68	67	66	65	SW0185	96	95	94	93	92	91	90	89	88	87	86	85	84	83	82	81	SW0186	112	111	110	109	108	107	106	105	104	103	102	101	100	99	98	97	SW0187	—	—	—	—	—	—	—	—	120	119	118	117	116	115	114	113	○	○
	b15	b14	b13	b12	b11	b10	b9	b8	b7	b6	b5	b4	b3	b2	b1	b0																																																																																																																																													
SW0180	16	15	14	13	12	11	10	9	8	7	6	5	4	3	2	1																																																																																																																																													
SW0181	32	31	30	29	28	27	26	25	24	23	22	21	20	19	18	17																																																																																																																																													
SW0182	48	47	46	45	44	43	42	41	40	39	38	37	36	35	34	33																																																																																																																																													
SW0183	64	63	62	61	60	59	58	57	56	55	54	53	52	51	50	49																																																																																																																																													
SW0184	80	79	78	77	76	75	74	73	72	71	70	69	68	67	66	65																																																																																																																																													
SW0185	96	95	94	93	92	91	90	89	88	87	86	85	84	83	82	81																																																																																																																																													
SW0186	112	111	110	109	108	107	106	105	104	103	102	101	100	99	98	97																																																																																																																																													
SW0187	—	—	—	—	—	—	—	—	120	119	118	117	116	115	114	113																																																																																																																																													
SW0194	Loop test result	<p>Stores a loop test result.</p> <ul style="list-style-type: none"> <li>• 0: Normal completion</li> <li>• Other than 0: Abnormal end (Refer to the figure below.)</li> </ul> <table border="1"> <thead> <tr> <th></th> <th>b15</th> <th>b14</th> <th colspan="2">to</th> <th>b1</th> <th>b0</th> </tr> </thead> <tbody> <tr> <td>SW0914</td> <td></td> <td></td> <td></td> <td></td> <td></td> <td></td> </tr> </tbody> </table> <ul style="list-style-type: none"> <li>• b0: Master station duplicated</li> <li>• b1: Station number duplicated</li> <li>• b2: Invalid station No.</li> <li>• b3: Reserved station specification error</li> </ul> <p>(A station that exists on the network is set as a reserved station in the master station.)</p> <ul style="list-style-type: none"> <li>• b4: All stations faulty</li> <li>• b5: Inconsistent total number of linked stations</li> <li>• b6: Station type setting error</li> <li>• b7: Loopback stations exist.</li> <li>• b8 to b15: Fixed to 0</li> </ul>		b15	b14	to		b1	b0	SW0914							○	×																																																																																																																																											
	b15	b14	to		b1	b0																																																																																																																																																							
SW0914																																																																																																																																																													
SW01A0 to SW01A7	Loop test error station	<p>Stores the execution result of a loop test.</p> <ul style="list-style-type: none"> <li>• 0: Normal</li> <li>• 1: Error</li> </ul> <table border="1"> <thead> <tr> <th></th> <th>b15</th> <th>b14</th> <th>b13</th> <th>b12</th> <th>b11</th> <th>b10</th> <th>b9</th> <th>b8</th> <th>b7</th> <th>b6</th> <th>b5</th> <th>b4</th> <th>b3</th> <th>b2</th> <th>b1</th> <th>b0</th> </tr> </thead> <tbody> <tr> <td>SW01A0</td> <td>16</td> <td>15</td> <td>14</td> <td>13</td> <td>12</td> <td>11</td> <td>10</td> <td>9</td> <td>8</td> <td>7</td> <td>6</td> <td>5</td> <td>4</td> <td>3</td> <td>2</td> <td>1</td> </tr> <tr> <td>SW01A1</td> <td>32</td> <td>31</td> <td>30</td> <td>29</td> <td>28</td> <td>27</td> <td>26</td> <td>25</td> <td>24</td> <td>23</td> <td>22</td> <td>21</td> <td>20</td> <td>19</td> <td>18</td> <td>17</td> </tr> <tr> <td>SW01A2</td> <td>48</td> <td>47</td> <td>46</td> <td>45</td> <td>44</td> <td>43</td> <td>42</td> <td>41</td> <td>40</td> <td>39</td> <td>38</td> <td>37</td> <td>36</td> <td>35</td> <td>34</td> <td>33</td> </tr> <tr> <td>SW01A3</td> <td>64</td> <td>63</td> <td>62</td> <td>61</td> <td>60</td> <td>59</td> <td>58</td> <td>57</td> <td>56</td> <td>55</td> <td>54</td> <td>53</td> <td>52</td> <td>51</td> <td>50</td> <td>49</td> </tr> <tr> <td>SW01A4</td> <td>80</td> <td>79</td> <td>78</td> <td>77</td> <td>76</td> <td>75</td> <td>74</td> <td>73</td> <td>72</td> <td>71</td> <td>70</td> <td>69</td> <td>68</td> <td>67</td> <td>66</td> <td>65</td> </tr> <tr> <td>SW01A5</td> <td>96</td> <td>95</td> <td>94</td> <td>93</td> <td>92</td> <td>91</td> <td>90</td> <td>89</td> <td>88</td> <td>87</td> <td>86</td> <td>85</td> <td>84</td> <td>83</td> <td>82</td> <td>81</td> </tr> <tr> <td>SW01A6</td> <td>112</td> <td>111</td> <td>110</td> <td>109</td> <td>108</td> <td>107</td> <td>106</td> <td>105</td> <td>104</td> <td>103</td> <td>102</td> <td>101</td> <td>100</td> <td>99</td> <td>98</td> <td>97</td> </tr> <tr> <td>SW01A7</td> <td>—</td> <td>—</td> <td>—</td> <td>—</td> <td>—</td> <td>—</td> <td>—</td> <td>—</td> <td>120</td> <td>119</td> <td>118</td> <td>117</td> <td>116</td> <td>115</td> <td>114</td> <td>113</td> </tr> </tbody> </table> <p>Each number in the table represents a station No. — is fixed to 0.</p>		b15	b14	b13	b12	b11	b10	b9	b8	b7	b6	b5	b4	b3	b2	b1	b0	SW01A0	16	15	14	13	12	11	10	9	8	7	6	5	4	3	2	1	SW01A1	32	31	30	29	28	27	26	25	24	23	22	21	20	19	18	17	SW01A2	48	47	46	45	44	43	42	41	40	39	38	37	36	35	34	33	SW01A3	64	63	62	61	60	59	58	57	56	55	54	53	52	51	50	49	SW01A4	80	79	78	77	76	75	74	73	72	71	70	69	68	67	66	65	SW01A5	96	95	94	93	92	91	90	89	88	87	86	85	84	83	82	81	SW01A6	112	111	110	109	108	107	106	105	104	103	102	101	100	99	98	97	SW01A7	—	—	—	—	—	—	—	—	120	119	118	117	116	115	114	113	○	×
	b15	b14	b13	b12	b11	b10	b9	b8	b7	b6	b5	b4	b3	b2	b1	b0																																																																																																																																													
SW01A0	16	15	14	13	12	11	10	9	8	7	6	5	4	3	2	1																																																																																																																																													
SW01A1	32	31	30	29	28	27	26	25	24	23	22	21	20	19	18	17																																																																																																																																													
SW01A2	48	47	46	45	44	43	42	41	40	39	38	37	36	35	34	33																																																																																																																																													
SW01A3	64	63	62	61	60	59	58	57	56	55	54	53	52	51	50	49																																																																																																																																													
SW01A4	80	79	78	77	76	75	74	73	72	71	70	69	68	67	66	65																																																																																																																																													
SW01A5	96	95	94	93	92	91	90	89	88	87	86	85	84	83	82	81																																																																																																																																													
SW01A6	112	111	110	109	108	107	106	105	104	103	102	101	100	99	98	97																																																																																																																																													
SW01A7	—	—	—	—	—	—	—	—	120	119	118	117	116	115	114	113																																																																																																																																													



# Appendix 5 Processing Time

The processing time of the CC-Link IE Field Network consists of the time components below.

Sequence scan + Link refresh time + Link scan time + Device station processing time = Transmission delay time

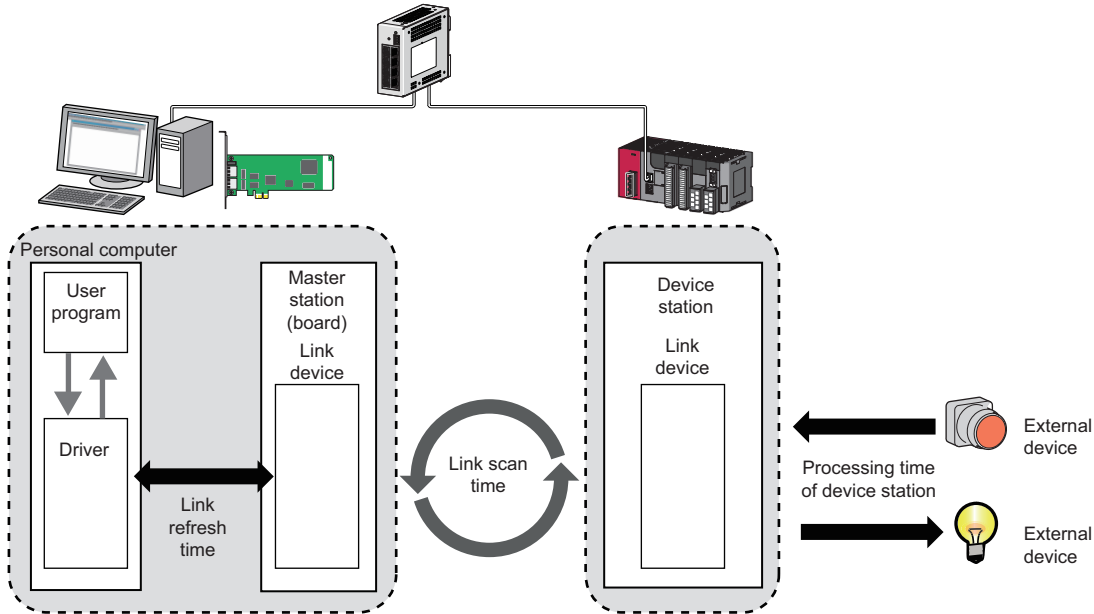

- Link refresh time: [Page 226 Link refresh time](#)
- Link scan time: [Page 227 Link scan time](#)
- Device station processing time: Manual for the device station used
- Transmission delay time: [Page 227 Transmission delay time](#)

## Link refresh time

The following is a calculation formula for the link refresh time.

Number of boards that can be installed × 1 [ms]

<For Intel® Core™ 2 Duo processor 1.8 GHz>

With a single board installed, the link refresh time of maximum link device points (36k bytes) is less than 1ms.

### Point

- Influence by other driver processing and Windows kernel processing  
The execution of the link refresh processing may be delayed by the interruption of other driver processing or Windows kernel processing.

## Link scan time

The following is a calculation formula for the link refresh time. (when the link scan mode is asynchronous)

$$LS = \left[ \left( \frac{RX \text{ points} + RY \text{ points}}{8} + (RW_r \text{ points} + RW_w \text{ points}) \times 2 \right) \times 0.08 \right. \\ \left. + (\text{Number of connected device stations} \times Ka) + Kb + Kc + Kd \right] \div 1000 \\ + (\text{Number of event conditions in Event Setting}) \times 0.02 \text{ [ms]}$$

Item	Cyclic transmission mode	
	Normal mode	High speed mode
Ka	25.8	<ul style="list-style-type: none"> <li>When "Turn OFF or 0 Clear Input Data (RX/Ry)" is set in the network operation setting: 18.5</li> <li>When "Hold Input Data (RX/Ry)" is set in the network operation setting: 9.75</li> </ul>
Kb	655	168
Kc (Maximum transient processing time)	160 + 60 × Total number of linked stations set in the parameters	80
Kd (Maximum data link processing time when disconnecting from network or reconnecting to network)	<ul style="list-style-type: none"> <li>When the serial number (first five digits) of the master station is '17022' or higher: Number of disconnected stations × 3500</li> <li>When the serial number (first five digits) of the master station is '17021' or lower: 9000 + Total number of ports used in the switching hub × 3000 (9000 when the switching hub is not used)</li> </ul>	

## Transmission delay time

The following are the calculation formulas for the transmission delay time.

### Master station (RX) ← Device station (input)

The following table shows the time after a signal is input to the device station until the board device of the master station turns ON or OFF.

Calculation value	Calculation formula
Normal value	SM × 0.5 + LS × 1 + device station response time [ms]
Maximum value	SM × 1 + LS × 2 + device station response time [ms]

SM: Master station link refresh time

LS : Link scan time

### Master station (RY) → Device station (output)

The following table shows the time after the board device is turned ON or OFF until the output of the device station is turned ON or OFF.

Calculation value	Calculation formula
Normal value	SM + LS × 1 + device station response time [ms]
Maximum value	SM + LS × 2 + device station response time [ms]

SM: Master station link refresh time

LS : Link scan time

A

# Appendix 6 Differences in Cyclic Transmission Modes

This section explains the differences between "Online (Normal Mode)" and "Online (High Speed Mode)" for the CC-Link IE Field Network board. Refer to the information in this section to select "Online (Normal Mode)" and "Online (High Speed Mode)".

## Differences in performance specifications

The following items can be selected.

Item	Online (Normal mode)	Online (High speed mode)
Maximum number of R/W send points per local station	1024 points, 2048 bytes	256 points, 512 bytes
Maximum number of transients per link scan	4 + device stations × 1.5	4

## Differences in link scan time

The link scan times in normal mode and high speed mode are shown below when assigning 128 points to RX/RV per station, 64 points to R/W/RVr per station, and the number of connected stations is increased.

Total number of stations	Link scan time (ms)			Total number of points for link devices (bytes)
	Online (Normal mode)	Online (High speed mode)		
		Network Operation Setting: "Turn OFF or 0 Clear Input Data (RX/RV)"	Network Operation Setting: "Hold Input Data (RX/RV)"	
2	0.75	0.24	0.23	576
4	0.85	0.33	0.29	1152
8	1.05	0.49	0.42	2304
16	1.44	0.82	0.68	4608
32	2.22	1.49	1.21	9216
64	3.78	2.82	2.26	17280
120	6.52	5.14	4.09	34560

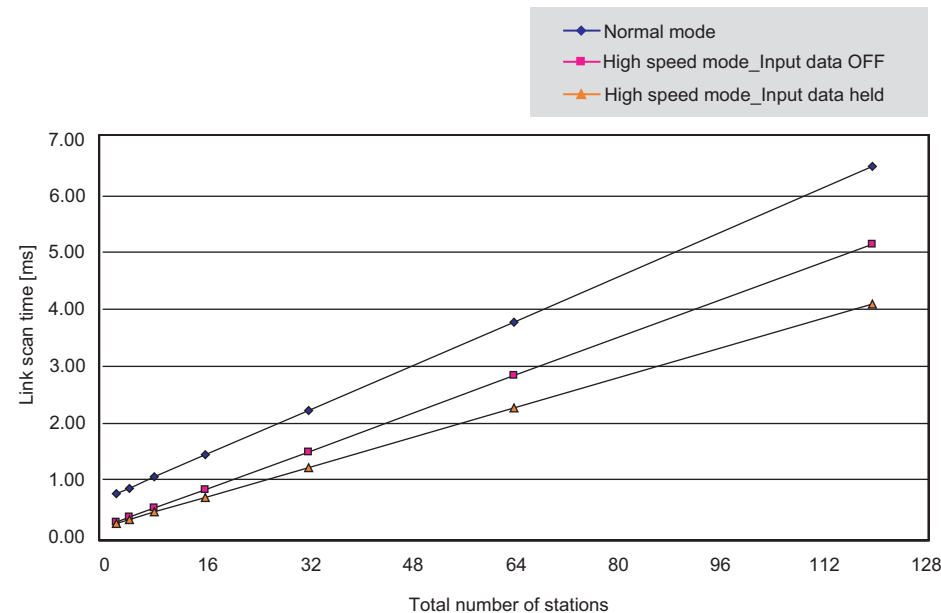

# Appendix 7 Comparison of CC-Link and CC-Link IE Field Network

This section explains the differences in the specifications between CC-Link Ver.2 board and CC-Link IE Field Network board.

## Performance specifications comparison

### ■Transmission and interface specifications

Item		Specifications	
		CC-Link Ver.2 board	CC-Link IE Field Network board
Maximum link points per network	RWw	2048 points* <sup>1</sup>	8192 points
	RWr	2048 points* <sup>1</sup>	8192 points
	RX	8192 points* <sup>1</sup>	16384 points
	RY	8192 points* <sup>1</sup>	16384 points
Maximum number of send points per station	Master station	RWw	2048 points* <sup>1</sup>
		RY	8192 points* <sup>1</sup>
	Local station	RWw	128 points* <sup>1</sup>
		RY	896 points* <sup>1</sup>
Transmission specifications	Communication speed	Selectable from 156 kbps/625 kbps/2.5 Mbps/5 Mbps/10 Mbps	1 Gbps
	Connection cable	CC-Link dedicated cable CC-Link dedicated high-performance cable Ver.1.10- compatible CC-Link dedicated cable	An Ethernet cable that meets the 1000BASE-T standard: Category 5e or higher (double shielded, STP), straight cable (☞ Page 29 Cables)
	Maximum station-to-station distance	30 cm to 1200 m (varies depending on connected stations and transmission speed)	100 m (compliant with ANSI/TIA/EIA-568-B (Category 5e)) (☞ Page 50 Ethernet cable connection)
	Overall cable distance	1200 m (at transmission speed of 156 kbps)	Line topology: 12000 m (when connected to 1 master station and 120 device stations) Star topology: Depends on the system configuration Ring topology: 12100 m (when connected to 1 master station and 120 device stations)
	Network topology	Bus topology	Line topology, star topology (coexistence of line topology and star topology is possible.), ring topology
Number of connected stations in one network	Master station	1 station (up to 64 remote stations can be connected to master station)	1 station (up to 120 device stations can be connected to master station)
	Local station	26 stations	120 stations
Station type	Master station, local station		
Communication method	Broadcast polling		Token passing method
Number of occupied I/O points	32 points (I/O assignment: Intelligent 32 points)		

\*<sup>1</sup> These are values in remote net ver.2 mode or remote net additional mode.

### ■Hardware specifications

Item	Specifications			
	CC-Link Ver.2 board		CC-Link IE Field Network board	
	Q80BD-J61BT11N	Q81BD-J61BT11	Q80BD-J71GF11-T2	Q81BD-J71GF11-T2
Internal current consumption	0.56 A (5 VDC)	1.06 A (3.3 VDC)	1.10 A (5 VDC)	1.68 A (3.3 VDC)
Installation slot	PCI slot	PCI Express slot	PCI bus slot, PCI-X slot	PCI Express slot
				Standard
External dimensions	121(H)×19(W)×153(D) [mm]		121(H)×18.5(W)×181(D) [mm]	121(H)×18.5(W)×181(D) [mm]
Weight	0.11 kg		0.11 kg	0.08 kg
			0.07 kg	

A

## Functional comparison

### ■ Added functions

The following are the functions added in the CC-Link IE Field Network.

Function		Description	Reference
Cyclic transmission	Mode selection for cyclic transmission	This mode can be selected for optimizing the performance of cyclic transmission based on the frequencies of cyclic transmission and transient transmission. The mode can be selected from "Online (Normal mode)" and "Online (High-speed mode)".	Page 99 Network type and mode Page 228 Differences in Cyclic Transmission Modes
Transient transmission	Seamless transmission with different networks	Setting the routing parameters beforehand also enables transient transmission to stations in different networks. Communication is also possible with the CC-Link IE Controller Network, and MELSECNET/H.	Page 67 Communication with different networks
CC-Link IE Field Network diagnostics	Network configuration display	The network configuration can be checked by CC-Link IE Field Network diagnostics of CC IE Field Utility.	Page 127 Diagnosing CC-Link IE Field Network
	Loop test	Check the network circuit status and parameter setting status of each station.	Page 52 Loop test
	Cable test	Check the connection status of the Ethernet cable.	Page 53 Cable test
	Communication test	Check whether the communication path for transient transmission from the own station to the target station is correct.	Page 54 Communication test
	Network event history	The history of events that occurred in the own station and on the network is displayed. For the master station, the event history of the entire network can be displayed, and so it can be used for troubleshooting at network start-up.	Page 141 Network event history
Other	Reserved station temporary disablement	Reserved stations can be temporarily disabled without changing parameters.	Page 73 Reserved Station Specification and Reserved Station Function Disable Function Page 143 Reserved station function enable

### ■ Modified functions

The following are the functions modified in the CC-Link IE Field Network board.

Function	Notes during replacement
Device station cut-off function	When the CC-Link IE Field Network is connected in a line topology, stations after the disconnected station become data link faulty stations. To prevent disconnection of normal stations, connect the CC-Link IE Field Network in a star topology. (☞ Page 20 Network configuration)
Standby master function	No standby master function is available in the CC-Link IE Field Network board.
Data link status setting for error occurrence of CC-Link module master station CPU	The setting is fixed to "Continue" for CC-Link IE Field Network.

# Appendix 8 Combinations with Existing Software

---

There is no restriction when using CC-Link IE Field Network board with other MELSEC interface boards or MELSOFT products on the same personal computer.

For the restrictions of the applicable operating environment or applicable access target, refer to the manual of each product.

# Appendix 9 Checking Serial Number and Function Version

Explains a method for checking a serial number and a function version of CC-Link IE Field Network board.

## Checking on the rating plate

The serial number and function version of CC-Link IE Field Network board can be checked in the SERIAL column of rating plate.

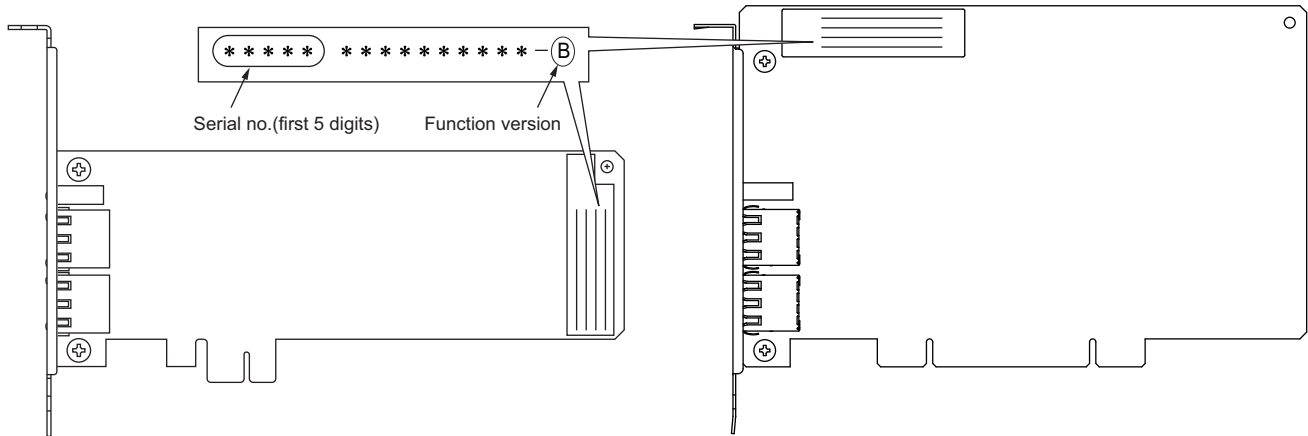

## Checking on the CC IE Field utility

The serial number and function version are displayed in the "Board Diagnostics" screen in the CC IE Field Utility.

### Window

[Diagnostics] ⇄ [Board Diagnostics]

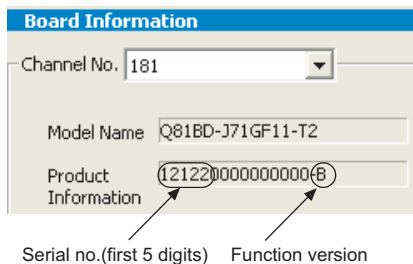

### Point

The serial number displayed in the SERIAL column of the "Board Diagnostics" screen in the CC IE Field Utility may differ from that on the rating plate of the CC-Link IE Field Network board.

- The serial number in the SERIAL column of the rating plate of the CC-Link IE Field Network board indicates the management information of the product.
- The serial number displayed in the "Board Diagnostics" screen in the CC IE Field Utility indicates the functional information of the product. The functional information of the product is updated when a new function is added.

# Appendix 10 Added and Changed Functions

## Change of hardware function

The following table shows the new or improved function for CC-Link IE Field Network board.

Added/changed contents	First five digits of the serial number	Version of SW1DNC-CCIEF-B
Parameter setting function for CC-Link IE Field Network remote device station (mdRemBufWriteEx function, mdRemBufReadEx function)	15102 or higher	1.06G or later (A 64-bit version user application is supported by SW1DNC-CCIEF-B version 1.12N or later.)
Change of the calculation method for maximum data link processing time when the station is disconnected from or returned to the network, which is used for the link scan time formula	17022 or higher	—
Network map update in the CC-Link IE Field Network diagnostics		
Connection to a MELSEC iQ-R series redundant system including CC-Link IE Field Network	18042 or higher	—

## Update of software package

For details on the updated version of software and the functions which are added or changed, please contact your local Mitsubishi Electric sales office or representative.

# Appendix 11 Windows User Account Control

The user account control (UAC) is provided to protect the system from being destroyed (e.g. prevention of start-up of a program which will execute an unintended operation).

## Confirmation message

When the user account control function is enabled, a message for the user account control appears at the following timings:

- Installing/uninstalling a software package
- Starting CC IE Field Utility

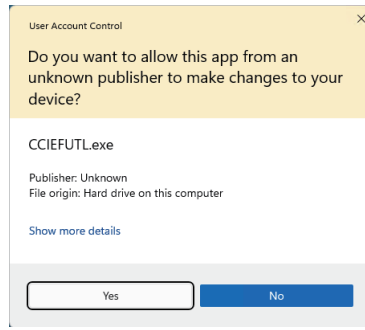
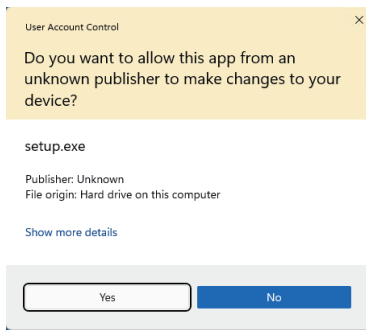

When a message appears, click the [Yes] button.

## Methods for displaying a message

If a software package cannot be installed or if a message for the user account control does not appear when starting CC IE Field Utility, enable the user account control setting by the following procedures.

### Method for enabling the user account control function

1. Select [System and Security] ⇒ [Change User Account Control settings] in the control panel of Windows.
2. Set the slide bar to an item other than "Never notify" and click the [OK] button.

### Method for setting the local security policy

1. Open the "Local Security Policy" screen on Windows.  
It appears by entering 'secpol.msc' in the "Run" screen that appears by pressing the Windows key + [R].
2. Select [Local Policies] ⇒ [Security Options] in the "Local Security Policy" screen.
3. Set the following policies:

Policy	Security setting
User Account Control: Detect application installations and prompt for elevation	Enable
User Account Control: Run all administrators in Admin Approval Mode	Enable
User Account Control: Behavior of the elevation prompt for administrators in Admin Approval Mode	Prompt for consent for non-Windows binaries

# Appendix 12 Behavior When Personal Computer Enters Power Save Mode or Fast Startup

CC-Link IE Field Network board does not support the power save mode (hibernate, sleep) and fast startup. The following explains the behavior of the personal computer when the personal computer enters each mode.

## Behavior when the personal computer enters the power save mode (hibernate, sleep)

### Behavior when entering the hibernation mode/sleep mode

The following explains the behavior of the board when the power save mode (hibernate, sleep) is entered on the personal computer.

- The CC-Link IE Field Network board stops its operation and is disconnected from the network.
- The board is not reconnected even after the personal computer returns from the power save mode (hibernate, sleep).
- After the personal computer returns from the power save mode (hibernate, sleep), "-28141(9213H) : System sleep error" occurs when accessing CC-Link IE Field Network board from the CC IE Field utility or an application program, which includes MELSEC data link library function.

### Corrective action

When the personal computer is set to enter the power save mode (hibernate, sleep), the setting is changed by MELSECPowerManager.

For details on MELSECPowerManager, refer to the following:

 Page 236 MELSECPowerManager

## Behavior when fast startup function is enabled

### Behavior when the fast startup function is enabled

The following explains the behavior of the board when the fast startup function is enabled.

- The board is not reconnected even after the fast startup.
- After the fast startup, "-28141(9213H) : System sleep error" occurs when accessing CC-Link IE Field Network board from the CC IE Field utility or an application program, which includes MELSEC data link library function.

### Corrective action

When the fast startup function is enabled on the personal computer, the setting is changed by MELSECPowerManager.

For details on MELSECPowerManager, refer to the following:

 Page 236 MELSECPowerManager

# Appendix 13 MELSECPowerManager

MELSECPowerManager is a service application which monitors the Windows Power Options settings every 30 seconds to prevent the personal computer from entering the power save mode (hibernate, sleep) or the fast startup function. When a personal computer is set to enter the power save mode (hibernate, sleep) or the fast startup function is enabled, the following message is displayed and the setting is changed by MELSECPowerManager.

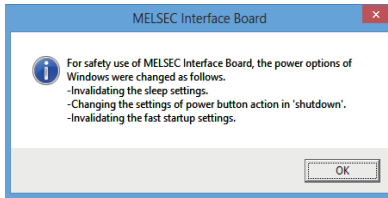

## Installing MELSECPowerManager

MELSECPowerManager is installed automatically when the software package is installed to a personal computer. The operation starts after the OS is restarted.

## Uninstalling MELSECPowerManager

MELSECPowerManager is uninstalled automatically when the software package is uninstalled. However, it is not uninstalled when another software package of MELSEC network interface board is installed to the personal computer. Uninstall all software packages for MELSEC network interface board installed on the personal computer to uninstall MELSECPowerManager.

## Checking MELSECPowerManager

MELSECPowerManager can be checked by selecting [Windows Tools] ⇒ [Services] in Windows. Check that "MELSECPowerManager" is displayed and "Running" is displayed under "Status."

### Point

- When MELSECPowerManager is disabled, the personal computer may enter the power save mode (hibernate, sleep) automatically depending on the settings on the personal computer. Do not disable MELSECPowerManager because the CC-Link IE Field Network board does not function normally if the personal computer enters the power save mode (hibernate, sleep). For the behavior of the board when the personal computer enters the power save mode (hibernate, sleep), or the fast startup function is enabled, refer to the following:  
(☞ Page 235 Behavior When Personal Computer Enters Power Save Mode or Fast Startup)
- If MELSECPowerManager is disabled accidentally, right-click "MELSECPowerManager" in the "Services (Local)" screen and select [Start] from the menu.

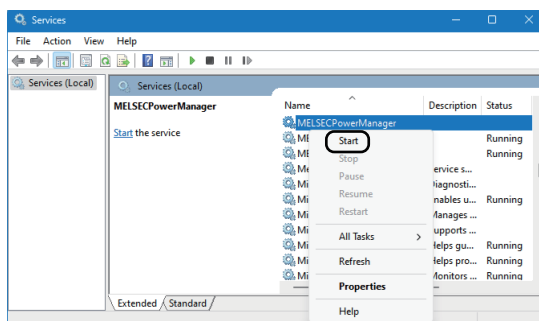

# Appendix 14 EMC and Low Voltage Directives

In each country, laws and regulations concerning electromagnetic compatibility (EMC) and electrical safety are enacted. For the products sold in the European countries, compliance with the EU's EMC Directive has been a legal obligation as EMC regulation since 1996, as well as the EU's Low Voltage Directive as electrical safety regulation since 1997.

Manufacturers who recognize their products are compliant with the EMC and Low Voltage Directives are required to attach a "CE marking" on their products in European countries.

In some other countries and regions, manufacturers are required to make their products compliant with applicable laws or regulations and attach a certification mark on the products as well (such as UK Conformity Assessed (UKCA) marking in the UK, and Korea Certification (KC) marking in South Korea).

Each country works to make their regulatory requirements consistent across countries based on international standards. When the requirements are consistent, measures to comply with the EMC and electrical safety regulations become common across countries.

The UK and South Korea have enacted EMC regulations whose requirements are consistent with those of the EMC Directive. The UK has also enacted electrical safety regulations whose requirements are consistent with those of the Low Voltage Directive. In this section, the requirements of the EMC and Low Voltage Directives are described as examples of those of the EMC and electrical safety regulations.

## Measures to comply with the EMC Directive

The EMC Directive sets requirements for emission (conducted and radiated electromagnetic interference emitted by a product) and immunity (the ability of a product not to be influenced by externally generated electromagnetic interference).

This section describes the precautions for machinery constructed with this product to comply with the EMC Directive.

These precautions are based on the requirements of the EMC Directive and the harmonized standards. However, they do not guarantee that the entire machinery constructed according to the descriptions complies with the EMC Directive.

The manufacturer of the machinery must determine the testing method for compliance and declare conformity to the EMC Directive.

### EMC Directive related standards

#### ■ Emission requirements

Standard	Test item	Test description	Value specified in standard
EN61131-2: 2007	CISPR16-2-3 Radiated emission* <sup>1</sup>	The electromagnetic wave which the product emits to the external space is measured.	<ul style="list-style-type: none"> <li>• 30 to 230 MHz, QP: 40 dB<math>\mu</math>V/m (measured at 10 m distance)<sup>2</sup></li> <li>• 230 to 1000 MHz, QP: 47 dB<math>\mu</math>V/m (measured at 10 m distance)</li> </ul>
	CISPR16-2-1, CISPR16-1-2 Conducted emission* <sup>1</sup>	The noise level which the product emits to the power line is measured.	<ul style="list-style-type: none"> <li>• 0.15 to 0.5 MHz, QP: 79 dB, Mean: 66 dB<sup>2</sup></li> <li>• 0.5 to 30 MHz, QP: 73 dB, Mean: 60 dB</li> </ul>

\*1 The tests were conducted with the product installed in a control panel.

\*2 QP: Quasi-Peak value, Mean: Average value

## ■ Immunity requirements

Standard	Test item	Test description	Value specified in standard
EN61131-2: 2007	EN61000-4-2 Electrostatic discharge immunity <sup>*1</sup>	An electrostatic discharge is applied to the enclosure of the equipment.	<ul style="list-style-type: none"> <li>• 8kV Air discharge</li> <li>• 4kV Contact discharge</li> </ul>
	EN61000-4-3 Radiated, radio-frequency, electromagnetic field immunity <sup>*1</sup>	An electric field is radiated to the product.	80% AM modulation @1kHz <ul style="list-style-type: none"> <li>• 80 to 1000 MHz: 10 V/m</li> <li>• 1.4 to 2.0 GHz: 3 V/m</li> <li>• 2.0 to 2.7 GHz: 1 V/m</li> </ul>
	EN61000-4-4 Fast transient/burst immunity <sup>*1</sup>	Burst noise is applied to power lines and signal lines.	<ul style="list-style-type: none"> <li>• AC/DC power, I/O power, and AC I/O (unshielded) lines: 2kV</li> <li>• DC I/O, analog, and communication lines: 1kV</li> </ul>
	EN61000-4-5 Surge immunity <sup>*1</sup>	Lightning surge is applied to power lines and signal lines.	<ul style="list-style-type: none"> <li>• AC power, AC I/O power, and AC I/O (unshielded) lines: 2kV CM, 1kV DM</li> <li>• DC power and DC I/O power lines: 0.5kV CM, 0.5kV DM</li> <li>• DC I/O, AC I/O (shielded), analog, and communication lines: 1kV CM</li> </ul>
	EN61000-4-6 Conducted RF immunity <sup>*1</sup>	High-frequency noise is applied to power lines and signal lines.	0.15 to 80 MHz 80% AM modulation @1kHz, 10Vrms
	EN61000-4-8 Power-frequency magnetic field immunity <sup>*1</sup>	The product is immersed in the magnetic field of an induction coil.	50/60 Hz, 30 A/m
	EN61000-4-11 Voltage dips and interruption immunity <sup>*1</sup>	Power voltage is momentarily interrupted.	<ul style="list-style-type: none"> <li>• 0%, 0.5 period, starting at zero crossing</li> <li>• 0%, 250/300 period (50/60 Hz)</li> <li>• 40%, 10/12 period (50/60 Hz)</li> <li>• 70%, 25/30 period (50/60 Hz)</li> </ul>

\*1 The tests were conducted installed in a control panel.

## Installation in a control panel

This ensures safety as well as effective shielding of electromagnetic noise emitted from a personal computer.

### ■ Control panel

- Use a conductive control panel.
- Mask off an area used for grounding when securing the top or bottom plate to the control panel using bolts.
- To ensure electrical contact between inner plates and the control panel, mask off the bolt installation areas of each inner plate so that conductivity can be ensured in the largest area.
- Ground the control panel with a thick ground cable so that low impedance can be ensured even at high frequencies.
- Keep the diameter of the holes on the control panel to 10 cm or less. If the diameter is larger than 10 cm, electromagnetic wave may leak. In addition, because electromagnetic wave leaks through a clearance between the control panel and its door, reduce the clearance as much as possible. Use of EMI gaskets (sealing the clearance) can suppress undesired radiated emissions.

The tests were conducted by Mitsubishi Electric Corporation using a control panel having damping characteristics of 37 dB (maximum) and 30 dB (average) (measured at 3 m distance, 30 to 300 MHz).

### ■ Power cable and ground cable

- Provide a ground point to the control panel near the power of a personal computer. Ground the FG terminal of the personal computer to the ground point with the thickest and shortest ground cable possible (a thickness at least 2 mm<sup>2</sup>, a length of 30 cm or shorter).
- Twist the ground cable extended from the ground point with the power cable so that larger amount of noise generated from the power cable is absorbed to the ground. Note that if a noise filter is attached to the power cable, twisting may not be required.

## Cables

Use a shielded cable for a cable extended out of the control panel.

If a shielded cable is not used or not grounded correctly, the noise immunity will not meet the required value.

### ■CC-Link IE Field Network cables

The precautions for using CC-Link IE Field Network cables are described below.

- Use a cable recommended by CC-Link Partner Association.
- The cable is shielded. Strip a part of the jacket as shown below and ground the exposed shield to the largest area.

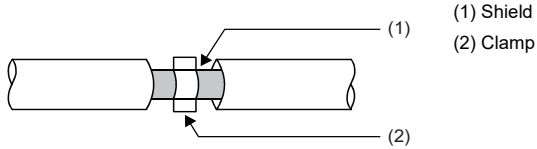

### ■Grounding a shielded cable

Ground the shield of a shielded cable as close to the exit from the control panel as possible.

Otherwise, the cable after the ground point will cause electromagnetic induction, and will generate a higher harmonic noise.

Ground the exposed shield to a large area on the control panel.

A clamp can be used as shown below. In this case, mask off the inner wall surface of the control panel, which comes in contact with the clamp.

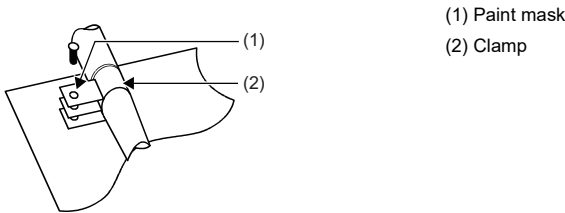

### Point

Do not use the tip of a PVC wire soldered onto a shield of the shielded cable for grounding. Doing so will raise the high-frequency impedance, resulting in loss of the shielding effect.

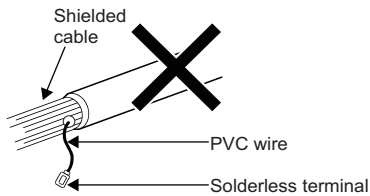

### ■Grounding cables with a cable clamp

Use shielded cables for external wiring and ground the shields of the shielded cables to the control panel with an AD75CK cable clamp (manufactured by Mitsubishi Electric). Ground the shields within 20 to 30 cm from the module.

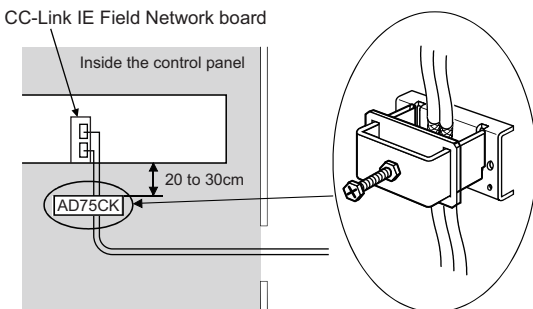

For details on the AD75CK, refer to the following:

📖 AD75CK-type Cable Clamping Instruction Manual

## Noise filter (power supply line filter)

A noise filter is effective for reducing conducted noise in the 10 MHz or less frequency band. (Use of a noise filter can suppress noise.)

The following are the installation precautions.

- Do not bundle the cables on the input side and output side of the noise filter. If bundled, the noise on the output side is induced into the filtered cable on the input side.

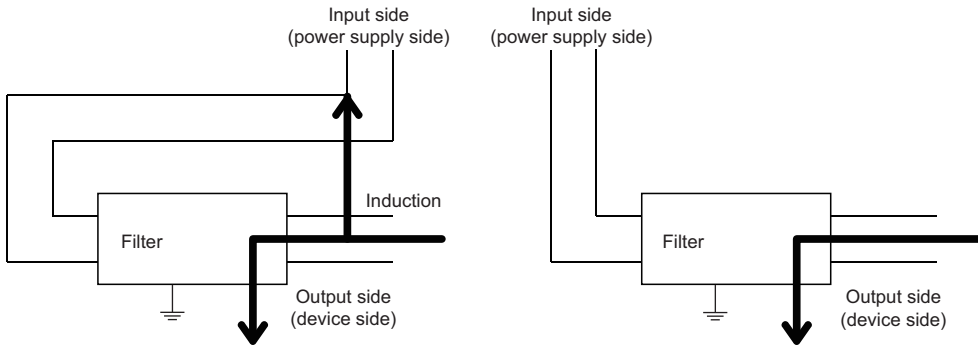

Noise will be induced when the input and output cables are bundled.

Separately install the input and output cables.

- Ground the ground terminal of the noise filter to the ground point of the control panel with the shortest cable possible (approximately 10 cm).

## Measures to comply with the Low Voltage Directive

This board is out of the requirement for conformance to the Low Voltage Directive, since it does not use the power supply in the range of 50 to 1000 VAC and 75 to 1500 VDC.

# Appendix 15 External Dimensions

The following figures show the external dimensions of each board.

## Q80BD-J71GF11-T2

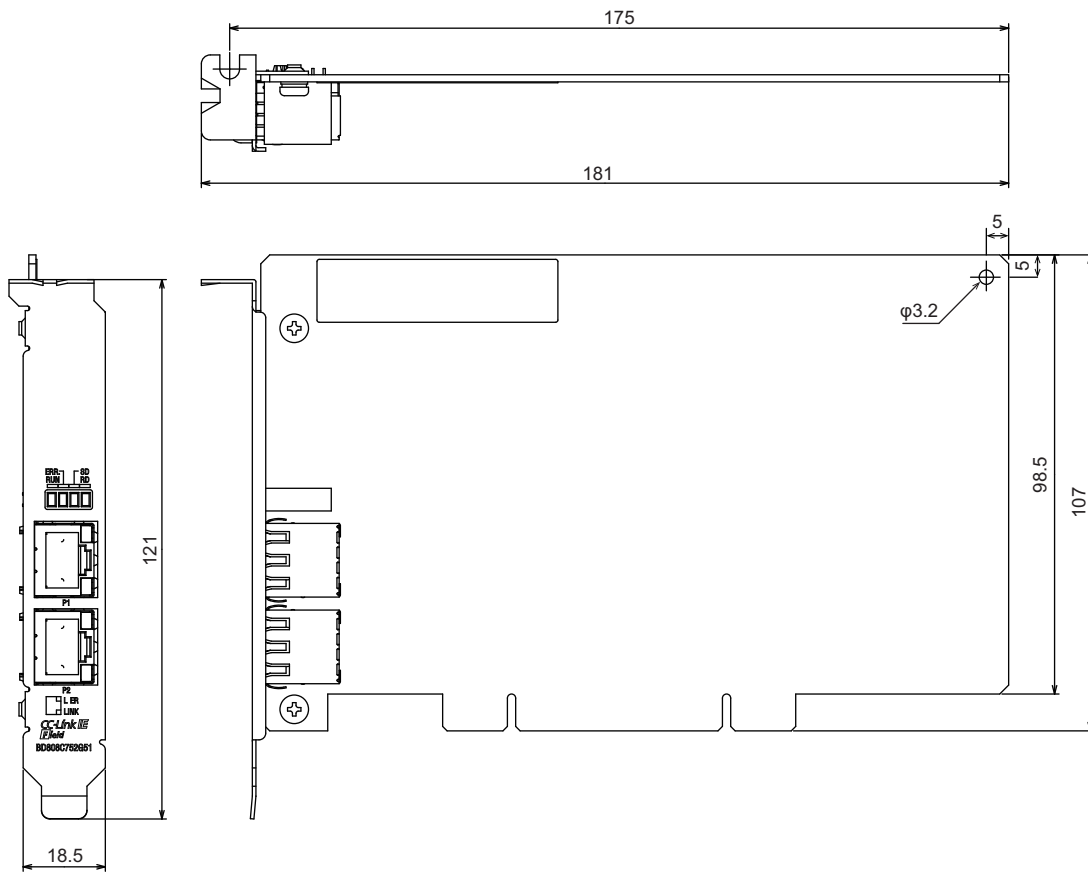

(Unit: mm)

A

# Q81BD-J71GF11-T2

## Q81BD-J71GF11-T2 (standard size)

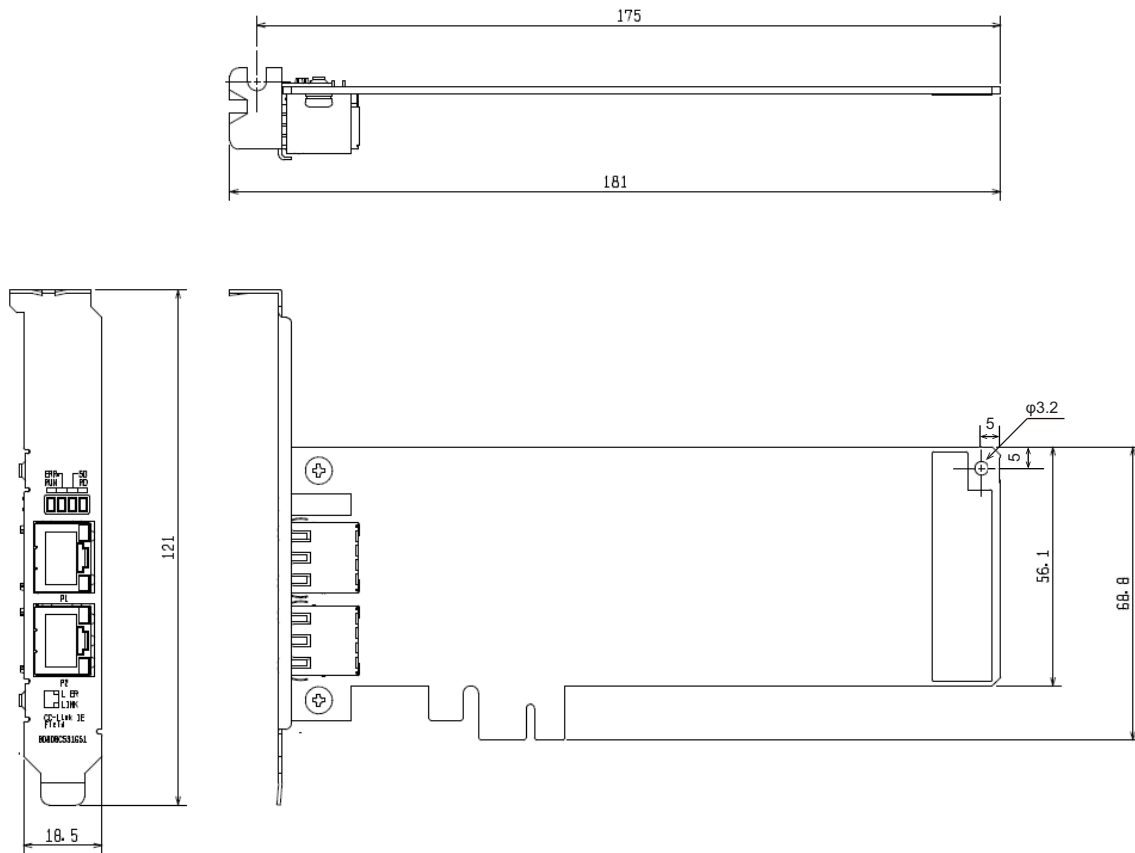

(Unit: mm)

## Q81BD-J71GF11-T2 (low profile size)

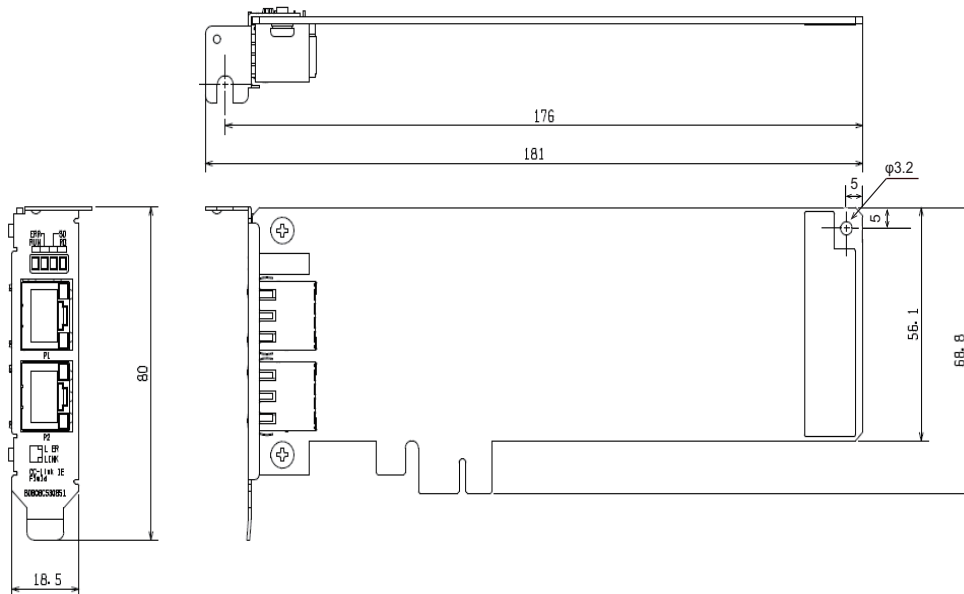

(Unit: mm)

# MEMO

---

A

# INDEX

---

## 0 to 9

---

32-bit data assurance . . . . . 62

## A

---

About . . . . . 89  
Automatic return . . . . . 57

## B

---

Block data assurance per station . . . . . 63  
Board Diagnostics . . . . . 125  
Buffer memory . . . . . 35,192

## C

---

Cable clamp . . . . . 239  
CC IE Field Diagnostics . . . . . 128  
CC IE Field Utility . . . . . 79,82  
CC-Link IE Field Network diagnostics . . . . . 127  
Channel number . . . . . 44,120  
Cyclic transmission . . . . . 56

## D

---

D LINK LED . . . . . 172  
Data link faulty station . . . . . 64  
Device Monitor Utility . . . . . 79,123  
Device station . . . . . 13,56  
Driver WDT function . . . . . 77  
Driver WDT monitoring time . . . . . 114

## E

---

EMC Directive . . . . . 237  
Emission . . . . . 237  
Error code . . . . . 177  
Error invalid station . . . . . 74  
Event . . . . . 75  
External dimension . . . . . 241

## F

---

Function version . . . . . 232

## H

---

Help . . . . . 89

## I

---

Immunity . . . . . 238

## L

---

L ERR. LED . . . . . 173  
LED . . . . . 171  
Line topology . . . . . 20  
Link device . . . . . 35  
Link points . . . . . 34  
Link refresh . . . . . 58,226

Link scan . . . . . 58,227  
Link special register (SW) . . . . . 193  
Link special relay (SB) . . . . . 193  
Local station . . . . . 99  
Loopback function . . . . . 57,101  
Low profile size . . . . . 40

## M

---

Master station . . . . . 99  
MD functions . . . . . 146  
Mode . . . . . 99,228  
MODE LED . . . . . 172

## N

---

Network configuration . . . . . 129  
Network type . . . . . 99  
Noise filter . . . . . 240  
Number of connectable stations . . . . . 34

## P

---

P1 . . . . . 40  
P2 . . . . . 40  
Patch cord removal tool . . . . . 49  
PCI bus . . . . . 30  
PCI Express bus . . . . . 30  
PORT1 connector . . . . . 40  
PORT2 connector . . . . . 40  
Product information . . . . . 125

## R

---

RAS . . . . . 57  
Rating plate . . . . . 232  
Remote input (RX) . . . . . 192  
Remote output (RY) . . . . . 192  
Remote register (RWr) . . . . . 193  
Remote register (RWw) . . . . . 193  
Reserved station . . . . . 73  
Ring topology . . . . . 20  
Routing parameters . . . . . 67,116  
RWr . . . . . 100,193  
RWw . . . . . 100,193  
RX . . . . . 100,192  
RY . . . . . 100,192

## S

---

Screw tightening torque . . . . . 43  
Serial number . . . . . 232  
Standard size . . . . . 39  
Star topology . . . . . 20

## T

---

Temporary error invalid station . . . . . 74  
Transient transmission . . . . . 56

## U

---

Utility .....	82
---------------	----



# REVISIONS

\*The manual number is given on the bottom left of the back cover.

Revision date	*Manual number	Description
May 2011 to June 2015	SH(NA)-080980ENG-A to SH(NA)-080980ENG-I	Due to the transition to the e-Manual, the details of revision have been deleted.
May 2016	SH(NA)-080980ENG-J	Complete revision (layout change)
September 2016	SH(NA)-080980ENG-K	■Added or modified parts Section 2.4, Section 6.2, Section 8.1, Chapter 12, Section 13.2, Section 16.2, Appendix 3, Appendix 4, Appendix 11, Appendix 12, Appendix 13, Appendix 14
January 2017	SH(NA)-080980ENG-L	■Added or modified parts Chapter 14, Appendix 10
March 2017	SH(NA)-080980ENG-M	■Added or modified part Section 2.4
September 2017	SH(NA)-080980ENG-N	■Added or modified parts Section 2.4, Section 6.1, Section 16.2
July 2019	SH(NA)-080980ENG-O	■Added or modified parts RELEVANT MANUALS, Section 2.4, Section 6.1, Appendix 13, Appendix 14, Appendix 15, Appendix 16
February 2020	SH(NA)-080980ENG-P	■Added or modified part Section 2.4
September 2021	SH(NA)-080980ENG-Q	■Added or modified part Appendix 15
January 2022	SH(NA)-080980ENG-R	■Added or modified parts SAFETY PRECAUTIONS, CONDITIONS OF USE FOR THE PRODUCT, TERMS, GENERIC TERMS AND ABBREVIATIONS, Section 2.1, Section 2.4, Section 6.1, Section 6.2, Section 16.2, Appendix 10, Appendix 11, Appendix 15 ■Deleted part PACKING LIST
May 2022	SH(NA)-080980ENG-S	■Added or modified parts INTRODUCTION, Section 16.7, COPYRIGHT
April 2024	SH(NA)-080980ENG-T	■Added or modified parts Section 2.4, Section 6.1, Appendix 3, Appendix 4
September 2024	SH(NA)-080980ENG-U	■Added or modified parts Section 2.4, Section 6.1, Section 6.2, Section 8.1, Section 8.2, Section 8.3, Appendix 11, Appendix 12, Appendix 13, Appendix 14
November 2024	SH(NA)-080980ENG-V	■Added or modified parts Section 2.2, Section 16.1, Section 16.5
June 2025	SH(NA)-080980ENG-W	■Added or modified parts Section 2.4
March 2026	SH(NA)-080980ENG-X	■Added or modified parts Section 2.4, Section 6.2, Section 8.3, Section 10.2, Section 10.3, Section 13.2, Section 16.3, Section 16.7, Appendix 10 ■Deleted part Appendix 11

Japanese manual number: SH-080925-Y

This manual confers no industrial property rights or any rights of any other kind, nor does it confer any patent licenses. Mitsubishi Electric Corporation cannot be held responsible for any problems involving industrial property rights which may occur as a result of using the contents noted in this manual.

© 2011 MITSUBISHI ELECTRIC CORPORATION

# WARRANTY

---

Please confirm the following product warranty details before using this product.

## **1. Gratis Warranty Term and Gratis Warranty Range**

If any faults or defects (hereinafter "Failure") found to be the responsibility of Mitsubishi occurs during use of the product within the gratis warranty term, the product shall be repaired at no cost via the sales representative or Mitsubishi Service Company.

However, if repairs are required onsite at domestic or overseas location, expenses to send an engineer will be solely at the customer's discretion. Mitsubishi shall not be held responsible for any re-commissioning, maintenance, or testing on-site that involves replacement of the failed module.

[Gratis Warranty Term]

The gratis warranty term of the product shall be for one year after the date of purchase or delivery to a designated place. Note that after manufacture and shipment from Mitsubishi, the maximum distribution period shall be six (6) months, and the longest gratis warranty term after manufacturing shall be eighteen (18) months. The gratis warranty term of repair parts shall not exceed the gratis warranty term before repairs.

[Gratis Warranty Range]

- (1) The range shall be limited to normal use within the usage state, usage methods and usage environment, etc., which follow the conditions and precautions, etc., given in the instruction manual, user's manual and caution labels on the product.
- (2) Even within the gratis warranty term, repairs shall be charged for in the following cases.
  1. Failure occurring from inappropriate storage or handling, carelessness or negligence by the user. Failure caused by the user's hardware or software design.
  2. Failure caused by unapproved modifications, etc., to the product by the user.
  3. When the Mitsubishi product is assembled into a user's device, Failure that could have been avoided if functions or structures, judged as necessary in the legal safety measures the user's device is subject to or as necessary by industry standards, had been provided.
  4. Failure that could have been avoided if consumable parts (battery, backlight, fuse, etc.) designated in the instruction manual had been correctly serviced or replaced.
  5. Failure caused by external irresistible forces such as fires or abnormal voltages, and Failure caused by force majeure such as earthquakes, lightning, wind and water damage.
  6. Failure caused by reasons unpredictable by scientific technology standards at time of shipment from Mitsubishi.
  7. Any other failure found not to be the responsibility of Mitsubishi or that admitted not to be so by the user.

## **2. Onerous repair term after discontinuation of production**

- (1) Mitsubishi shall accept onerous product repairs for seven (7) years after production of the product is discontinued. Discontinuation of production shall be notified with Mitsubishi Technical Bulletins, etc.
- (2) Product supply (including repair parts) is not available after production is discontinued.

## **3. Overseas service**

Overseas, repairs shall be accepted by Mitsubishi's local overseas FA Center. Note that the repair conditions at each FA Center may differ.

## **4. Exclusion of loss in opportunity and secondary loss from warranty liability**

Regardless of the gratis warranty term, Mitsubishi shall not be liable for compensation to:

- (1) Damages caused by any cause found not to be the responsibility of Mitsubishi.
- (2) Loss in opportunity, lost profits incurred to the user by Failures of Mitsubishi products.
- (3) Special damages and secondary damages whether foreseeable or not, compensation for accidents, and compensation for damages to products other than Mitsubishi products.
- (4) Replacement by the user, maintenance of on-site equipment, start-up test run and other tasks.

## **5. Changes in product specifications**

The specifications given in the catalogs, manuals or technical documents are subject to change without prior notice.

# INFORMATION AND SERVICES

---

For further information and services, please contact your local Mitsubishi Electric sales office or representative.  
Visit our website to find our locations worldwide.

MITSUBISHI ELECTRIC Factory Automation Global Website  
Locations Worldwide  
[www.MitsubishiElectric.com/fa/about-us/overseas/](http://www.MitsubishiElectric.com/fa/about-us/overseas/)

## TRADEMARKS

---

Adobe and Acrobat Reader are either registered trademarks or trademarks of Adobe in the United States and/or other countries.

PCI Express is either a registered trademark or a trademark of PCI-SIG.

Microsoft, Visual Basic, Visual C++, Visual Studio, Windows, Windows Vista, and Windows XP are trademarks of the Microsoft group of companies.

The company names, system names and product names mentioned in this manual are either registered trademarks or trademarks of their respective companies.

In some cases, trademark symbols such as <sup>™</sup> or <sup>®</sup> are not specified in this manual.

## COPYRIGHTS

---

The screens (screenshots) are used in accordance with the Microsoft Corporation guideline.



TRANSLATION OF THE ORIGINAL INSTRUCTIONS

SH(NA)-080980ENG-X(2603)MEE

MODEL: SW1-CCIEF-B-U-E

## **MITSUBISHI ELECTRIC CORPORATION**

HEAD OFFICE: TOKYO BLDG., 2-7-3, MARUNOUCHI, CHIYODA-KU, TOKYO 100-8310, JAPAN  
NAGOYA WORKS: 1-14, YADA-MINAMI 5-CHOME, HIGASHI-KU, NAGOYA 461-8670, JAPAN

When exported from Japan, this manual does not require application to the  
Ministry of Economy, Trade and Industry for service transaction permission.

Specifications subject to change without notice.