

DC CURRENT OUTPUT MODULE
(4 points, isolated, tension clamp terminal block)MODEL **R3S-YS4****BEFORE USE**

Thank you for choosing M-System. Before use, please check contents of the package you received as outlined below.

If you have any problems or questions with the product, please contact M-System's Sales Office or representatives.

■ PACKAGE INCLUDES:

DC current output module.....(1)

■ MODEL NO.

Confirm Model No. marking on the product to be exactly what you ordered.

■ INSTRUCTION MANUAL

This manual describes necessary points of caution when you use this product, including installation, connection and basic maintenance procedures.

POINTS OF CAUTION**■ HOT SWAPPABLE MODULES**

- Replacing the module does not affect other modules on the same base. Thus, the module can be replaced while the power is ON. However, replacing multiple modules at once may greatly change live voltage levels. We highly recommend to replace them one by one.

■ GENERAL PRECAUTIONS

- DO NOT set the switches on the module while the power is supplied. The switches are used only for maintenance without the power.

■ ENVIRONMENT

- Indoor use.
- When heavy dust or metal particles are present in the air, install the unit inside proper housing with sufficient ventilation.
- Do not install the unit where it is subjected to continuous vibration. Do not subject the unit to physical impact.
- Environmental temperature must be within -10 to +55°C (14 to 131°F) with relative humidity within 30 to 90% RH in order to ensure adequate life span and operation.

■ WIRING

- Do not install cables close to noise sources (relay drive cable, high frequency line, etc.).
- Do not bind these cables together with those in which noises are present. Do not install them in the same duct.

■ UNUSED OUTPUT CHANNEL

- Close across the unused output terminals or set unused channels to "unused" with PC Configurator software (model: R3CON).

■ AND

- The unit is designed to function as soon as power is supplied, however, a warm up for 10 minutes is required for satisfying complete performance described in the data sheet.

INSTALLATION

Use the Installation Base (model: R3-BSx).

COMPONENT IDENTIFICATION

■ FRONT VIEW

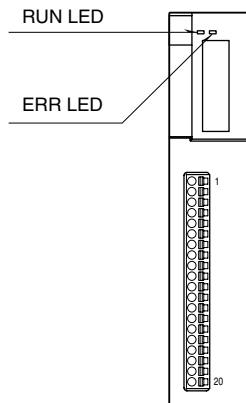

■ SIDE VIEW

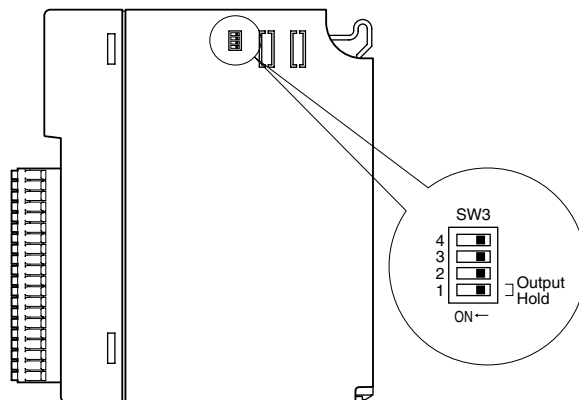

■ STATUS INDICATOR LED

RUN indicator: Bi-color (red/green) LED;

Red when the bus A operates normally;
Green when the bus B operates normally;
Amber when both buses operate normally.

ERR indicator: Bi-color (red/green) LED;

Red with output abnormality;
Green in normal operating conditions.

■ SIDE DIP SW

• Output Hold: SW31

SW	OUTPUT HOLD	
	HOLD (*)	OFF
SW3-1	OFF	ON

(*) Factory setting

Note: Be sure to set unused SW3-2 through 3-4 to OFF.

PC CONFIGURATOR

With configurator software, settings shown below are available.
Refer to the software manual of R3CON for detailed operation.

■ CHANNEL INDIVIDUAL SETTING

PARAMETER	AVAILABLE RANGE	DEFAULT SETTING
Zero Scale	-32000 to +32000	0
Full Scale	-32000 to +32000	10000
Zero Adjust	-320.00 to +320.00	0.00
Full Adjust	-32000 to +32000	1.0000
Unused	0: Enable 1: Disable	0: Enable

TERMINAL CONNECTIONS

Connect the unit as in the diagram below.

EXTERNAL DIMENSIONS unit: mm (inch)

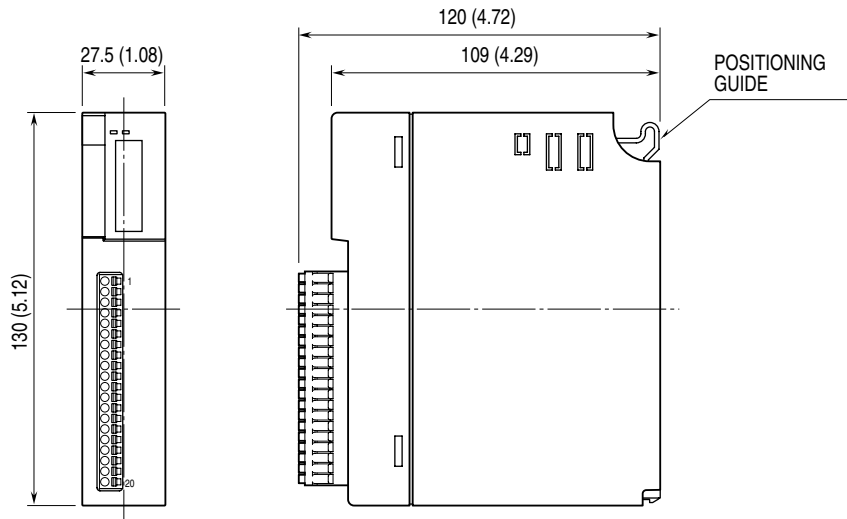

CONNECTION DIAGRAM

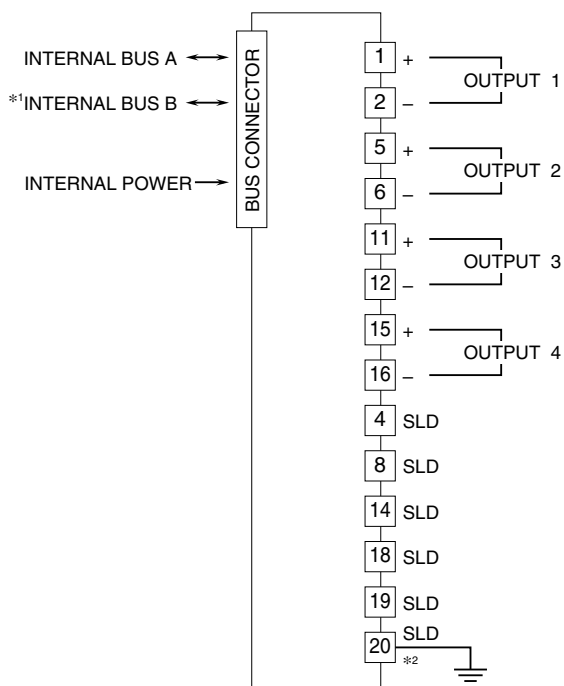

- *1. For dual redundant communication.
 - *2. To use shield line, connect it to SLD terminal and ground the terminal 20.
- Note: Do not use void terminals.

Unused Output Channels

Close across the unused output terminals as shown below.

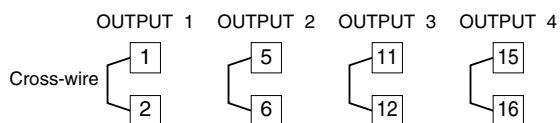

Unused channels left open are equal to the wire breakdown, which turns the red ERR LED on and sets a burnout flag at the PLC or the host device.

Unused channels can be specified and set so on the PC Configurator Software (model: R3CON) without needing to short at the field terminals.

WIRING INSTRUCTIONS

■ APPLICABLE WIRE SIZE

- **Solid:** 0.2 to 1.0 mm² (0.55 to 1.12 dia.)
- **Stranded:** 0.2 to 1.5 mm²

(Tinning wire ends may cause contact failure and therefore is not recommended.)

• Ferruled:

Unsheathed: 0.25 to 1.5 mm²

Sheathed: 0.25 to 0.75 mm²

- Expose wire conductors by 10 mm (0.39").

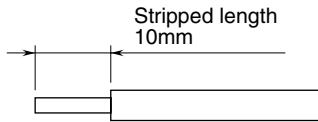

■ CONNECTION PROCEDURE

Insert the wire end until it comes to a full stop while pushing slot with the tip of a screw driver as shown below. Be sure wire insulation is not inside the terminal.

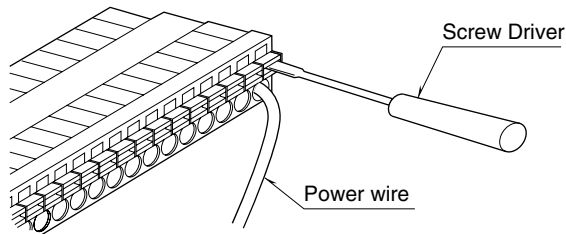

OUTPUT PIN ASSIGNMENT

PIN No.	FUNCTION
1	I1
2	COM1
3	NC
4	SLD
5	I2
6	COM2
7	NC
8	SLD
9	NC
10	NC
11	I3
12	COM3
13	NC
14	SLD
15	I4
16	COM4
17	NC
18	SLD
19	SLD
20	SLD

FUNCTIONS

■ OUTPUT HOLD or OUTPUT OFF

In normal conditions, the module outputs the signal from the preferred bus A.

When an error is detected, the output is switched to the data from the bus B.

• Output Hold

If both are in error, the module holds the signal and stands by until one of the communications recovers.

• Output OFF

If both are in error, the module outputs -15 % and stands by until one of the communications recovers.

At the startup, it outputs -15 % until the communication is established and normal data is received.