

BEFORE USE

Thank you for choosing M-System. Before use, please check contents of the package you received as outlined below. If you have any problems or questions with the product, please contact M-System's Sales Office or representatives.

■ PACKAGE INCLUDES:

Base(1)

■ MODEL NO.

Confirm Model No. marking on the product to be exactly what you ordered.

■ INSTRUCTION MANUAL

This manual describes necessary points of caution when you use this product, including installation, connection and basic maintenance procedures.

POINTS OF CAUTION

■ CONFORMITY WITH EU DIRECTIVES

- The equipment must be mounted inside the instrument panel of a metal enclosure.
- The actual installation environments such as panel configurations, connected devices, connected wires, may affect the protection level of this unit when it is integrated in a panel system. The user may have to review the CE requirements in regard to the whole system and employ additional protective measures to ensure the CE conformity.

■ GENERAL PRECAUTIONS

- Before you remove the base or mount it, turn off the power supply for safety.

■ ENVIRONMENT

- Indoor use.
- When heavy dust or metal particles are present in the air, install the unit inside proper housing with sufficient ventilation.
- Do not install the unit where it is subjected to continuous vibration. Do not subject the unit to physical impact.
- Environmental temperature must be within -10 to +55°C (14 to 131°F) with relative humidity within 30 to 90% RH in order to ensure adequate life span and operation.

■ WIRING

- Do not install cables close to noise sources (relay drive cable, high frequency line, etc.).
- Do not bind these cables together with those in which noises are present. Do not install them in the same duct.

FRONT VIEW

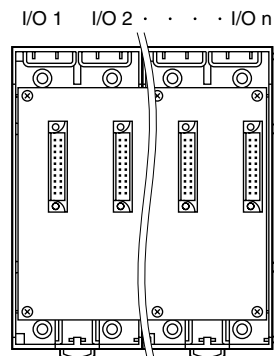

Mount the I/O Modules from the left end (I/O 1) to the right in order that the Network Module assigns data areas from I/O 1.

Be sure to install a network module on the right side of the I/O modules. For a power supply module, be sure to install in the right end slot for heat dissipation. In the case of redundant power supply, consecutively install them in the right end slot.

INSTALLATION

■ MOUNTING DIRECTION

The unit must be mounted on a vertical panel. Mounting in any other angle will cause internal temperature to rise, may shorten the product's life expectation or deteriorate its performance.

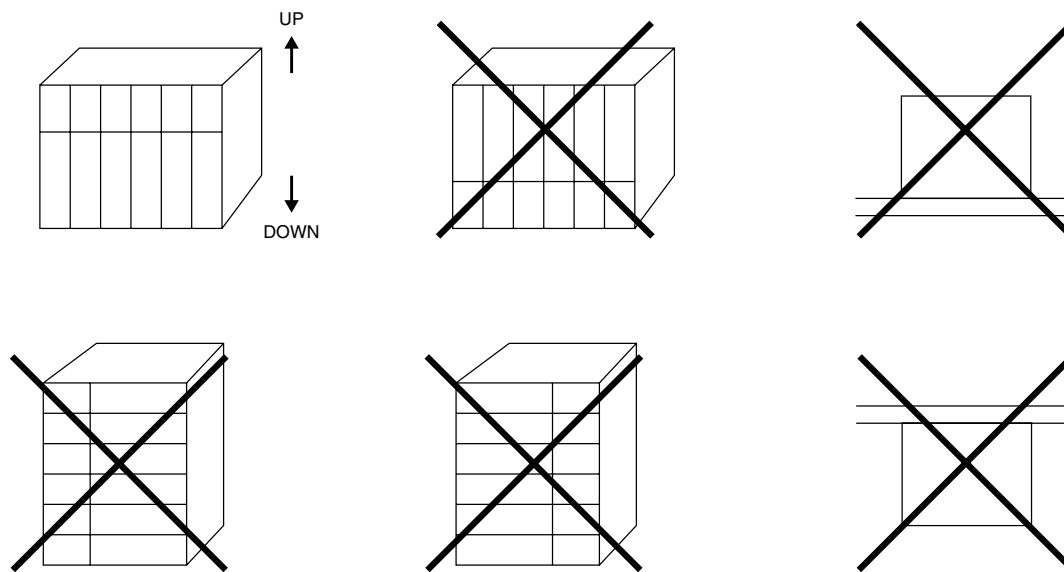

■ VENTILATION & MAINTENANCE SPACE

Maintain sufficient ventilation space. Do not mount the unit directly above devices which radiate great heat such as heaters, transformers or resistors.

Maintenance space is also required above and below the unit.

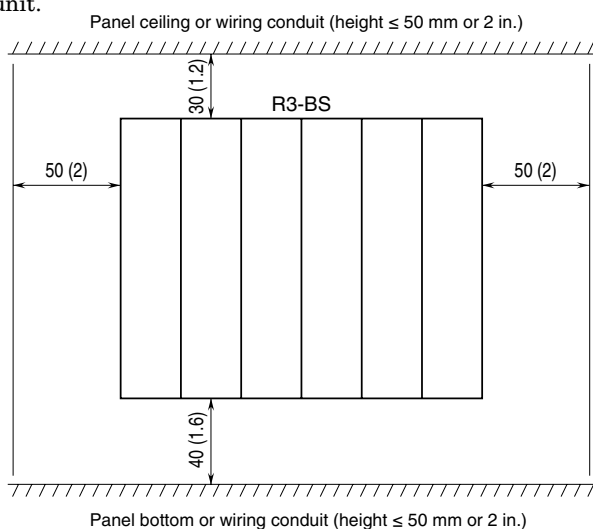

■ DIN RAIL MOUNTING

Set the base so that its mounting adaptor is at the bottom.

Pull out the adaptor and hung the upper hook at the rear side of base on the DIN rail.

Push in the lower and retract the adaptor, in keeping pressing the base to the DIN rail.

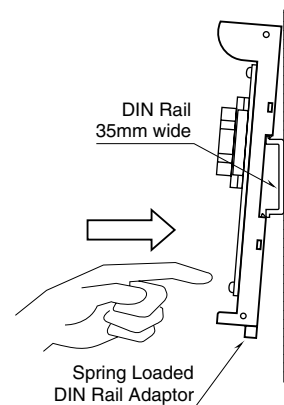

■ WALL MOUNTING unit: mm (inch)

• R3-BS02, BS02P

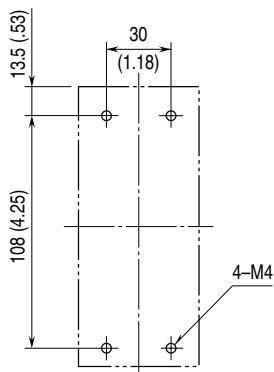

• R3-BS04, BS06, BS08, BS10, BS12, BS14, BS16

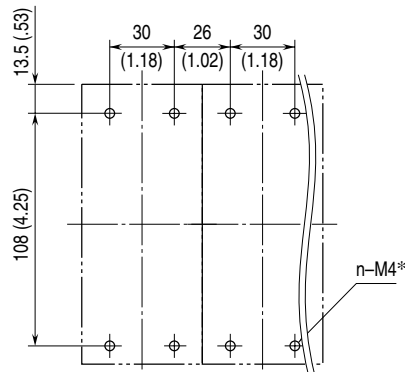

*n = Number of slots x 2

EXTERNAL DIMENSIONS unit: mm (inch)

■ R3-BS02, BS02P

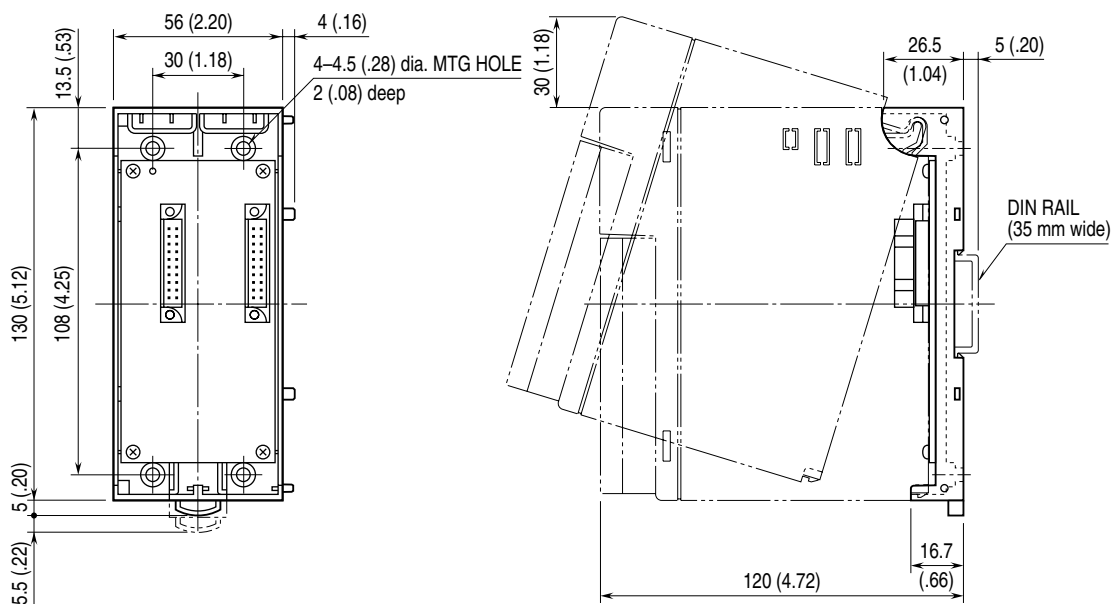

■ R3-BS04, BS06, BS08, BS10, BS12, BS14, BS16

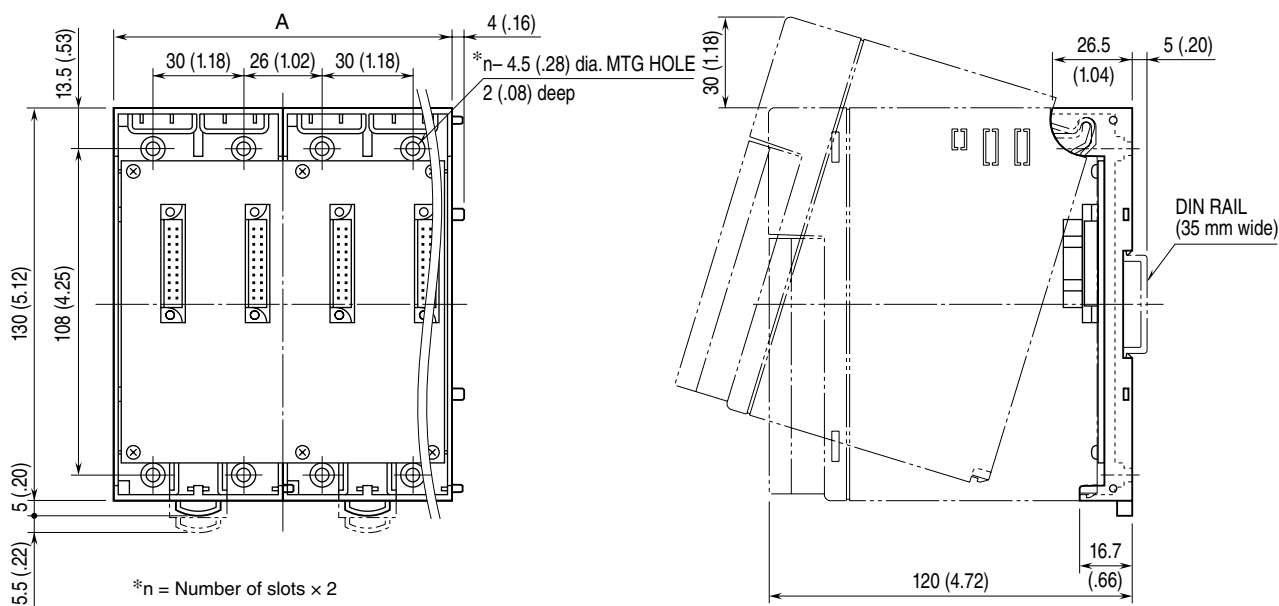

MODEL	SIZE	A
R3-BS04		112 (4.40)
R3-BS06		168 (6.61)
R3-BS08		224 (8.82)
R3-BS10		280 (11.02)
R3-BS12		336 (13.23)
R3-BS14		392 (15.43)
R3-BS16		448 (17.64)