

<p><b>FREQUENCY TRANSMITTER</b> (field-programmable)</p>	<p>MODEL <b>JPA</b></p>
--	-------------------------

**BEFORE USE ....**

Thank you for choosing M-System. Before use, please check contents of the package you received as outlined below. If you have any problems or questions with the product, please contact M-System's Sales Office or representatives.

**■ PACKAGE INCLUDES:**

Signal conditioner (body + base socket).....(1)

**■ MODEL NO.**

Confirm Model No. marking on the product to be exactly what you ordered.

**■ INSTRUCTION MANUAL**

This manual describes necessary points of caution when you use this product, including installation, connection, hardware setting and basic maintenance procedures. When you need to change software settings, please refer to the Operation Manual for Model PU-2x (EM-9255), Section A.

**POINTS OF CAUTION**

**■ POWER INPUT RATING & OPERATIONAL RANGE**

- Locate the power input rating marked on the product and confirm its operational range as indicated below:  
**AC power:** Rating  $\pm 10\%$ , 50/60  $\pm 2$  Hz, approx. 3VA  
**DC power:** Rating  $\pm 10\%$ , approx. 2W

**■ GENERAL PRECAUTIONS**

- Before you remove the unit from its base socket or mount it, turn off the power supply and input signal for safety.

**■ ENVIRONMENT**

- Indoor use.
- When heavy dust or metal particles are present in the air, install the unit inside a proper housing with sufficient ventilation.
- Do not install the unit where it is subjected to continuous vibration. Do not subject the unit to physical impact.
- Environmental temperature must be within  $-5$  to  $+55^{\circ}\text{C}$  ( $23$  to  $131^{\circ}\text{F}$ ) with relative humidity within 30 to 90% RH in order to ensure adequate life span and operation.

**■ WIRING**

- Do not install cables close to noise sources (relay drive cable, high frequency line, etc.).
- Do not bind these cables together with those in which noises are present. Do not install them in the same duct.

**■ AND ....**

- The unit is designed to function as soon as power is supplied, however, a warm up for 10 minutes is required for satisfying complete performance described in the data sheet.

**COMPONENT IDENTIFICATION**

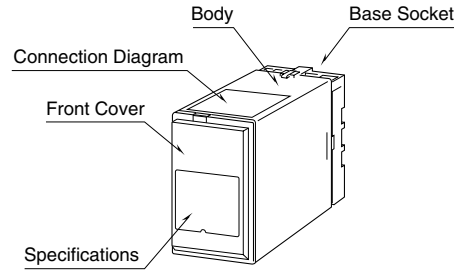

**■ HOW TO OPEN THE FRONT COVER:**

Hang your finger on the hook at the top of the front cover and pull.

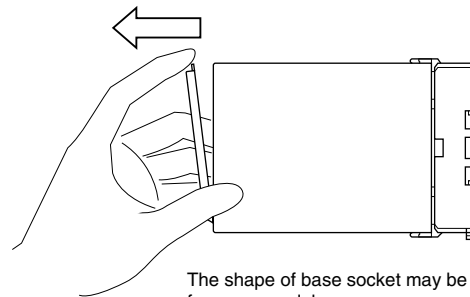

The shape of base socket may be different for some models.

**■ FRONT PANEL CONFIGURATIONS**

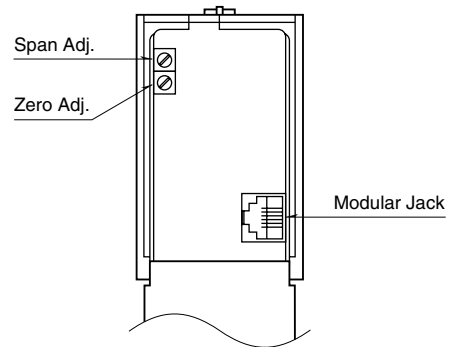

## INSTALLATION

Detach the yellow clamps located at the top and bottom of the unit for separate the body from the base socket.

### ■ DIN RAIL MOUNTING

Set the base socket so that its DIN rail adaptor is at the bottom. Hang the upper hook at the rear side of base socket on the DIN rail and push in the lower. When removing the socket, push down the DIN rail adaptor utilizing a minus screwdriver and pull.

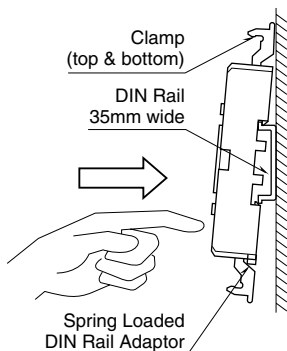

### ■ WALL MOUNTING

Refer to “EXTERNAL DIMENSIONS.”

Shape and size of the base socket are slightly different with various socket types.

## TERMINAL CONNECTIONS

Connect the unit as in the diagram below or refer to the connection diagram on the top of the unit.

### ■ EXTERNAL DIMENSIONS unit: mm (inch)

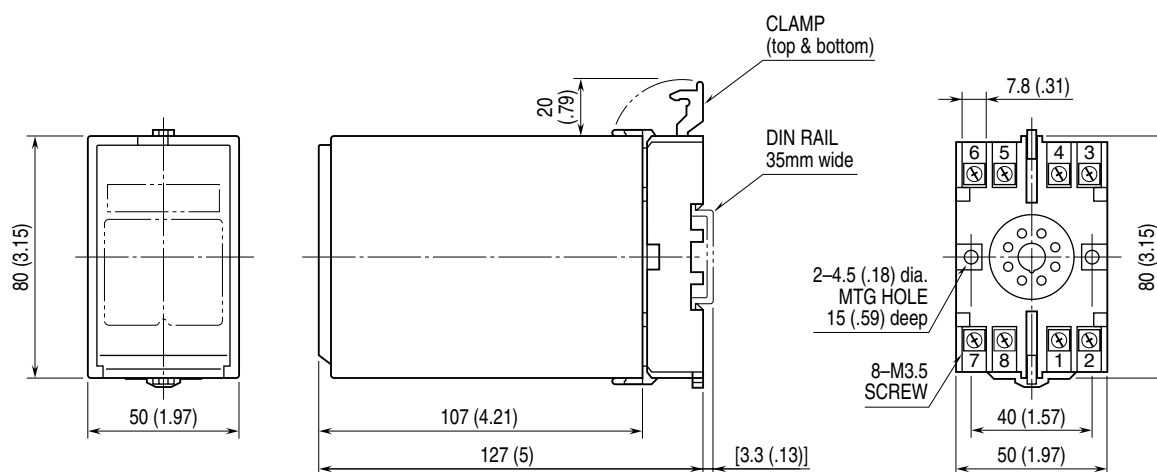

• When mounting, no extra space is needed between units.

### ■ CONNECTION DIAGRAM

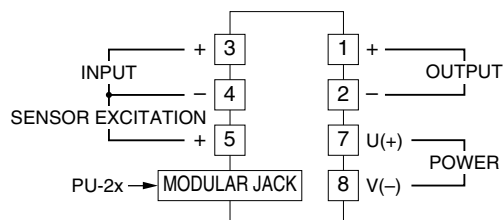

#### Input Connection Examples

■ Open Collector or Mechanical Contact    ■ Voltage Pulse

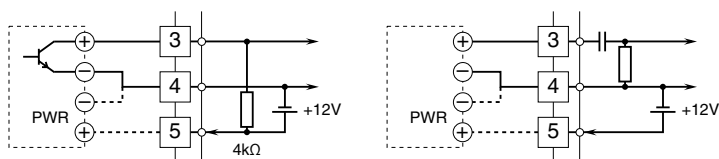

## CHECKING

- 1) Terminal wiring: Check that all cables are correctly connected according to the connection diagram.
- 2) Power input voltage: Check voltage across the terminal 7 – 8 with a multimeter.
- 3) Input: Check that the input signal is within 0 – 100% of the full-scale.
- 4) Output: Check that the load resistance meets the described specifications.

## ADJUSTMENT PROCEDURE

This unit is calibrated at the factory to meet the ordered specifications, therefore you usually do not need any calibration, unless you need to match the signal to a receiving instrument or conduct regular calibration.

Zero and span are adjusted with using the Programming Unit (model: PU-2x). Also, fine adjustments can be done with the potentiometers behind the front cover.

Refer to the Operation Manual for Model PU-2x for explanations how to use the programmer.

### ■ WARNING ON USE OF THE PROGRAMMING UNIT

- Be sure to disconnect the Programming Unit before you turn on/off power supply to the unit.
- The output signal is held when the Programming Unit is connected. You need to disconnect when confirming current output values.

### ■ HOW TO CALIBRATE THE OUTPUT SIGNAL

Use a signal source and measuring instruments of sufficient accuracy level. Turn the power supply on and warm up for more than 10 minutes.

#### • Fine Output Calibration

##### Using the Programming Unit (ITEM 19, 20)

ITEM 19 is for Zero, and ITEM 20 is for Span.

- 1) Turn the unit into Program mode (ITEM 01).
- 2) Apply simulated 0% input. Increase/decrease values (default: 0%) at ITEM 19 until the output signal is calibrated to actual 0%.
- 3) Apply simulated 100% input. Increase/decrease value (default: 100%) at ITEM 20 until the output signal is calibrated to actual 100%.
- 4) Apply simulated 0% input again and check 0% output.
- 5) When 0% value is changed, repeat the above procedure 2) – 4).

The 0% value may be shifted when the output span is greater than the input span (gain > 1).

#### • Fine Output Calibration via the Front Potentiometers

- 1) ZERO: Apply 0% input and adjust output to 0%.
- 2) SPAN: Apply 100% input and adjust output to 100%.
- 3) Check ZERO adjustment again with 0% input.
- 4) When ZERO value is changed, repeat the above procedure 1) – 3).

### • Using Linearization Table

Please have the PU-2x Operation Manual ready at hand. Max. 16 calibration points defined by sets of input and output values can be programmed. Use only necessary number of points, arranged in order from the smallest input value. Enable use of the linearization table (ITEM 10: PA-2: curved) in order to activate the settings.

X (nn) : Input Signal in %  
Y (nn) : Output Signal in %  
X or Y : -15.00 to +115.00%

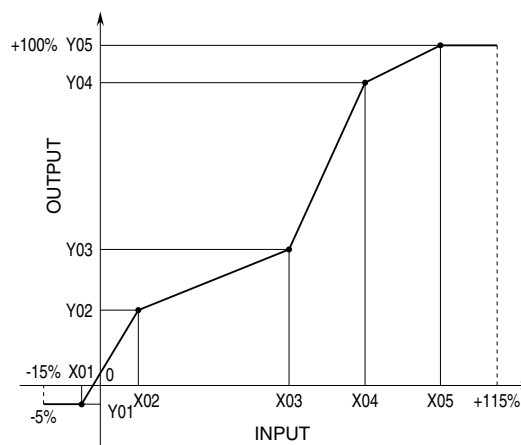

Figure 1. Linearization Table

### [GROUP 01]

ITEM	MDFY.	DATA EXAMPLE
60	P	X (01) : XXX.XX
61	P	Y (01) : XXX.XX
62	P	X (02) : XXX.XX
63	P	Y (02) : XXX.XX
64	P	X (03) : XXX.XX
65	P	Y (03) : XXX.XX
66	P	X (04) : XXX.XX
67	P	Y (04) : XXX.XX
68	P	X (05) : XXX.XX
69	P	Y (05) : XXX.XX
70	P	X (06) : XXX.XX
71	P	Y (06) : XXX.XX
72	P	X (07) : XXX.XX
73	P	Y (07) : XXX.XX
74	P	X (08) : XXX.XX
75	P	Y (08) : XXX.XX
76	P	X (09) : XXX.XX
77	P	Y (09) : XXX.XX
78	P	X (10) : XXX.XX
79	P	Y (10) : XXX.XX
80	P	X (11) : XXX.XX
81	P	Y (11) : XXX.XX
82	P	X (12) : XXX.XX
83	P	Y (12) : XXX.XX
84	P	X (13) : XXX.XX
85	P	Y (13) : XXX.XX
86	P	X (14) : XXX.XX
87	P	Y (14) : XXX.XX
88	P	X (15) : XXX.XX
89	P	Y (15) : XXX.XX
90	P	X (16) : XXX.XX
91	P	Y (16) : XXX.XX

### Modification Code

S: Modifiable at any time.

P: Modifiable only when the MAINTENANCE SWITCH is in the "PRG" mode.

## PROGRAMMABLE ITEMS

The following items can be monitored and programmed. For detailed explanations, please refer to the Operation Manual for Model PU-2x (EM-9255), Section A.

### [GROUP 01]

ITEM	MDFY.	DATA INPUT	DISPLAY	CONTENTS
01	S			MAINTENANCE SWITCH (lock command)
		0	MTSW: MON.MODE	MONITOR mode: data monitoring only
		1	MTSW: PRG.MODE	PROGRAM mode: "P" marked data modifiable
02	P	Alphabets & No.	TG: XXXXXXXXXXX	Tag name entry (10 characters max.)
03	P	Number (%)	OUTPER XXX.XX	Output status monitor (%) & simulation output
05	D	No input	INPPER XXX.XX	Input status monitor (%)
06	D	No input	INPFRQ XXXXXX	Input frequency monitor, same unit as selected in ITEM 11
10	P			LINEARIZATION
		1	PA-1: straight	Without
		2	PA-2: curved	With (ITEM 60 to 91 for data input)
11	P			COARSE FREQUENCY RANGE SELECTION
		0	FRQRNG: 10mHz	0 – 10 mHz
		1	FRQRNG: 100mHz	0 – 100 mHz
		2	FRQRNG: 1.0Hz	0 – 1 Hz
		3	FRQRNG: 10Hz	0 – 10 Hz
		4	FRQRNG: 100Hz	0 – 100 Hz
		5	FRQRNG: 1.0kHz	0 – 1 kHz
		6	FRQRNG: 10kHz	0 – 10 kHz
7	FRQRNG: 100kHz	0 – 100 kHz		
13	P	Percentage	DRPOUT XXX.XX	Low-end cutout adjustment, 0.00 – 100.00%
14	P	Actual value	SCLLOW XXXXXX	Input range scaling 0% value
15	P	Actual value	SCLHIG XXXXXX	Input range scaling 100% value Up to 150% of the coarse range selected in ITEM 11. Use the same unit.
18	P	Number	SMPLRATE XXX	Sampling rate modification for irregular pulse input (No. of pulses to be counted during one rotation of input flowmeter) Frequency range ≤ 100 Hz: 1 – 255 Frequency range 0 – 1 kHz: 1 – 25 Frequency range 0 – 10 kHz: 1 – 2
19	P	Percentage	FINZER	Fine zero adjustment Initial status shows actual bias (%). When data is entered, output (%) is shown.
20	P	Percentage	FINSFN	Fine span adjustment Initial status shows actual gain (%). When data is entered, output (%) is shown.

### LINEARIZATION TABLE

60	P	Percentage	X (01) : XXX.XX	Input 1
61	P	Percentage	Y (01) : XXX.XX	Output 1
:	:	:	:	:
:	:	:	:	:
91	P	Percentage	Y (16) : XXX.XX	Output 16

#### Modification Code

D: No modification (writing) possible. Used only for monitoring (reading).

S: Modifiable at any time.

P: Modifiable only when the MAINTENANCE SWITCH is in the "PRG" mode.

---

## MAINTENANCE

Regular calibration procedure is explained below:

### ■ CALIBRATION

Warm up the unit for at least 10 minutes. Apply 0%, 25%, 50%, 75% and 100% input signal. Check that the output signal for the respective input signal remains within accuracy described in the data sheet. When the output is out of tolerance, recalibrate the unit according to the "ADJUSTMENT PROCEDURE" explained earlier.

---

## LIGHTNING SURGE PROTECTION

M-System offers a series of lightning surge protector for protection against induced lightning surges. Please contact M-System to choose appropriate models.