

Limit Alarms (rotary switch adj.) AL-UNIT

FREQUENCY ALARM

(50 Hz minimum)

Functions & Features

- Providing SPDT relay outputs at preset frequency levels
- Dual (Hi/Lo) trip
- Low-end cutout
- Energized or de-energized coil at a tripped condition selectable
- Rotary switch setpoint adjustments
- Enclosed relays
- Relays can be powered 110 V DC
- High-density mounting

Typical Applications

- Annunciator
- Various alarm applications

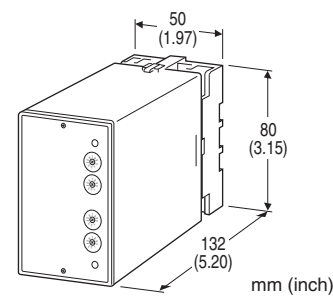

MODEL: ALSP-[1][2][3]-[4][5]

ORDERING INFORMATION

- Code number: ALSP-[1][2][3]-[4][5]
- Specify a code from below for each of [1] through [5]. (e.g. ALSP-111-B/Q)
- Frequency range (e.g. 0 - 500 Hz)
- Specify the specification for option code /Q (e.g. /C01/S01)

[1] INPUT

- 1: Dry contact
- 2: Voltage pulse

[2] SETPOINT 1 OUTPUT

- 1: Hi (coil energized at alarm)
- 2: Hi (coil de-energized at alarm)
- 3: Lo (coil energized at alarm)
- 4: Lo (coil de-energized at alarm)

[3] SETPOINT 2 OUTPUT

- 1: Hi (coil energized at alarm)
- 2: Hi (coil de-energized at alarm)
- 3: Lo (coil energized at alarm)
- 4: Lo (coil de-energized at alarm)

[4] POWER INPUT

- AC Power
- B: 100 V AC
- C: 110 V AC
- D: 115 V AC
- F: 120 V AC
- G: 200 V AC
- H: 220 V AC
- J: 240 V AC
- DC Power
- S: 12 V DC
- R: 24 V DC
- V: 48 V DC
- P: 110 V DC

[5] OPTIONS

- blank: none
- /Q: With options (specify the specification)

SPECIFICATIONS OF OPTION: Q (multiple selections)

- COATING (For the detail, refer to our web site.)
- /C01: Silicone coating
- /C02: Polyurethane coating
- /C03: Rubber coating
- TERMINAL SCREW MATERIAL
- /S01: Stainless steel

GENERAL SPECIFICATIONS

- Construction:** Plug-in
- Connection:** M3.5 screw terminals
- Screw terminal:** Chromated steel (standard) or stainless steel
- Housing material:** Flame-resistant resin (black)
- Isolation:** Input to output 1 to output 2 to power
- Setpoint adjustments:** 10-position rotary switches (front); 0 - 99 % independently; 1 % increments
- Remark:** The ALSP has low-end cutout function below 2 - 5 % input. A setpoint below this equals 0 %.
- Hysteresis (deadband):** 0.7 - 2.5 %
- Front LEDs:** Red LED turns on when the coil is energized.
- Power ON timer:** Relays de-energized for approx. 2 seconds after power is turned on.
- Low-end cutout:** 2 to 5 %

INPUT SPECIFICATIONS

Frequency range: 0 – 50 Hz through 10 kHz
Pulse width (time) requirement: Duty ratio 20 – 80 % at 100 % input
■ Dry Contact: Mechanical contact or open collector
Sensing: Approx. 7.5 V DC @1 mA
ON/OFF level: ≤ 200 Ω / 0.6 V for ON, ≥ 100 kΩ / 2 V for OFF
■ Voltage Pulse: Square or sine waveforms
Input pulse sensing: Capacitor coupled; detecting pulse rise
Input amplitude: 2 – 50 Vp-p
Input impedance: 100 kΩ min.

OUTPUT SPECIFICATIONS

■ Relay Contact: 100 V AC @ 1 A ($\cos \phi = 1$)
 120 V AC @ 1 A ($\cos \phi = 1$)
 240 V AC @ 0.5 A ($\cos \phi = 1$)
 30 V DC @ 1 A (resistive load)
Maximum switching voltage: 380 V AC or 125 V DC
Maximum switching power: 120 VA or 30 W
Minimum load: 5 V DC @ 10 mA
Mechanical life: 5×10^7 cycles
 For maximum relay life with inductive loads, external protection is recommended.

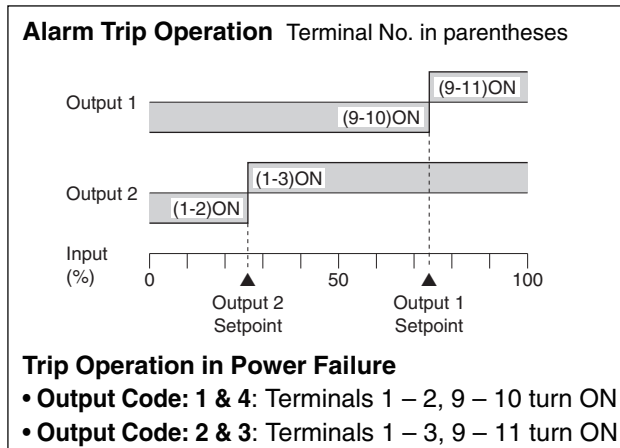

INSTALLATION

Power input

- **AC:** Operational voltage range: rating ± 10 %, 50/60 ± 2 Hz, approx. 2 VA
- **DC:** Operational voltage range: rating ± 10 %, or 85 – 150 V for 110 V rating (ripple 10 % p-p max.) approx. 2 W (80 mA at 24 V)

Operating temperature: -5 to +60°C (23 to 140°F)
Operating humidity: 30 to 90 %RH (non-condensing)
Mounting: Surface or DIN rail
Weight: 370 g (0.82 lb)

PERFORMANCE in percentage of span

Setpoint accuracy: ± 0.7 %
Trip point repeatability: ± 0.05 %
Temp. coefficient: ± 0.015 %/°C (± 0.008 %/°F)
Response time: (0 – 100 % at 90 % setpoint)
 approx. 2 seconds for 0 – 50 Hz
 approx. 1 second for 0 – 100 Hz
 approx. 0.5 seconds for 0 – 500 Hz
 approx. 0.5 seconds for 0 – 10 kHz
Line voltage effect: ± 0.1 % over voltage range
Insulation resistance: ≥ 100 MΩ with 500 V DC
Dielectric strength: 2000 V AC @1 minute (input to output 1 to output 2 to power to ground)

EXTERNAL VIEW

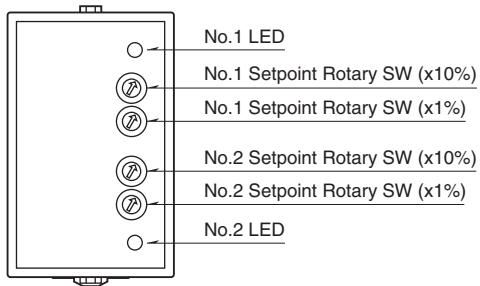

EXTERNAL DIMENSIONS & TERMINAL ASSIGNMENTS unit: mm [inch]

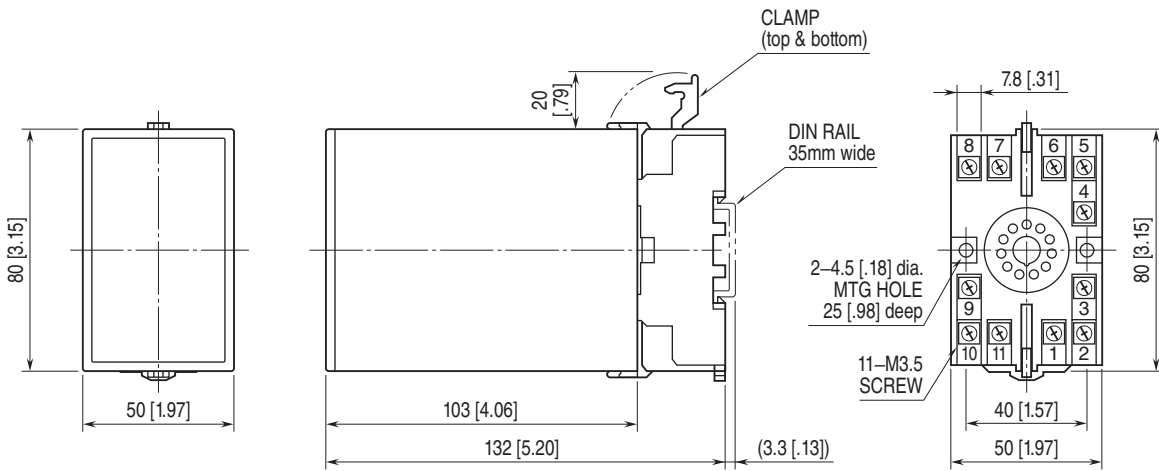

• When mounting, no extra space is needed between units.

SCHEMATIC CIRCUITRY & CONNECTION DIAGRAM

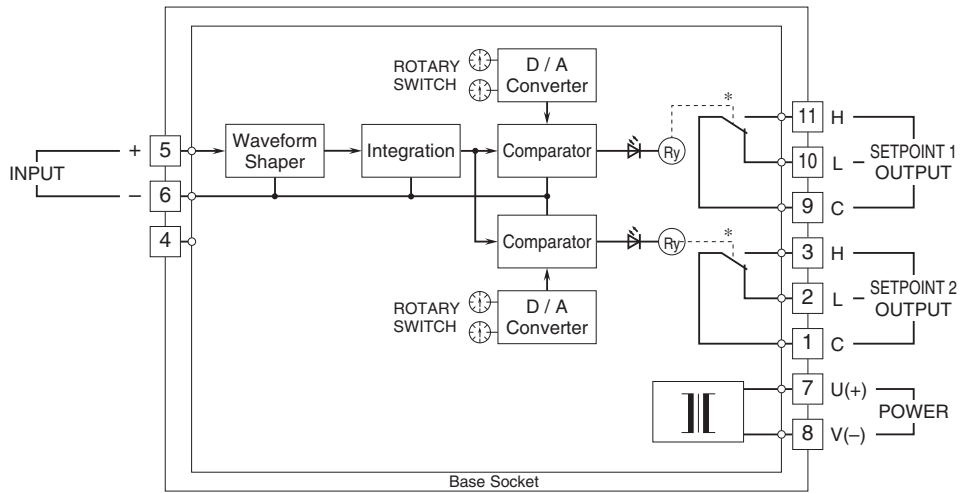

*Relay status for output codes "1" & "4", at power OFF.

Input Connection Examples

■ Dry Contact

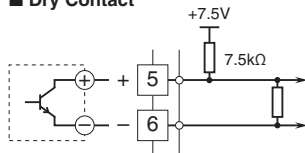

■ Voltage Pulse

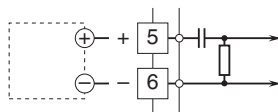

■ Relay Protection

• AC Powered

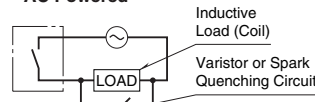

• DC Powered

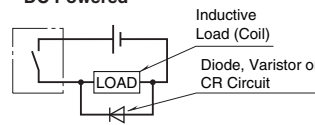

Specifications are subject to change without notice.